

2019 ESC Guidelines for the diagnosis and management of chronic coronary syndromes

The Task Force for the diagnosis and management of chronic coronary syndromes of the European Society of Cardiology (ESC)

Authors/Task Force Members: Juhani Knuuti* (Finland) (Chairperson), William Wijns* (Ireland) (Chairperson), Antti Saraste (Finland), Davide Capodanno (Italy), Emanuele Barbato (Italy), Christian Funck-Brentano (France), Eva Prescott (Denmark), Robert F. Storey (United Kingdom), Christi Deaton (United Kingdom), Thomas Cuisset (France), Stefan Agewall (Norway), Kenneth Dickstein (Norway), Thor Edvardsen (Norway), Javier Escaned (Spain), Bernard J. Gersh (United States of America), Pavel Svitol (Czech Republic), Martine Gilard (France), David Hasdai (Israel), Robert Hatala (Slovak Republic), Felix Mahfoud (Germany), Josep Masip (Spain), Claudio Muneretto (Italy), Marco Valgimigli (Switzerland), Stephan Achenbach (Germany), and Jeroen J. Bax (Netherlands)

Document Reviewers: Franz-Josef Neumann (Germany) (CPG Review Coordinator), Udo Sechtem (Germany) (CPG Review Coordinator), Adrian Paul Banning (United Kingdom), Nikolaos Bonaros (Austria), Héctor Bueno (Spain), Raffaele Bugiardini (Italy), Alaide Chieffo (Italy), Filippo Crea (Italy), Martin Czerny (Germany), Victoria Delgado (Netherlands), Paul Dendale (Belgium),

* Corresponding authors: Juhani Knuuti, Department of Clinical Physiology, Nuclear Medicine and PET and Turku PET Centre, Turku University Hospital, Kiinamyllykatu 4-8, FI-20520 Turku, Finland. Tel: +358 500 592 998, Email: juhani.knuuti@tyks.fi. William Wijns, The Lambe Institute for Translational Medicine and Curam, National University of Ireland, Galway, University Road, Galway, H91 TK33, Ireland. Tel: +353 91 524411, Email: william.wjns@nuigalway.ie.

Author/Task Force Member Affiliations: listed in the Appendix.

ESC Committee for Practice Guidelines (CPG) and National Cardiac Societies document reviewers: listed in the Appendix.

ESC entities having participated in the development of this document:

Associations: Acute Cardiovascular Care Association (ACCA), Association of Cardiovascular Nursing & Allied Professions (ACNAP), European Association of Cardiovascular Imaging (EACVI), European Association of Preventive Cardiology (EAPC), European Association of Percutaneous Cardiovascular Interventions (EAPCI), European Heart Rhythm Association (EHRA), Heart Failure Association (HFA).

Councils: Council for Cardiology Practice.

Working Groups: Atherosclerosis and Vascular Biology, Cardiovascular Pharmacotherapy, Cardiovascular Surgery, Coronary Pathophysiology and Microcirculation, Thrombosis.

The content of these ESC Guidelines has been published for personal and educational use only. No commercial use is authorized. No part of the ESC Guidelines may be translated or reproduced in any form without written permission from the ESC. Permission can be obtained upon submission of a written request to Oxford University Press, the publisher of the *European Heart Journal* and the party authorized to handle such permissions on behalf of the ESC (journals.permissions@oxfordjournals.org).

Disclaimer. The ESC Guidelines represent the views of the ESC and were produced after careful consideration of the scientific and medical knowledge, and the evidence available at the time of their publication. The ESC is not responsible in the event of any contradiction, discrepancy, and/or ambiguity between the ESC Guidelines and any other official recommendations or guidelines issued by the relevant public health authorities, in particular in relation to good use of healthcare or therapeutic strategies. Health professionals are encouraged to take the ESC Guidelines fully into account when exercising their clinical judgment, as well as in the determination and the implementation of preventive, diagnostic, or therapeutic medical strategies; however, the ESC Guidelines do not override, in any way whatsoever, the individual responsibility of health professionals to make appropriate and accurate decisions in consideration of each patient's health condition and in consultation with that patient and, where appropriate and/or necessary, the patient's caregiver. Nor do the ESC Guidelines exempt health professionals from taking into full and careful consideration the relevant official updated recommendations or guidelines issued by the competent public health authorities, in order to manage each patient's case in light of the scientifically accepted data pursuant to their respective ethical and professional obligations. It is also the health professional's responsibility to verify the applicable rules and regulations relating to drugs and medical devices at the time of prescription.

© The European Society of Cardiology 2019. All rights reserved. For permissions please email: journals.permissions@oup.com.

Frank Arnold Flachskampf (Sweden), Helmut Gohlke (Germany), Erik Lerkevang Grove (Denmark), Stefan James (Sweden), Demosthenes Katritsis (Greece), Ulf Landmesser (Germany), Maddalena Lettino (Italy), Christian M. Matter (Switzerland), Hendrik Nathoe (Netherlands), Alexander Niessner (Austria), Carlo Patrono (Italy), Anna Sonia Petronio (Italy), Steffen E. Pettersen (United Kingdom), Raffaele Piccolo (Italy), Massimo Francesco Piepoli (Italy), Bogdan A. Popescu (Romania), Lorenz Räber (Switzerland), Dimitrios J. Richter (Greece), Marco Roffi (Switzerland), Franz X. Roithinger (Austria), Evgeny Shlyakhto (Russian Federation), Dirk Sibbing (Germany), Sigmund Silber (Germany), Iain A. Simpson (United Kingdom), Miguel Sousa-Uva (Portugal), Panos Vardas (Greece), Adam Witkowski (Poland), Jose Luis Zamorano (Spain)

The disclosure forms of all experts involved in the development of these Guidelines are available on the ESC website www.escardio.org/guidelines

SD For the Supplementary Data which include background information and detailed discussion of the data that have provided the basis for the Guidelines see <https://academic.oup.com/eurheartj/article-lookup/doi/10.1093/eurheartj/ehz425#supplementary-data>

Online publish-ahead-of-print 31 August 2019

Keywords

Guidelines • chronic coronary syndromes • angina pectoris • myocardial ischaemia • coronary artery disease • diagnostic testing • imaging • risk assessment • lifestyle modifications • anti-ischaemic drugs • antithrombotic therapy • lipid-lowering drugs • myocardial revascularization • microvascular angina • vasospastic angina • screening

Table of contents

1. Preamble	411	3.1.6.1 Definition of levels of risk	428
2. Introduction	413	3.2 Lifestyle management	429
2.1 What is new in the 2019 Guidelines?	414	3.2.1 General management of patients with coronary artery disease	429
3. Patients with angina and/or dyspnoea, and suspected coronary artery disease	416	3.2.2 Lifestyle modification and control of risk factors	429
3.1 Basic assessment, diagnosis, and risk assessment	416	3.2.2.1 Smoking	429
3.1.1 Step 1: symptoms and signs	417	3.2.2.2 Diet and alcohol	430
3.1.1.1 Stable vs. unstable angina	418	3.2.2.3 Weight management	430
3.1.1.2 Distinction between symptoms caused by epicardial vs. microvascular/vasospastic disease	419	3.2.2.4 Physical activity	430
3.1.2 Step 2: comorbidities and other causes of symptoms	419	3.2.2.5 Cardiac rehabilitation	430
3.1.3 Step 3: basic testing	419	3.2.2.6 Psychosocial factors	430
3.1.3.1 Biochemical tests	419	3.2.2.7 Environmental factors	431
3.1.3.2 Resting electrocardiogram and ambulatory monitoring	420	3.2.2.8 Sexual activity	431
3.1.3.3 Echocardiography and magnetic resonance imaging at rest	420	3.2.2.9 Adherence and sustainability	431
3.1.3.4 Chest X-ray	421	3.2.2.10 Influenza vaccination	431
3.1.4 Step 4: assess pre-test probability and clinical likelihood of coronary artery disease	421	3.3 Pharmacological management	432
3.1.5 Step 5: select appropriate testing	422	3.3.1 Anti-ischaemic drugs	432
3.1.5.1 Functional non-invasive tests	422	3.3.1.1 General strategy	432
3.1.5.2 Anatomical non-invasive evaluation	423	3.3.1.2 Available drugs	432
3.1.5.3 Role of the exercise electrocardiogram	423	3.3.1.3 Patients with low blood pressure	435
3.1.5.4 Selection of diagnostic tests	424	3.3.1.4 Patients with low heart rate	435
3.1.5.5 The impact of clinical likelihood on the selection of a diagnostic test	424	3.3.2 Event prevention	436
3.1.5.6 Invasive testing	425	3.3.2.1 Antiplatelet drugs	436
3.1.6 Step 6: assess event risk	427	3.3.2.2 Anticoagulant drugs in sinus rhythm	436
		3.3.2.3 Anticoagulant drugs in atrial fibrillation	437
		3.3.2.4 Proton pump inhibitors	437
		3.3.2.5 Cardiac surgery and antithrombotic therapy	437
		3.3.2.6 Non-cardiac surgery and antithrombotic therapy	438
		3.3.3 Statins and other lipid-lowering drugs	440
		3.3.4 Renin-angiotensin-aldosterone system blockers	440
		3.3.5 Hormone replacement therapy	441

3.4 Revascularization	441
4. Patients with new onset of heart failure or reduced left ventricular function	442
5. Patients with a long-standing diagnosis of chronic coronary syndromes	444
5.1 Patients with stabilized symptoms <1 year after an acute coronary syndrome or patients with recent revascularization	444
5.2 Patients >1 year after initial diagnosis or revascularization	444
6. Angina without obstructive disease in the epicardial coronary arteries	446
6.1 Microvascular angina	447
6.1.1 Risk stratification	447
6.1.2 Diagnosis	447
6.1.3 Treatment	447
6.2 Vasospastic angina	448
6.2.1 Diagnosis	448
6.2.2 Treatment	448
7. Screening for coronary artery disease in asymptomatic subjects ..	449
8. Chronic coronary syndromes in specific circumstances	450
8.1 Cardiovascular comorbidities	450
8.1.1 Hypertension	450
8.1.2 Valvular heart disease (including planned transcatheter aortic valve implantation)	450
8.1.3 After heart transplantation	450
8.2 Non-cardiovascular comorbidities	451
8.2.1 Cancer	451
8.2.2 Diabetes mellitus	451
8.2.3 Chronic kidney disease	452
8.2.4 Elderly	452
8.3 Sex	452
8.4 Patients with refractory angina	453
9. Key messages	454
10. Gaps in the evidence	455
10.1 Diagnosis and assessment	455
10.2 Assessment of risk	455
10.3 Lifestyle management	455
10.4 Pharmacological management	455
10.5 Revascularization	455
10.6 Heart failure and left ventricular dysfunction	455
10.7 Patients with long-standing diagnosis of chronic coronary syndromes	455
10.8 Angina without obstructive coronary artery disease	455
10.9 Screening in asymptomatic subjects	455
10.10 Comorbidities	456
10.11 Patients with refractory angina	456
11. 'What to do' and 'what not to do' messages from the Guidelines	456
12. Supplementary data	460
13. Appendix	460
14. References	461

Recommendations

2019 New major recommendations	414
Changes in major recommendations	416

Basic biochemistry testing in the initial diagnostic management of patients with suspected coronary artery disease	419
Resting electrocardiogram in the initial diagnostic management of patients with suspected coronary artery disease	420
Ambulatory electrocardiogram monitoring in the initial diagnostic management of patients with suspected coronary artery disease	420
Resting echocardiography and cardiac magnetic resonance in the initial diagnostic management of patients with suspected coronary artery disease	421
Chest X-ray in the initial diagnostic management of patients with suspected coronary artery disease	421
Use of diagnostic imaging tests in the initial diagnostic management of symptomatic patients with suspected coronary artery disease	426
Performing exercise electrocardiogram in the initial diagnostic management of patients with suspected coronary artery disease	426
Recommendations for risk assessment	428
Recommendations on lifestyle management	431
Recommendations on anti-ischaemic drugs in patients with chronic coronary syndromes	435
Recommendations for event prevention I	438
Recommendations for event prevention II	441
General recommendations for the management of patients with chronic coronary syndromes and symptomatic heart failure due to ischaemic cardiomyopathy and left ventricular systolic dysfunction	443
Recommendations for patients with a long-standing diagnosis of chronic coronary syndromes	446
Investigations in patients with suspected coronary microvascular angina	448
Recommendations for investigations in patients with suspected vasospastic angina	448
Recommendations for screening for coronary artery disease in asymptomatic subjects	449
Recommendations for hypertension treatment in chronic coronary syndromes	450
Recommendations for valvular disease in chronic coronary syndromes	450
Recommendations for active cancer in chronic coronary syndromes	451
Recommendations for diabetes mellitus in chronic coronary syndromes	451
Recommendations for chronic kidney disease in chronic coronary syndromes	452
Recommendations for elderly patients with chronic coronary syndromes	452
Recommendation for sex issues and chronic coronary syndromes	453
Recommendations for treatment options for refractory angina	454
Recommendations: 'what to do' and 'what not to do'	456

List of tables

Table 1 Classes of recommendations	412
Table 2 Levels of evidence	412

Table 3 Traditional clinical classification of suspected anginal symptoms	418
Table 4 Grading of effort angina severity according to the Canadian Cardiovascular Society	418
Table 5 Pre-test probabilities of obstructive coronary artery disease in 15 815 symptomatic patients according to age, sex, and the nature of symptoms in a pooled analysis of contemporary data	422
Table 6 Definitions of high event risk for different test modalities in patients with established chronic coronary syndromes	427
Table 7 Lifestyle recommendations for patients with chronic coronary syndromes.	429
Table 8 Healthy diet characteristics	430
Table 9 Treatment options for dual antithrombotic therapy in combination with aspirin 75-100 mg daily in alphabetical order in patients who have a high or moderate risk of ischaemic events, and do not have a high bleeding risk.	440
Table 10 Blood pressure thresholds for definition of hypertension with different types of blood pressure measurement	450
Table 11 Potential treatment options for refractory angina and summary of trial data	453

List of figures

Figure 1 Schematic illustration of the natural history of chronic coronary syndromes	413
Figure 2 Approach for the initial diagnostic management of patients with angina and suspected coronary artery disease	417
Figure 3 Determinants of clinical likelihood of obstructive coronary artery disease	423
Figure 4 Main diagnostic pathways in symptomatic patients with suspected obstructive coronary artery disease	424
Figure 5 Ranges of clinical likelihood of coronary artery disease in which the test can rule-in or rule-out obstructive coronary artery disease	425
Figure 6 Comparison of risk assessments in asymptomatic apparently healthy subjects (primary prevention) and patients with established chronic coronary syndromes (secondary prevention) ...	427
Figure 7 The five As of smoking cessation	430
Figure 8 Suggested stepwise strategy for long-term anti-ischaemic drug therapy in patients with chronic coronary syndromes and specific baseline characteristics	434
Figure 9 Decision tree for patients undergoing invasive coronary angiography	442
Figure 10 Proposed algorithm according to patient types commonly observed at chronic coronary syndrome outpatient clinics	445

Abbreviations and acronyms

ABI	Ankle-brachial index
ACE	Angiotensin-converting enzyme

ACS	Acute coronary syndrome(s)
ACTION	A Coronary disease Trial Investigating Outcome with Nifedipine gastrointestinal therapeutic system
AF	Atrial fibrillation
ARB	Angiotensin receptor blocker
AUGUSTUS	An Open-label, 2 × 2 Factorial, Randomized Controlled, Clinical Trial to Evaluate the Safety of Apixaban vs. Vitamin K Antagonist and Aspirin vs. Aspirin Placebo in Patients With Atrial Fibrillation and Acute Coronary Syndrome or Percutaneous Coronary Intervention
BARI-2D	Bypass Angioplasty Revascularization Investigation 2 Diabetes
BEAUTIFUL	I _f Inhibitor Ivabradine in Patients with Coronary Artery Disease and Left Ventricular Dysfunction
b.i.d.	Bis in die (twice a day)
BMI	Body mass index
BP	Blood pressure
b.p.m.	Beats per minute
CABG	Coronary artery bypass grafting
CAD	Coronary artery disease
CAPRIE	Clopidogrel vs. Aspirin in Patients at Risk of Ischaemic Events
CASS	Coronary Artery Surgery Study
CCB	Calcium channel blocker
CCS	Chronic coronary syndrome(s)
CFR	Coronary flow reserve
CHA ₂ DS ₂ -VASc	Cardiac failure, Hypertension, Age ≥75 [Doubled], Diabetes, Stroke [Doubled] – Vascular disease, Age 65–74 and Sex category [Female]
CHD	Coronary heart disease
CI	Confidence interval
CKD	Chronic kidney disease
CMR	Cardiac magnetic resonance
COMPASS	Cardiovascular Outcomes for People Using Anticoagulation Strategies
COURAGE	Clinical Outcomes Utilizing Revascularization and Aggressive Drug Evaluation
CPG	Committee for Practice Guidelines
CRT	Cardiac resynchronization therapy
CT	Computed tomography
CTA	Computed tomography angiography
CVD	Cardiovascular disease
DAPT	Dual antiplatelet therapy
DES	Drug-eluting stent(s)
DHP	Dihydropyridine
ECG	Electrocardiogram
eGFR	Estimated glomerular filtration rate
ESC	European Society of Cardiology
FAME 2	Fractional Flow Reserve versus Angiography for Multivessel Evaluation 2
FFR	Fractional flow reserve

FFR _{CT}	Computed tomography-based fractional flow reserve
GEMINI-ACS	A Study to Compare the Safety of Rivaroxaban Versus Acetylsalicylic Acid in Addition to Either Clopidogrel or Ticagrelor Therapy in Participants With Acute Coronary Syndrome
GFR	Glomerular filtration rate
GLS	Global longitudinal strain
GOSPEL	Global secondary prevention strategies to limit event recurrence after myocardial infarction
HbA1c	Glycated haemoglobin
HF	Heart failure
ICA	Invasive coronary angiography
IMR	Index of microcirculatory resistance
IMT	Intima-media thickness
IONA	Impact Of Nicorandil in Angina
iwFR	Instantaneous wave-free ratio (instant flow reserve)
LAD	Left anterior descending
LBBB	Left bundle branch block
LDL-C	Low-density lipoprotein cholesterol
LM	Left main (coronary artery)
LV	Left ventricular
LVEF	Left ventricular ejection fraction
MI	Myocardial infarction
MRA	Mineralocorticoid receptor antagonist
NOAC	Non-vitamin K antagonist oral anticoagulant
NT-proBNP	N-terminal pro-B-type natriuretic peptide
OAC	Oral anticoagulant
o.d.	Omni die (once a day)
ORBITA	Objective Randomised Blinded Investigation with optimal medical Therapy of Angioplasty in stable angina
PAD	Peripheral artery disease
PCI	Percutaneous coronary intervention
PCSK9	Proprotein convertase subtilisin-kexin type 9
PEGASUS-TIMI 54	Prevention of Cardiovascular Events in Patients with Prior Heart Attack Using Ticagrelor Compared to Placebo on a Background of Aspirin—Thrombolysis in Myocardial Infarction 54
PET	Positron emission tomography
PROMISE	Prospective Multicenter Imaging Study for Evaluation of Chest Pain
PTP	Pre-test probability
RAS	Renin-angiotensin system
RCT	Randomized clinical trial
REACH	Reduction of Atherothrombosis for Continued Health
RIVER-PCI	Ranolazine for Incomplete Vessel Revascularization Post-Percutaneous Coronary Intervention
SCORE	Systematic COronary Risk Evaluation
SCOT-HEART	Scottish Computed Tomography of the HEART

SIGNIFY	Study Assessing the Morbidity—Mortality Benefits of the If Inhibitor Ivabradine in Patients with Coronary Artery Disease
SPECT	Single-photon emission computed tomography
VKA	Vitamin K antagonist

1 Preamble

Guidelines summarize and evaluate available evidence with the aim of assisting health professionals in proposing the best management strategies for an individual patient with a given condition. Guidelines and their recommendations should facilitate decision making of health professionals in their daily practice. However, the final decisions concerning an individual patient must be made by the responsible health professional(s) in consultation with the patient and caregiver as appropriate.

A great number of guidelines have been issued in recent years by the European Society of Cardiology (ESC), as well as by other societies and organizations. Because of their impact on clinical practice, quality criteria for the development of guidelines have been established in order to make all decisions transparent to the user. The recommendations for formulating and issuing ESC Guidelines can be found on the ESC website (<http://www.escardio.org/Guidelines-&Education/Clinical-Practice-Guidelines/Guidelines-development/Writing-ESC-Guidelines>). The ESC Guidelines represent the official position of the ESC on a given topic and are regularly updated.

The ESC carries out a number of registries which are essential to assess, diagnostic/therapeutic processes, use of resources and adherence to Guidelines. These registries aim at providing a better understanding of medical practice in Europe and around the world, based on data collected during routine clinical practice.

The guidelines are developed together with derivative educational material addressing the cultural and professional needs for cardiologists and allied professionals. Collecting high-quality observational data, at appropriate time interval following the release of ESC Guidelines, will help evaluate the level of implementation of the Guidelines, checking in priority the key end points defined with the ESC Guidelines and Education Committees and Task Force members in charge.

The Members of this Task Force were selected by the ESC, including representation from its relevant ESC sub-specialty groups, in order to represent professionals involved with the medical care of patients with this pathology. Selected experts in the field undertook a comprehensive review of the published evidence for management of a given condition according to ESC Committee for Practice Guidelines (CPG) policy. A critical evaluation of diagnostic and therapeutic procedures was performed, including assessment of the risk/benefit ratio. The level of evidence and the strength of the recommendation of particular management options were weighed and graded according to predefined scales, as outlined in *Tables 1 and 2*.

The experts of the writing and reviewing panels provided declaration of interest forms for all relationships that might be perceived as

Table 1 Classes of recommendations

	Definition	Wording to use	
Classes of recommendations	Class I	Evidence and/or general agreement that a given treatment or procedure is beneficial, useful, effective.	Is recommended or is indicated
	Class II	Conflicting evidence and/or a divergence of opinion about the usefulness/efficacy of the given treatment or procedure.	
	Class IIa	Weight of evidence/opinion is in favour of usefulness/efficacy.	Should be considered
	Class IIb	Usefulness/efficacy is less well established by evidence/opinion.	May be considered
	Class III	Evidence or general agreement that the given treatment or procedure is not useful/effective, and in some cases may be harmful.	Is not recommended

©ESC 2019

Table 2 Levels of evidence

Level of evidence A	Data derived from multiple randomized clinical trials or meta-analyses.
Level of evidence B	Data derived from a single randomized clinical trial or large non-randomized studies.
Level of evidence C	Consensus of opinion of the experts and/or small studies, retrospective studies, registries.

©ESC 2019

real or potential sources of conflicts of interest. These forms were compiled into one file and can be found on the ESC website (<http://www.escardio.org/guidelines>). Any changes in declarations of interest that arise during the writing period were notified to the ESC and updated. The Task Force received its entire financial support from the ESC without any involvement from the healthcare industry.

The ESC CPG supervises and coordinates the preparation of new Guidelines. The Committee is also responsible for the

endorsement process of these Guidelines. The ESC Guidelines undergo extensive review by the CPG and external experts. After appropriate revisions the Guidelines are approved by all the experts involved in the Task Force. The finalized document is approved by the CPG for publication in the European Heart Journal. The Guidelines were developed after careful consideration of the scientific and medical knowledge and the evidence available at the time of their dating.

The task of developing ESC Guidelines also includes the creation of educational tools and implementation programmes for the recommendations including condensed pocket guideline versions, summary slides, booklets with essential messages, summary cards for non-specialists and an electronic version for digital applications (smartphones, etc.). These versions are abridged and thus, for more detailed information, the user should always access to the full text version of the Guidelines, which is freely available via the ESC website and hosted on the EHJ website. The National Societies of the ESC are encouraged to endorse, translate and implement all ESC Guidelines. Implementation programmes are needed because it has been shown that the outcome of disease may be favourably influenced by the thorough application of clinical recommendations.

Health professionals are encouraged to take the ESC Guidelines fully into account when exercising their clinical judgment, as well as in the determination and the implementation of preventive, diagnostic or therapeutic medical strategies. However, the ESC Guidelines do not override in any way whatsoever the individual responsibility of health professionals to make appropriate and accurate decisions in

consideration of each patient's health condition and in consultation with that patient or the patient's caregiver where appropriate and/or necessary. It is also the health professional's responsibility to verify the rules and regulations applicable in each country to drugs and devices at the time of prescription.

2 Introduction

Coronary artery disease (CAD) is a pathological process characterized by atherosclerotic plaque accumulation in the epicardial arteries, whether obstructive or non-obstructive. This process can be modified by lifestyle adjustments, pharmacological therapies, and invasive interventions designed to achieve disease stabilization or regression. The disease can have long, stable periods but can also become unstable at any time, typically due to an acute atherothrombotic event caused by plaque rupture or erosion. However, the disease is chronic, most often progressive, and hence serious, even in clinically apparently silent periods. The dynamic nature of the CAD process results in various clinical presentations, which can be conveniently

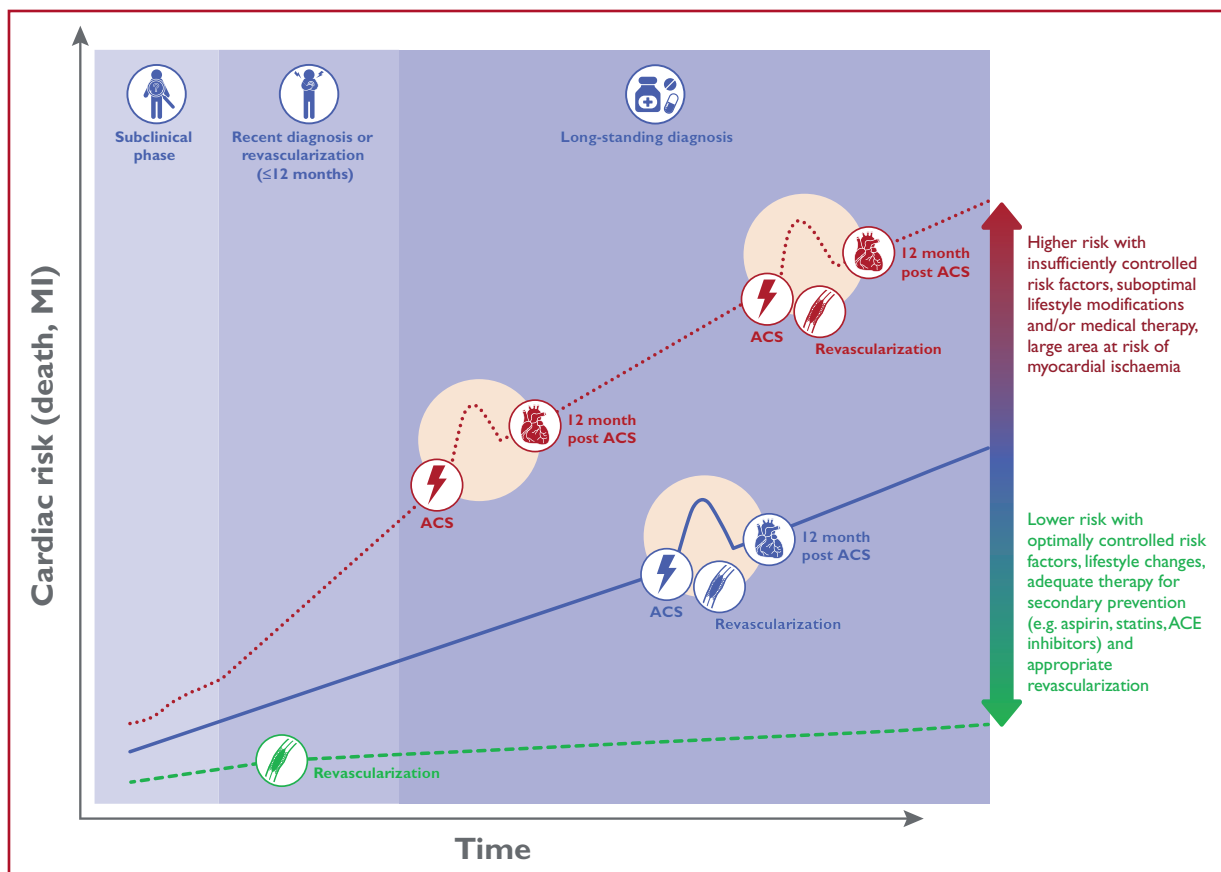

Figure 1 Schematic illustration of the natural history of chronic coronary syndromes. ACE = angiotensin-converting enzyme; ACS = acute coronary syndromes; CCS = chronic coronary syndromes; MI = myocardial infarction.

categorized as either acute coronary syndromes (ACS) or chronic coronary syndromes (CCS). The Guidelines presented here refer to the management of patients with CCS. The natural history of CCS is illustrated in *Figure 1*.

The most frequently encountered clinical scenarios in patients with suspected or established CCS are: (i) patients with suspected CAD and 'stable' anginal symptoms, and/or dyspnoea (see *section 3*); (ii) patients with new onset of heart failure (HF) or left ventricular (LV) dysfunction and suspected CAD (see *section 4*); (iii) asymptomatic and symptomatic patients with stabilized symptoms <1 year after an ACS, or patients with recent revascularization (see *section 5.1*); (iv) asymptomatic and symptomatic patients >1 year after initial diagnosis or revascularization (see *section 5.2*); (v) patients with angina and suspected vasospastic or microvascular disease (see *section 6*); and (vi) asymptomatic subjects in whom CAD is detected at screening (see *section 7*).

All of these scenarios are classified as a CCS but involve different risks for future cardiovascular events [e.g. death or myocardial infarction

(MI)], and the risk may change over time. Development of an ACS may acutely destabilize each of these clinical scenarios. The risk may increase as a consequence of insufficiently controlled cardiovascular risk factors, suboptimal lifestyle modifications and/or medical therapy, or unsuccessful revascularization. Alternatively, the risk may decrease as a consequence of appropriate secondary prevention and successful revascularization. Hence, CCS are defined by the different evolutionary phases of CAD, excluding situations in which an acute coronary artery thrombosis dominates the clinical presentation (i.e. ACS).

In the present Guidelines, each section deals with the main clinical scenarios of CCS. This structure aims to simplify the use of the Guidelines in clinical practice. Additional information, tables, figures, and references are available in the [Supplementary Data](#) on the ESC website (www.escardio.org) as well as in *The ESC Textbook of Cardiovascular Medicine*.

2.1 What is new in the 2019 Guidelines?

New/revised concepts in 2019	
The Guidelines have been revised to focus on CCS instead of stable CAD.	
This change emphasizes the fact that the clinical presentations of CAD can be categorized as either ACS or CCS. CAD is a dynamic process of atherosclerotic plaque accumulation and functional alterations of coronary circulation that can be modified by lifestyle, pharmacological therapies, and revascularization, which result in disease stabilization or regression.	
In the current Guidelines on CCS, six clinical scenarios most frequently encountered in patients are identified: (i) patients with suspected CAD and 'stable' anginal symptoms, and/or dyspnoea; (ii) patients with new onset of HF or LV dysfunction and suspected CAD; (iii) asymptomatic and symptomatic patients with stabilized symptoms <1 year after an ACS or patients with recent revascularization; (iv) asymptomatic and symptomatic patients >1 year after initial diagnosis or revascularization; (v) patients with angina and suspected vasospastic or microvascular disease; (vi) asymptomatic subjects in whom CAD is detected at screening.	
The PTP of CAD based on age, gender and nature of symptoms have undergone major revisions. In addition, we introduced a new phrase 'Clinical likelihood of CAD' that utilizes also various risk factors of CAD as PTP modifiers. The application of various diagnostic tests in different patient groups to rule-in or rule-out CAD have been updated.	
The Guidelines emphasize the crucial role of healthy lifestyle behaviours and other preventive actions in decreasing the risk of subsequent cardiovascular events and mortality.	

ACS = acute coronary syndromes; CAD = coronary artery disease; CCS = chronic coronary syndromes; HF = heart failure; LV = left ventricular; PTP = pre-test probability.

New major recommendations in 2019	
Basic testing, diagnostics, and risk assessment	
Non-invasive functional imaging for myocardial ischaemia or coronary CTA is recommended as the initial test for diagnosing CAD in symptomatic patients in whom obstructive CAD cannot be excluded by clinical assessment alone.	I
It is recommended that selection of the initial non-invasive diagnostic test be based on the clinical likelihood of CAD and other patient characteristics that influence test performance, local expertise, and the availability of tests.	I
Functional imaging for myocardial ischaemia is recommended if coronary CTA has shown CAD of uncertain functional significance or is not diagnostic.	I
Invasive angiography is recommended as an alternative test to diagnose CAD in patients with a high clinical likelihood and severe symptoms refractory to medical therapy, or typical angina at a low level of exercise and clinical evaluation that indicates high event risk. Invasive functional assessment must be available and used to evaluate stenoses before revascularization, unless very high grade (>90% diameter stenosis).	I
Invasive coronary angiography with the availability of invasive functional evaluation should be considered for confirmation of the diagnosis of CAD in patients with an uncertain diagnosis on non-invasive testing.	IIa
Coronary CTA should be considered as an alternative to invasive angiography if another non-invasive test is equivocal or non-diagnostic.	IIa
Coronary CTA is not recommended when extensive coronary calcification, irregular heart rate, significant obesity, inability to cooperate with breath-hold commands, or any other conditions make good image quality unlikely.	III

Continued

Antithrombotic therapy in patients with CCS and sinus rhythm	
Addition of a second antithrombotic drug to aspirin for long-term secondary prevention should be considered in patients with a high risk of ischaemic events and without high bleeding risk (see options in section 3.3.2).	IIa
Addition of a second antithrombotic drug to aspirin for long-term secondary prevention may be considered in patients with at least a moderately increased risk of ischaemic events and without high bleeding risk (see options in section 3.3.2).	IIb
Antithrombotic therapy in patients with CCS and AF	
When oral anticoagulation is initiated in a patient with AF who is eligible for a NOAC, a NOAC is recommended in preference to a VKA.	I
Long-term OAC therapy (a NOAC or VKA with time in therapeutic range >70%) is recommended in patients with AF and a CHA ₂ DS ₂ -VASc score ≥2 in males and ≥3 in females.	I
Long-term OAC therapy (a NOAC or VKA with time in therapeutic range >70%) should be considered in patients with AF and a CHA ₂ DS ₂ -VASc score of 1 in males and 2 in females.	IIa
Antithrombotic therapy in post-PCI patients with AF or another indication for OAC	
In patients who are eligible for a NOAC, it is recommended that a NOAC (apixaban 5 mg b.i.d., dabigatran 150 mg b.i.d., edoxaban 60 mg o.d., or rivaroxaban 20 mg o.d.) is used in preference to a VKA in combination with antiplatelet therapy.	I
When rivaroxaban is used and concerns about high bleeding risk prevail over concerns about stent thrombosis or ischaemic stroke, rivaroxaban 15 mg o.d. should be considered in preference to rivaroxaban 20 mg o.d. for the duration of concomitant single or dual antiplatelet therapy.	IIa
When dabigatran is used and concerns about high bleeding risk prevail over concerns about stent thrombosis or ischaemic stroke, dabigatran 110 mg b.i.d. should be considered in preference to dabigatran 150 mg b.i.d. for the duration of concomitant single or dual antiplatelet therapy.	IIa
After uncomplicated PCI, early cessation (≤1 week) of aspirin, and continuation of dual therapy with OAC and clopidogrel, should be considered if the risk of stent thrombosis is low or if concerns about bleeding risk prevail over concerns about risk of stent thrombosis, irrespective of the type of stent used.	IIa
Triple therapy with aspirin, clopidogrel, and an OAC for ≥1 month should be considered when the risk of stent thrombosis outweighs the bleeding risk, with the total duration (≤6 months) decided upon according to the assessment of these risks and clearly specified at hospital discharge.	IIa
In patients with an indication for a VKA in combination with aspirin and/or clopidogrel, the dose intensity of the VKA should be carefully regulated with a target international normalized ratio in the range of 2.0–2.5 and with time in therapeutic range >70%.	IIa
Dual therapy with an OAC and either ticagrelor or prasugrel may be considered as an alternative to triple therapy with an OAC, aspirin, and clopidogrel in patients with a moderate or high risk of stent thrombosis, irrespective of the type of stent used.	IIb
Other pharmacological therapy	
Concomitant use of a proton pump inhibitor is recommended in patients receiving aspirin monotherapy, DAPT, or OAC monotherapy who are at high risk of gastrointestinal bleeding.	I
Lipid-lowering drugs: if goals are not achieved with the maximum tolerated dose of statin, combination with ezetimibe is recommended.	I
Lipid-lowering drugs: for patients at very high risk who do not achieve their goals on a maximum tolerated dose of statin and ezetimibe, combination with a PCSK9 inhibitor is recommended.	I
ACE inhibitors should be considered in CCS patients at very high risk of cardiovascular adverse events.	IIa
The sodium-glucose co-transporter 2 inhibitors empagliflozin, canagliflozin, or dapagliflozin are recommended in patients with diabetes mellitus and CVD.	I
A glucagon-like peptide-1 receptor agonist (liraglutide or semaglutide) is recommended in patients with diabetes mellitus and CVD.	I
Screening for CAD in asymptomatic subjects	
Carotid ultrasound IMT for cardiovascular risk assessment is not recommended.	III
Recommendations for treatment options for refractory angina	
A reducer device for coronary sinus constriction may be considered to ameliorate symptoms of debilitating angina refractory to optimal medical and revascularization strategies.	IIb

^aClass of recommendation.

ACE = angiotensin-converting enzyme; ACS = acute coronary syndromes; AF = atrial fibrillation; b.i.d. = bis in die (twice a day); CAD = coronary artery disease; CCS = chronic coronary syndromes; CHA₂DS₂-VASc = Cardiac failure, Hypertension, Age ≥75 [Doubled], Diabetes, Stroke [Doubled] – Vascular disease, Age 65–74 and Sex category [Female]; CTA = computed tomography angiography; CVD = cardiovascular disease; HF = heart failure; IMT = intima-media thickness; LV = left ventricular; NOAC = non-vitamin K antagonist oral anticoagulant; OAC = oral anticoagulant; o.d. = omni die (once a day); PCI = percutaneous coronary intervention; PCSK9 = proprotein convertase subtilisin-kexin type 9; VKA = vitamin K antagonist.

Changes in major recommendations			
2013	Class ^a	2019	Class ^a
Exercise ECG is recommended as the initial test to establish a diagnosis of stable CAD in patients with symptoms of angina and intermediate PTP of CAD (15–65%), free of anti-ischaemic drugs, unless they cannot exercise or display ECG changes that make the ECG non-evaluable.	I	Exercise ECG is recommended for the assessment of exercise tolerance, symptoms, arrhythmias, BP response, and event risk in selected patients.	I
		Exercise ECG may be considered as an alternative test to rule-in or rule-out CAD when other non-invasive or invasive imaging methods are not available.	IIb
Exercise ECG should be considered in patients on treatment to evaluate control of symptoms and ischaemia.	IIa	Exercise ECG may be considered in patients on treatment to evaluate control of symptoms and ischaemia.	IIb
For second-line treatment it is recommended that long-acting nitrates, ivabradine, nicorandil, or ranolazine are added according to heart rate, BP, and tolerance.	IIa	Long-acting nitrates should be considered as a second-line treatment option when initial therapy with a beta-blocker and/or a non-DHP-CCB is contraindicated, poorly tolerated, or inadequate in controlling angina symptoms.	IIa
For second-line treatment, trimetazidine may be considered,	IIb	Nicorandil, ranolazine, ivabradine, or trimetazidine should be considered as a second-line treatment to reduce angina frequency and improve exercise tolerance in subjects who cannot tolerate, have contraindications to, or whose symptoms are not adequately controlled by beta-blockers, CCBs, and long-acting nitrates.	IIa
		In selected patients, the combination of a beta-blocker or a CCB with second-line drugs (ranolazine, nicorandil, ivabradine, and trimetazidine) may be considered for first-line treatment according to heart rate, BP, and tolerance.	IIb
In patients with suspected coronary microvascular angina: intracoronary acetylcholine and adenosine with Doppler measurements may be considered during coronary arteriography, if the arteriogram is visually normal, to assess endothelium-dependent and non-endothelium-dependent CFR, and detect microvascular/epicardial vasospasm.	IIb	Guidewire-based CFR and/or microcirculatory resistance measurements should be considered in patients with persistent symptoms, but coronary arteries that are either angiographically normal or have moderate stenoses with preserved iwFR/FFR.	IIa
		Intracoronary acetylcholine with ECG monitoring may be considered during angiography, if coronary arteries are either angiographically normal or have moderate stenoses with preserved iwFR/FFR, to assess microvascular vasospasm.	IIb
In patients with suspected coronary microvascular angina: transthoracic Doppler echocardiography of the LAD, with measurement of diastolic coronary blood flow following intravenous adenosine and at rest, may be considered for non-invasive measurement of CFR.	IIb	Transthoracic Doppler of the LAD, CMR, and PET may be considered for non-invasive assessment of CFR.	IIb

^aClass of recommendation.

BP = blood pressure; CAD = coronary artery disease; CCB = calcium channel blocker; CFR = coronary flow reserve; CMR = cardiac magnetic resonance; DHP-CCB = dihydropyridine calcium channel blockers; ECG = electrocardiogram; FFR = fractional flow reserve; iwFR = instantaneous wave-free ratio (instant flow reserve); LAD = left anterior descending; PET = positron emission tomography; PTP = pre-test probability.

3 Patients with angina and/or dyspnoea, and suspected coronary artery disease

3.1 Basic assessment, diagnosis, and risk assessment

The general approach for the initial diagnostic management of patients with angina and suspected obstructive CAD is presented in *Figure 2*. The diagnostic management approach includes six steps. The first step is to assess the symptoms and signs, to identify patients with possible unstable angina or other forms of

ACS (step 1). In patients without unstable angina or other ACS, the next step is to evaluate the patient's general condition and quality of life (step 2). Comorbidities that could potentially influence therapeutic decisions are assessed and other potential causes of the symptoms are considered. Step 3 includes basic testing and assessment of LV function. Thereafter, the clinical likelihood of obstructive CAD is estimated (step 4) and, on this basis, diagnostic testing is offered to selected patients to establish the diagnosis of CAD (step 5). Once a diagnosis of obstructive CAD has been confirmed, the patient's event risk will be determined (step 6) as it has a major impact on the subsequent therapeutic decisions.

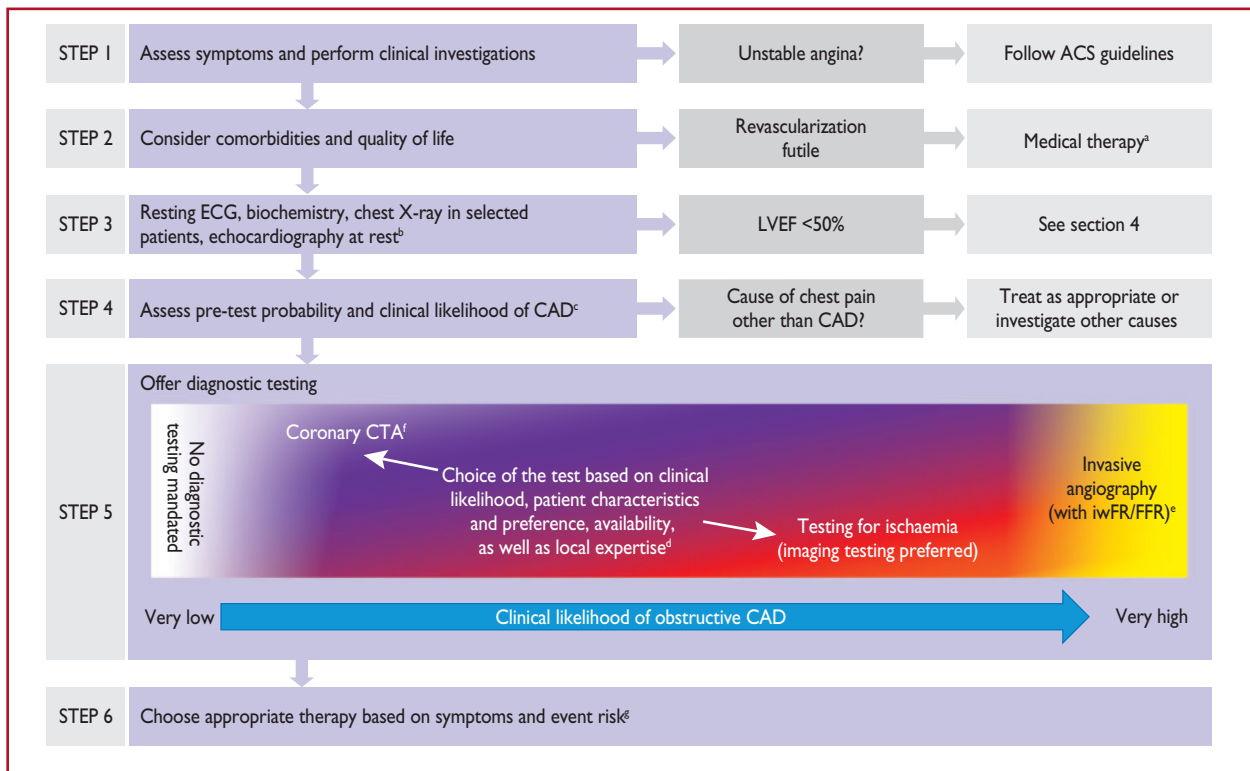

©ESC 2019

Figure 2 Approach for the initial diagnostic management of patients with angina and suspected coronary artery disease. ACS = acute coronary syndrome; BP = blood pressure; CAD = coronary artery disease; CTA = computed tomography angiography; ECG = electrocardiogram; FFR = fractional flow reserve; iwFR = instantaneous wave-free ratio; LVEF = left ventricular ejection fraction. ^aIf the diagnosis of CAD is uncertain, establishing a diagnosis using non-invasive functional imaging for myocardial ischaemia before treatment may be reasonable. ^bMay be omitted in very young and healthy patients with a high suspicion of an extracardiac cause of chest pain, and in multimorbid patients in whom the echocardiography result has no consequence for further patient management. ^cConsider exercise ECG to assess symptoms, arrhythmias, exercise tolerance, BP response, and event risk in selected patients. ^dAbility to exercise, individual test-related risks, and likelihood of obtaining diagnostic test result. ^eHigh clinical likelihood and symptoms inadequately responding to medical treatment, high event risk based on clinical evaluation (such as ST-segment depression, combined with symptoms at a low workload or systolic dysfunction indicating CAD), or uncertain diagnosis on non-invasive testing. ^fFunctional imaging for myocardial ischaemia if coronary CTA has shown CAD of uncertain grade or is non-diagnostic. ^gConsider also angina without obstructive disease in the epicardial coronary arteries (see section 6).

After these steps, appropriate therapies are to be initiated, which include lifestyle management (see section 3.2), medical therapy (see section 3.3), and revascularization when indicated (see section 3.4).

3.1.1. Step 1: Symptoms and signs

A careful history is the cornerstone of the diagnosis of angina. It is possible to achieve a high degree of certainty on a diagnosis based on history alone, although physical examination and objective tests are most often necessary to confirm the diagnosis, exclude alternative diagnoses, and assess the severity of underlying disease. The history should include any manifestation of cardiovascular disease (CVD) and risk factors (i.e. family history of CVD, dyslipidaemia, diabetes, hypertension, smoking, and other lifestyle factors).

The characteristics of discomfort related to myocardial ischaemia (angina pectoris) may be divided into four categories: location, character, duration, and relationship to exertion, and other

exacerbating or relieving factors. The discomfort caused by myocardial ischaemia is usually located in the chest, near the sternum, but may be felt anywhere from the epigastrium to the lower jaw or teeth, between the shoulder blades, or in either arm to the wrist and fingers. The discomfort is often described as pressure, tightness, or heaviness; sometimes strangling, constricting, or burning. It may be useful to ask the patient directly about the presence of 'discomfort' as many do not feel 'pain' or 'pressure' in their chest. Shortness of breath may accompany angina, and chest discomfort may also be accompanied by less-specific symptoms such as fatigue or faintness, nausea, burning, restlessness, or a sense of impending doom. Shortness of breath may be the sole symptom of CAD and it may be difficult to differentiate this from shortness of breath caused by other conditions.

The duration of the discomfort is brief—≤10 min in the majority of cases, and more commonly just a few minutes or less—and chest pain lasting for seconds is unlikely to be due to CAD. An important characteristic is the relationship to exercise. Symptoms

classically appear or become more severe with increased levels of exertion—such as walking up an incline or against a breeze, or in cold weather—and rapidly disappear within a few minutes when these causal factors abate. Exacerbations of symptoms after a heavy meal or after waking up in the morning are classic features of angina. Angina may paradoxically be reduced with further exercise (walk-through angina) or on second exertion (warm-up angina).¹ Sublingual nitrates rapidly relieve angina. Symptoms are unrelated to respiration or position. The angina threshold, and hence symptoms, may vary considerably from day to day and even during the same day.

Definitions of typical and atypical angina are summarized in Table 3. The classification, although subjective, is practical and of proven value in determining the likelihood of obstructive CAD.^{2,3} Studies published since 2015 have reported that the majority of patients suspected of having CAD present with atypical or non-anginal chest pain,^{4–6} with as few as 10–15% presenting with typical angina.^{3,7,8} The Canadian Cardiovascular Society classification is still widely used as a grading system for angina,⁹ to quantify the threshold at which symptoms occur in relation to physical activities (Table 4).

Physical examination of a patient with suspected CAD is important to assess the presence of anaemia, hypertension, valvular heart disease, hypertrophic cardiomyopathy, or arrhythmias. It is also recom-

mended that practitioners obtain the body mass index (BMI) and search for evidence of non-coronary vascular disease, which may be asymptomatic [includes palpation of peripheral pulses, and auscultation of carotid and femoral arteries, as well as assessment of the ankle-brachial index (ABI)], and other signs of comorbid conditions such as thyroid disease, renal disease, or diabetes. This should be used in the context of other clinical information, such as the presence of cough or stinging pain, making CAD more unlikely. One should also try to reproduce the symptoms by palpation¹⁰ and test the effect of sublingual nitroglycerin in order to classify the symptoms (Table 3).

3.1.1.1 Stable vs. unstable angina

Unstable angina may present in one of three ways: (i) as rest angina, i.e. pain of characteristic nature and location occurring at rest and for prolonged periods (>20 min); (ii) new-onset angina, i.e. recent (2 months) onset of moderate-to-severe angina (Canadian Cardiovascular Society grade II or III); or (iii) crescendo angina, i.e. previous angina, which progressively increases in severity and intensity, and at a lower threshold, over a short period of time. Management of angina fulfilling these criteria is dealt with in the ESC Guidelines for the management of ACS.^{11,12} New-onset angina is generally regarded as unstable angina; however, if angina occurs for the first time with heavy exertion and subsides at rest, the suspected condition falls under the definition of CCS rather than unstable angina. In patients with unstable angina identified as being at low risk, it is recommended that the diagnostic and prognostic algorithms presented in these Guidelines be applied once the period of instability has subsided.¹¹ Low-risk patients with unstable angina are characterized by no recurrence of angina, no signs of HF, no abnormalities in the initial or subsequent electrocardiogram (ECG), and no rise in troponin levels.¹¹ In this setting, a non-invasive diagnostic strategy is recommended before deciding on an invasive strategy. Based on the definition above, stable and unstable angina may overlap, and many CCS patients pass through a period of experiencing unstable angina.

Table 3 Traditional clinical classification of suspected anginal symptoms

Typical angina	Meets the following three characteristics: (i) Constricting discomfort in the front of the chest or in the neck, jaw, shoulder, or arm; (ii) Precipitated by physical exertion; (iii) Relieved by rest or nitrates within 5 min.
Atypical angina	Meets two of these characteristics.
Non-anginal chest pain	Meets only one or none of these characteristics.

©ESC 2019

Table 4 Grading of effort angina severity according to the Canadian Cardiovascular Society

Grade	Description of angina severity	
I	Angina only with strenuous exertion	Presence of angina during strenuous, rapid, or prolonged ordinary activity (walking or climbing the stairs).
II	Angina with moderate exertion	Slight limitation of ordinary activities when they are performed rapidly, after meals, in cold, in wind, under emotional stress, or during the first few hours after waking up, but also walking uphill, climbing more than one flight of ordinary stairs at a normal pace, and in normal conditions.
III	Angina with mild exertion	Having difficulties walking one or two blocks, or climbing one flight of stairs, at normal pace and conditions.
IV	Angina at rest	No exertion needed to trigger angina.

©ESC 2019

3.1.1.2 Distinction between symptoms caused by epicardial vs. microvascular/vasospastic disease

A distinction between symptoms caused by an epicardial stenosis and symptoms caused by microvascular or vasospastic disease cannot be made with reasonable certainty. Reliance on ischaemia testing or depiction of the coronary anatomy is often unavoidable to exclude obstructive CAD, which can be absent in symptomatic patients.^{13,14} A diagnostic workup for microvascular or vasospastic disease is discussed in section 6 of these Guidelines.

3.1.2 Step 2: Comorbidities and other causes of symptoms

Before any testing is considered, one must assess the patient’s general health, comorbidities, and quality of life. If revascularization is unlikely to be an acceptable option, further testing may be reduced to a clinically indicated minimum and appropriate therapy should be instituted, which may include a trial of antianginal medication even if a diagnosis of CAD has not been fully demonstrated. Non-invasive functional imaging for ischaemia may be an option if there is need to verify the diagnosis (Figure 2).

If the pain is clearly non-anginal, other diagnostic testing may be indicated to identify gastrointestinal, pulmonary, or musculoskeletal causes of chest pain. Nevertheless, these patients should also receive Guideline-based risk-factor modification based on commonly applied risk charts such as SCORE (Systematic COronary Risk Evaluation) (www.heartscore.org).¹⁵

3.1.3 Step 3: Basic testing

Basic (first-line) testing in patients with suspected CAD includes standard laboratory biochemical testing, a resting ECG, possible ambulatory ECG monitoring, resting echocardiography, and, in selected patients, a chest X-ray. Such testing can be done on an outpatient basis.

3.1.3.1 Biochemical tests

Laboratory investigations are used to identify possible causes of ischaemia, to establish cardiovascular risk factors and associated

conditions, and to determine prognosis. Haemoglobin as part of a full blood count and—where there is a clinical suspicion of a thyroid disorder—thyroid hormone levels provide information related to possible causes of ischaemia. Fasting plasma glucose and glycated haemoglobin (HbA1c) should be measured in every patient with suspected CAD. If both are inconclusive, an additional oral glucose tolerance test is recommended.¹⁶ Knowledge of glucose metabolism is important because of the well-recognized association between diabetes and adverse cardiovascular outcome. Patients with diabetes should be managed according to specific Guidelines.^{15,16} A lipid profile, including total cholesterol, high-density lipoprotein cholesterol, low-density lipoprotein cholesterol (LDL-C), and triglycerides, should also be evaluated in any patient with suspected CAD to establish the patient’s risk profile and ascertain the need for treatment.^{15,17} To characterize severe dyslipidaemia or follow-up on high triglyceridaemia, fasting values are recommended.¹⁷

Peripheral artery disease (PAD) and renal dysfunction increase the likelihood of CAD, and have a negative impact on prognosis.^{18–20} Hence, baseline renal function should be evaluated with estimation of the glomerular filtration rate (GFR). It may also be reasonable to measure the uric acid level, as hyperuricaemia is a frequent comorbid condition and may also affect renal function.

If there is a clinical suspicion of CAD instability, biochemical markers of myocardial injury—such as troponin T or troponin I—should be measured, preferably using high-sensitivity assays, and management should follow the Guidelines for ACS without persistent ST-segment elevation.¹¹ If high-sensitivity assays are employed, low levels of troponin can be detected in many patients with stable angina. Increased troponin levels are associated with adverse outcome^{21–25} and small studies have indicated a possible incremental value in diagnosing CAD,^{26,27} but larger trials are needed to verify the utility of systematic assessment in patients suspected of CAD. While multiple biomarkers may be useful for prognostication (see section 5), they do not yet have a role in diagnosing obstructive CAD.

Basic biochemistry testing in the initial diagnostic management of patients with suspected coronary artery disease

Recommendations	Class ^a	Level ^b
If evaluation suggests clinical instability or ACS, repeated measurements of troponin, preferably using high-sensitivity or ultrasensitive assays, are recommended to rule-out myocardial injury associated with ACS. ^{28,29}	I	A
The following blood tests are recommended in all patients:		
• Full blood count (including haemoglobin); ³⁰	I	B
• Creatinine measurement and estimation of renal function; ^{31,32}	I	A
• A lipid profile (including LDL-C). ^{33,34}	I	A
It is recommended that screening for type 2 diabetes mellitus in patients with suspected and established CCS is implemented with HbA1c and fasting plasma glucose measurements, and that an oral glucose tolerance test is added if HbA1c and fasting plasma glucose results are inconclusive. ^{16,35}	I	B
Assessment of thyroid function is recommended in case of clinical suspicion of thyroid disorders.	I	C

ACS = acute coronary syndromes; CAD = coronary artery disease; CCS = chronic coronary syndromes; HbA1c = glycated haemoglobin; LDL-C = low-density lipoprotein cholesterol.

^aClass of recommendation.

^bLevel of evidence.

3.1.3.2 Resting electrocardiogram and ambulatory monitoring

The paradigm of diagnosing myocardial ischaemia has, for almost a century, been based on the detection of repolarization abnormalities, mainly in the form of ST-segment depressions. Thus, the resting 12 lead ECG remains an indispensable component of the initial evaluation of a patient with chest pain without an obviously non-cardiac cause. Two scenarios of clinical evaluation are encountered: (i) a patient without symptoms of chest pain or discomfort, and (ii) a patient with ongoing anginal symptoms.

The former situation is far more prevalent and a normal resting ECG is frequently recorded. However, even in the absence of repolarization abnormalities, an ECG can demonstrate indirect signs of CAD, such as signs of previous MI (pathological Q waves) or conduction abnormalities [mainly left bundle branch block (LBBB) and impairment of atrioventricular conduction]. Atrial fibrillation (AF) is a frequent finding in patients with chest pain (usually atypical). ST-segment depression during supraventricular tachyarrhythmias is not predictive of obstructive CAD.^{36–39}

The ECG can be crucial for diagnosing myocardial ischaemia if dynamic ST-segment changes are recorded during ongoing angina. The diagnosis of Prinzmetal and vasospastic angina is based on the detection of typical transient ST-segment elevation or depression during an angina attack (usually at rest).

Long-term ambulatory ECG monitoring and recording should not be used to replace exercise testing; however, 12 lead ECG monitoring can be considered in selected patients to detect anginal episodes unrelated to physical exercise. Ambulatory ECG monitoring may reveal evidence of silent myocardial ischaemia in patients with CCS, but rarely adds relevant diagnostic or prognostic information that cannot be derived from stress testing.⁴⁰ ECG changes suggesting ischaemia on ambulatory ECG monitoring are very frequent in women, but do not correlate with findings during stress testing.⁴¹ Most importantly, therapeutic strategies targeting silent ischaemia detected by ambulatory monitoring have not demonstrated clear survival benefits.^{42,43}

Resting electrocardiogram in the initial diagnostic management of patients with suspected coronary artery disease

Recommendations	Class ^a	Level ^b
A resting 12 lead ECG is recommended in all patients with chest pain without an obvious non-cardiac cause.	I	C
A resting 12 lead ECG is recommended in all patients during or immediately after an episode of angina suspected to be indicative of clinical instability of CAD.	I	C
ST-segment alterations recorded during supraventricular tachyarrhythmias should not be used as evidence of CAD.	III	C

CAD = coronary artery disease; CCS = chronic coronary syndromes; ECG = electrocardiogram.

^aClass of recommendation.

^bLevel of evidence.

Ambulatory electrocardiogram monitoring in the initial diagnostic management of patients with suspected coronary artery disease

Recommendations	Class ^a	Level ^b
Ambulatory ECG monitoring is recommended in patients with chest pain and suspected arrhythmias.	I	C
Ambulatory ECG recording, preferably monitoring with 12 lead ECG, should be considered in patients with suspected vasospastic angina.	IIa	C
Ambulatory ECG monitoring should not be used as a routine examination in patients with suspected CCS.	III	C

CAD = coronary artery disease; CCS = chronic coronary syndromes; ECG = electrocardiogram.

^aClass of recommendation.

^bLevel of evidence.

3.1.3.3 Echocardiography and magnetic resonance imaging at rest

An echocardiographic study will provide important information about cardiac function and anatomy. LV ejection fraction (LVEF) is often normal in patients with CCS.⁴⁴ A decreased LV function and/or regional wall motion abnormalities may increase the suspicion of ischaemic myocardial damage,⁴⁵ and a pattern of LV dysfunction following the theoretical distribution territory of the coronary arteries is typical in patients who have already had an MI.^{46,47} The detection of regional wall motion abnormalities can be challenging by visual assessment, and detection of early systolic lengthening, decreased systolic shortening, or post-systolic shortening by strain imaging techniques might be helpful in patients with apparently normal LV function but with clinical suspicion of CCS.^{48–50} Decreased diastolic LV function has been reported to be an early sign of ischaemic myocardial dysfunction and could also be indicative of microvascular dysfunction.^{51,52}

Echocardiography is an important clinical tool for the exclusion of alternative causes of chest pain and also aids in diagnosing concurrent cardiac diseases, such as valvular heart diseases, HF, and most cardiomyopathies,⁵³ but it is important to remember that these diseases often coexist with obstructive CAD. The use of an echocardiographic contrast agent can be useful in patients with poor acoustic windows.⁵⁴

Cardiac magnetic resonance (CMR) may be considered in patients with suspected CAD when the echocardiogram (having used contrast) is inconclusive.⁵⁵ CMR will provide useful information on cardiac anatomy and systolic cardiac function, similar to that from an echocardiogram, in patients with no contraindications for CMR. CMR can assess global and regional function,⁵⁶ and the use of late gadolinium enhancement CMR can reveal a typical pattern of scarred myocardium in patients who have already experienced an MI.⁵⁷

Assessment of LV function is important in all patients for risk stratification (see [Supplementary Data section 3.2](#)) and should therefore be performed in all symptomatic patients with suspected CAD.

Management of patients with either angina or HF symptoms, with reduced LVEF <40% or a mid-range reduced LVEF of 40-49%, is described in section 4 of the Guidelines.

Resting echocardiography and cardiac magnetic resonance in the initial diagnostic management of patients with suspected coronary artery disease

Recommendations	Class ^a	Level ^b
A resting transthoracic echocardiogram is recommended in all patients for: (1) Exclusion of alternative causes of angina; (2) Identification of regional wall motion abnormalities suggestive of CAD; (3) Measurement of LVEF for risk stratification; and (4) Evaluation of diastolic function. ^{44,45,52,58}	I	B
Ultrasound of the carotid arteries should be considered, and be performed by adequately trained clinicians, to detect plaque in patients with suspected CCS without known atherosclerotic disease.	IIa	C
CMR may be considered in patients with an inconclusive echocardiographic test.	IIb	C

© ESC 2019

CAD = coronary artery disease; CCS = chronic coronary syndromes; CMR = cardiac magnetic resonance imaging; LVEF = left ventricular ejection fraction.
^aClass of recommendation.
^bLevel of evidence.

3.1.3.4 Chest X-ray

Chest X-ray is frequently used in the assessment of patients with chest pain. However, in CCS, it does not provide specific information for diagnosis or event risk stratification. The test may occasionally be helpful in assessing patients with suspected HF. Chest X-ray may also be useful in patients with pulmonary problems, which often accompany CAD, or to rule-out another cause of chest pain in atypical presentations.

Chest X-ray in the initial diagnostic management of patients with suspected coronary artery disease

Recommendation	Class ^a	Level ^b
Chest X-ray is recommended for patients with atypical presentation, signs and symptoms of HF, or suspicion of pulmonary disease.	I	C

© ESC 2019

HF = heart failure.
^aClass of recommendation.
^bLevel of evidence.

3.1.4 Step 4: Assessment of pre-test probability and clinical likelihood of coronary artery disease

The performance of the available methods in diagnosing obstructive CAD (i.e. the likelihood that the patient has disease if the test is abnormal, and the likelihood that the patient does not have disease if the test is normal) depends on the prevalence of disease in the

population studied and, thus, the likelihood that a given patient will actually have CAD. Diagnostic testing is most useful when the likelihood is intermediate. When likelihood is high, a large number of patients need to be studied to identify the few patients that do not have disease, and a negative test result can seldom rule out the presence of obstructive CAD (i.e. the negative predictive value is low). When the likelihood is low, a negative test can rule out the disease, but the lower the likelihood, the higher the likelihood of a false-positive test (i.e. a positive test in the absence of obstructive CAD). In patients at the extreme ends of the probability range, it is therefore reasonable to refrain from diagnostic testing, and assume that the patient does or does not have obstructive CAD based on clinical evaluation alone.

The likelihood of obstructive CAD is influenced by the prevalence of the disease in the population studied, as well as by clinical features of an individual patient. A simple predictive model can be used to estimate the pre-test probability (PTP) of obstructive CAD based on age, sex, and the nature of symptoms.⁵⁹ In the previous version of these Guidelines,⁶⁰ estimation of the PTP was based on data gathered by Genders *et al.*,⁶¹ which updated previous data from Diamond and Forrester.⁵⁹ Notably, the prevalence of disease for a given constellation of age, sex, and nature of symptoms was lower than in the Diamond and Forrester data. Since the previous version of the Guidelines was published, several studies have indicated that the prevalence of obstructive disease among patients with suspected CAD is lower than in the previous update.^{7,8,62,63}

A pooled analysis⁶⁴ of three contemporary study cohorts, including patients evaluated for suspected CAD,^{7,8,62} has indicated that the PTP based on age, sex, and symptoms is approximately one-third of that predicted by the model used in the previous version of the Guidelines.^{57,62} Overestimation of PTP is an important contributory factor to a low diagnostic yield of non-invasive and invasive testing. The new set of PTPs presented in Table 5 may substantially reduce the need for non-invasive and invasive tests in patients with suspected stable CAD. The table now also includes patients presenting with dyspnoea as their main symptom. However, it should be noted that the PTPs presented in Table 5 (as well as the PTP table in the previous version of the Guidelines) are based mainly on patients from countries with low CVD risk, and may vary between regions and countries.

Application of the new PTPs (Table 5) has important consequences for the referral of patients for diagnostic testing. If diagnostic testing was deferred in patients with a new PTP <15%, this would result in a large increase in the proportion of patients for whom diagnostic testing was not recommended, because more patients are classified as having a PTP <15%. In data derived from the PROMISE (Prospective Multicenter Imaging Study for Evaluation of Chest Pain) trial, 50% of patients previously classified as having an intermediate likelihood of obstructive CAD were reclassified to a PTP <15% according to the new PTP.⁶² In data derived from the pooled analysis⁶⁴ (Table 5), 57% of all patients were classified to a PTP <15%.

Studies have shown that outcomes in patients classified with the new PTP <15% is good (annual risk of cardiovascular death or MI is <1%).^{7,62} Hence, it is safe to defer routine testing in patients with PTP <15%, thus reducing unnecessary procedures and costs.

Table 5 Pre-test probabilities of obstructive coronary artery disease in 15 815 symptomatic patients according to age, sex, and the nature of symptoms in a pooled analysis⁶⁴ of contemporary data^{7,8,62}

Age	Typical		Atypical		Non-anginal		Dyspnoea ^a	
	Men	Women	Men	Women	Men	Women	Men	Women
30–39	3%	5%	4%	3%	1%	1%	0%	3%
40–49	22%	10%	10%	6%	3%	2%	12%	3%
50–59	32%	13%	17%	6%	11%	3%	20%	9%
60–69	44%	16%	26%	11%	22%	6%	27%	14%
70+	52%	27%	34%	19%	24%	10%	32%	12%

©ESC 2019

CAD = coronary artery disease; PTP = pre-test probability.

^aIn addition to the classic Diamond and Forrester classes,⁵⁹ patients with dyspnoea only or dyspnoea as the primary symptom are included. The regions shaded dark green denote the groups in which non-invasive testing is most beneficial (PTP >15%). The regions shaded light green denote the groups with PTPs of CAD between 5–15%, in which testing for diagnosis may be considered after assessing the overall clinical likelihood based on the modifiers of PTPs presented in Figure 3.

Recent studies have also demonstrated that, when tested, the true observed prevalence of obstructive CAD has been <5% in patients who had a PTP <15% according to the 2013 version of these Guidelines.^{7,63} Therefore, this Task Force recognizes that the performance of diagnostic testing in patients with a new PTP of 5–15% more closely reflects current clinical practice and may be considered, particularly if symptoms are limiting and require clarification.^{7,63} Patient preference, local resources and the availability of tests, clinical judgement, and appropriate patient information remain important when making a decision to proceed with non-invasive diagnostic testing for an individual patient when the PTP is 5–15%, and the higher likelihood of a false-positive test must be considered. Patients with a PTP ≤5% can be assumed to have such a low probability of disease that diagnostic testing should be performed only for compelling reasons. Implementation of the new PTPs also indicates that patients should not be routinely referred directly to invasive assessment unless clinical or other data indicate a high likelihood of obstructive CAD.

Clinical models that incorporate information on risk factors for CVD, resting ECG changes, or coronary calcification have improved the identification of patients with obstructive CAD compared with age, sex, and symptoms alone.^{3,7,60,65–68} Therefore, the presence of risk factors for CVD (such as family history of CVD, dyslipidaemia, diabetes, hypertension, smoking, and other lifestyle factors) that increase the probability of obstructive CAD can be used as modifiers of the PTP estimate. If available, Q-wave, ST-segment, or T-wave changes on the ECG, LV dysfunction suggestive of ischaemia, and findings on exercise ECG, as well as information on coronary calcium obtained by computed tomography (CT), can be used to improve estimations of the PTP of obstructive CAD.^{3,69} In particular, the absence of coronary calcium (Agatston score = 0) is associated with a low prevalence of obstructive CAD (<5%), and low risk of death or non-fatal MI (<1% annual risk).^{69,70} However, it should be noted that coronary calcium imaging does not exclude coronary stenosis caused by a non-calcified atherosclerotic lesion,⁷⁰ and the presence of coronary calcium is a weak predictor of obstructive CAD.⁶⁹ Although the

optimal use of these factors in improving PTP assessment has not yet been established, they should be considered in addition to the PTP based on sex, age, and the nature of symptoms to determine the overall clinical likelihood of obstructive CAD, as summarized in Figure 3. This is particularly important in refining the likelihood of CAD patients with a PTP of 5–15% based on age, sex, and the nature of symptoms.

3.1.5 Step 5: Selecting appropriate testing

In patients in whom revascularization is futile due to comorbidities and overall quality of life, the diagnosis of CAD can be made clinically and only medical therapy is required. If the diagnosis of CAD is uncertain, establishing a diagnosis using non-invasive functional imaging for myocardial ischaemia before treatment is reasonable (Figure 2).

In a patient with a high clinical likelihood of CAD, symptoms unresponsive to medical therapy or typical angina at a low level of exercise, and an initial clinical evaluation (including echocardiogram and, in selected patients, exercise ECG) that indicates a high event risk, proceeding directly to invasive coronary angiography (ICA) without further diagnostic testing is a reasonable option. Under such circumstances, the indication for revascularization should be based on appropriate invasive confirmation of the haemodynamic significance of a stenosis.^{71,72}

In other patients in whom CAD cannot be excluded by clinical assessment alone, non-invasive diagnostic tests are recommended to establish the diagnosis and assess the event risk. The current Guidelines recommend the use of either non-invasive functional imaging of ischaemia or anatomical imaging using coronary CT angiography (CTA) as the initial test for diagnosing CAD.

3.1.5.1 Functional non-invasive tests

Functional non-invasive tests for the diagnosis of obstructive CAD are designed to detect myocardial ischaemia through ECG changes, wall motion abnormalities by stress CMR or stress echocardiography, or perfusion changes by single-photon emission CT

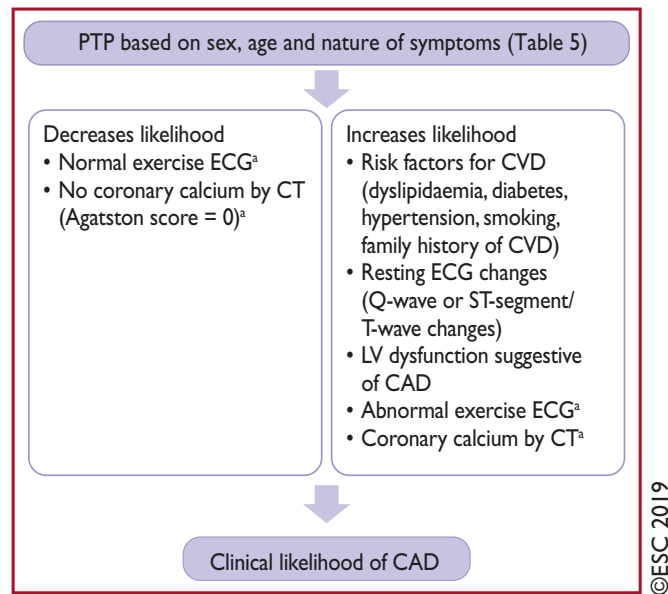

Figure 3 Determinants of the clinical likelihood of obstructive coronary artery disease. CAD = coronary artery disease; CT = computed tomography, CVD = cardiovascular disease, ECG = electrocardiogram, LV = left ventricular; PTP = pre-test probability. ^aWhen available.

(SPECT), positron emission tomography (PET), myocardial contrast echocardiography, or contrast CMR. Ischaemia can be provoked by exercise or pharmacological stressors, either by increased myocardial work and oxygen demand, or by heterogeneity in myocardial perfusion by vasodilatation. Non-invasive functional tests are associated with high accuracy for the detection of flow-limiting coronary stenosis compared with invasive functional testing [fractional flow reserve (FFR)].⁷³ However, lower-grade coronary atherosclerosis not linked with ischaemia remains undetected by functional testing and, in the presence of a negative functional test, patients should receive risk-factor modification based on commonly applied risk charts and recommendations.

3.1.5.2 Anatomical non-invasive evaluation

Anatomical non-invasive evaluation, by visualizing the coronary artery lumen and wall using an intravenous contrast agent, can be performed with coronary CTA, which provides high accuracy for the detection of obstructive coronary stenoses defined by ICA,⁷³ because both tests are based on anatomy. However, stenoses estimated to be 50–90% by visual inspection are not necessarily functionally significant, i.e. they do not always induce myocardial ischaemia.^{73,74} Therefore, either non-invasive or invasive functional testing is recommended for further evaluation of angiographic stenosis detected by coronary CTA or invasive angiography, unless a very high-grade (>90% diameter stenosis) stenosis is detected via invasive angiography. The presence or absence of non-obstructive coronary atherosclerosis on coronary CTA provides prognostic information, and can be used to guide preventive therapy.⁷⁵ The SCOT-HEART (Scottish Computed Tomography of the HEART) trial demonstrated a significantly lower rate of the combined endpoint of cardiovascular death or non-fatal MI (2.3 vs. 3.9% during 5 year follow-up) in patients in whom coronary CTA was performed in addition to routine testing, which consisted

predominantly of exercise ECG.⁶ Other randomized, prospective clinical trials have demonstrated that diagnostic testing with coronary CTA is associated with clinical outcomes similar to those for functional imaging in patients with suspected CAD.^{4,6,76} In patients with extensive CAD, coronary CTA complemented by CT-based FFR was non-inferior to ICA and FFR for decision-making, and the identification of targets for revascularization.⁷⁷

3.1.5.3 Role of the exercise electrocardiogram

Exercise ECG has inferior diagnostic performance compared with diagnostic imaging tests, and has limited power to rule-in or rule-out obstructive CAD.⁷³ Since the publication of the previous version of these Guidelines, randomized clinical trials (RCTs) have compared the effects of diagnostic strategies based on exercise ECG or an imaging diagnostic test^{6,78,79} on clinical outcomes. These studies have shown that the addition of coronary CTA^{5,6,78,80} or functional imaging⁷⁹ clarifies the diagnosis, enables the targeting of preventive therapies and interventions, and potentially reduces the risk of MI compared with an exercise ECG. Some, although not all, registry studies have also shown similar benefits regarding the use of an imaging diagnostic test in patients treated in everyday clinical practice.^{81,82} Therefore, these Guidelines recommend the use of an imaging diagnostic test instead of exercise ECG as the initial test for to diagnose obstructive CAD.

An exercise ECG alone may be considered as an alternative to diagnose obstructive CAD if imaging tests are not available, keeping in mind the risk of false-negative and false-positive test results.^{73,83} An exercise ECG is of no diagnostic value in patients with ECG abnormalities that prevent interpretation of the ST-segment changes during stress (i.e. LBBB, paced rhythm, Wolff-Parkinson-White syndrome, ≥ 0.1 mV ST-segment depression on resting ECG, or who are being treated with digitalis). An exercise ECG provides

complementary clinically useful information beyond ECG changes and valuable prognostic information. Therefore, application of an exercise ECG may be considered in selected patients to complement clinical evaluation for the assessment of symptoms, ST-segment changes, exercise tolerance, arrhythmias, blood pressure (BP) response, and event risk.

3.1.5.4 Selection of diagnostic tests

Either a functional or anatomical test can be used to establish a diagnosis of obstructive CAD. A summary of the main diagnostic pathways is displayed in Figure 4. For revascularization decisions, information on both anatomy and ischaemia is needed.

3.1.5.5 The impact of clinical likelihood on the selection of a diagnostic test

Each non-invasive diagnostic test has a particular range of clinical likelihood of obstructive CAD where the usefulness of its application is maximal. The likelihood ratios of the tests constitute useful parameters of their abilities to correctly classify patients, and can be used to facilitate the selection of the most useful test in any given patient.^{73,84} Given a clinical likelihood of obstructive CAD and the likelihood ratio of a particular test, one can assess the post-test probability of obstructive CAD after performing such a test. Using this approach, one can estimate the optimal ranges of clinical likelihood for each test, where they can reclassify patients from intermediate to either low or high post-test probability of CAD (Figure 5).⁷³

Coronary CTA is the preferred test in patients with a lower range of clinical likelihood of CAD, no previous diagnosis of CAD, and characteristics associated with a high likelihood of good image quality. It detects subclinical coronary atherosclerosis, but can also accurately rule out both anatomically and functionally significant CAD (Figure 5). It has higher accuracy values when low clinical likelihood populations are subjected to examination.⁸⁵ Trials evaluating outcomes after coronary CTA to date have mostly included patients with a low clinical likelihood.^{4,5}

The non-invasive functional tests for ischaemia typically have better rule-in power. In outcome trials, functional imaging tests have been associated with fewer referrals for downstream ICA compared with a strategy relying on anatomical imaging.^{55,76,86} Before revascularization decisions can be made, functional evaluation of ischaemia (either non-invasive or invasive) is required in most patients. Therefore, functional non-invasive testing may be preferred in patients at the higher end of the range of clinical likelihood if revascularization is likely or the patient has previously diagnosed CAD.

Patients in whom CAD is suspected, but who have a very low clinical likelihood ($\leq 5\%$) of CAD, should have other cardiac causes of chest pain excluded and their cardiovascular risk factors adjusted, based on a risk-score assessment. In patients with repeated, unprovoked attacks of anginal symptoms mainly at rest, vasospastic angina should be considered, diagnosed, and treated appropriately (see section 6).

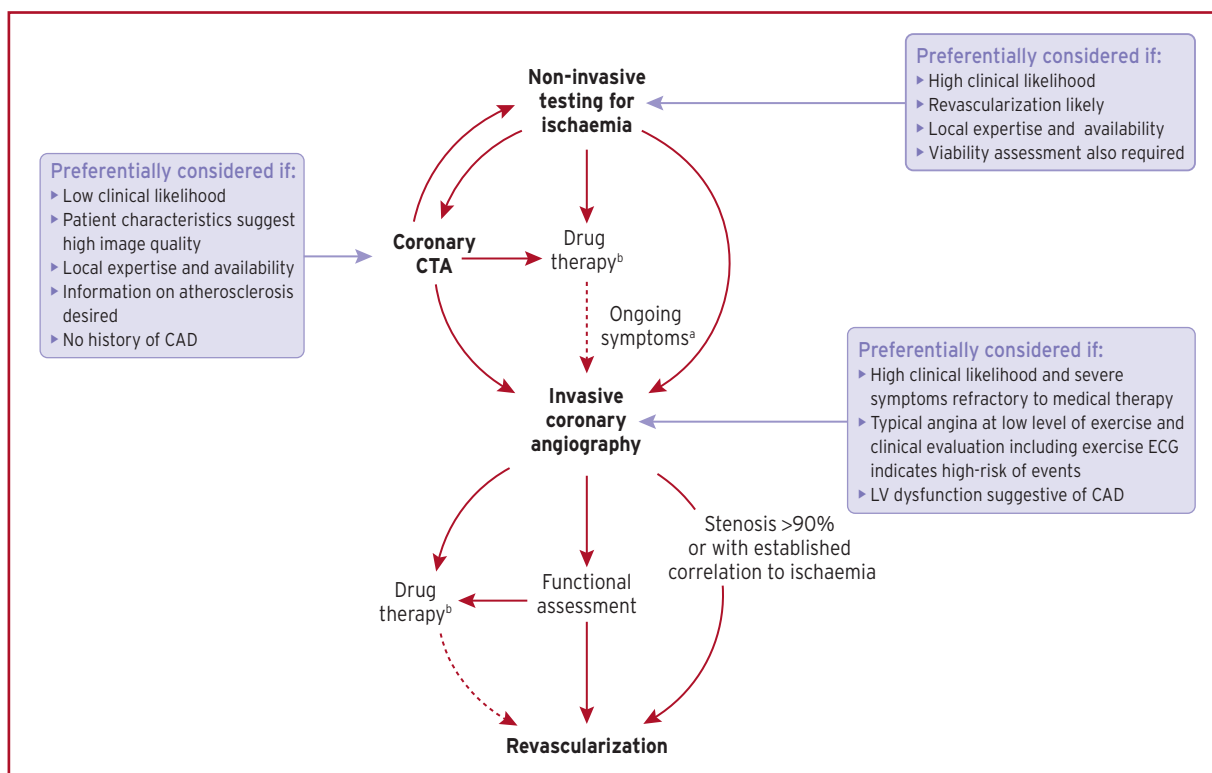

Figure 4 Main diagnostic pathways in symptomatic patients with suspected obstructive coronary artery disease. Depending on clinical conditions and the healthcare environment, patient workup can start with either of three options: non-invasive testing, coronary computed tomography angiography, or invasive coronary angiography. Through each pathway, both functional and anatomical information is gathered to inform an appropriate diagnostic and therapeutic strategy. Risk-factor modification should be considered in all patients. CAD = coronary artery disease; CTA = computed tomography angiography; ECG = electrocardiogram; LV = left ventricular. ^aConsider microvascular angina. ^bAntianginal medications and/or risk-factor modification.

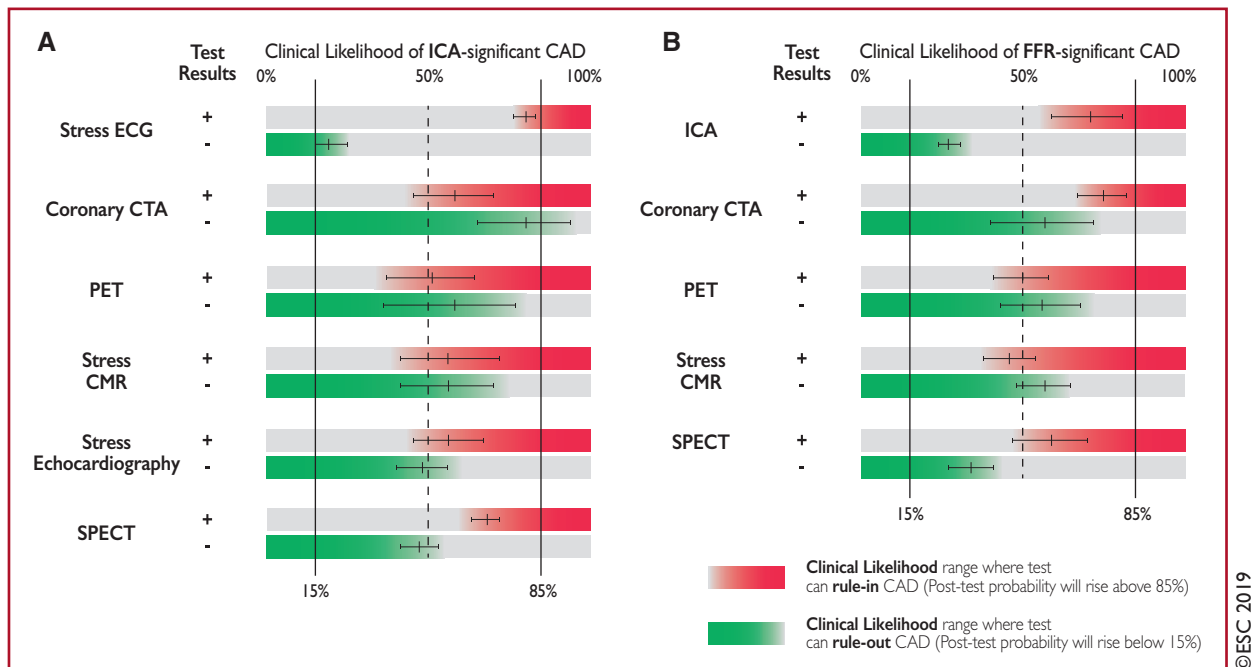

Figure 5 Ranges of clinical likelihood of coronary artery disease in which a given test can rule-in (red) or rule-out (green) obstructive coronary artery disease. (A) Reference standard is anatomical assessment using invasive coronary angiography. (B) Reference standard is functional assessment using fractional flow reserve. Note in (B) that the data with stress echocardiography and single-photon emission computed tomography are more limited than with the other techniques.⁷³ The crosshairs mark the mean values and their 95% confidence intervals. Figure adapted from Knuuti *et al.*⁷³ CAD = coronary artery disease; CMR = cardiac magnetic resonance; CTA = computed tomography angiography; ECG = electrocardiogram; FFR = fractional flow reserve; ICA = invasive coronary angiography; PET = positron emission tomography; SPECT = single-photon emission computed tomography.

In addition to diagnostic accuracy and clinical likelihood, the selection of a non-invasive test depends on other patient characteristics, local expertise, and the availability of tests. Some diagnostic tests may perform better in some patients than others. For example, irregular heart rate and the presence of extensive coronary calcification are associated with increased likelihood of non-diagnostic image quality of coronary CTA, and it is not recommended in such patients.⁸⁵ Stress echocardiography or SPECT perfusion imaging can be combined with dynamic exercise testing, and may be preferred if additional information available from the exercise test, such as exercise tolerance or heart rate response to exercise, is considered important. Exercise ECG cannot be used for diagnostic purposes in the presence of ECG abnormalities that prevent the evaluation of ischaemia. Risks related to different diagnostic tests need to be weighed against the benefits to the individual.⁸⁷ For example, exposure to ionizing radiation associated with coronary CTA and nuclear perfusion imaging needs to be taken into account, especially in young individuals.⁸⁷ Similarly, contraindications to pharmacological stressors and contrast agents (iodine-based contrast agents and gadolinium-based chelates) need to be taken into account. When testing is used appropriately, the clinical benefit from accurate diagnosis and therapy exceeds the projected risks of testing itself.⁸⁷

3.1.5.6 Invasive testing

For diagnostic purposes, ICA is only necessary in patients with suspected CAD in cases of inconclusive non-invasive testing or, exceptionally, in patients from particular professions, due to regulatory issues.⁸⁸

However, ICA may be indicated if non-invasive assessment suggests high event risk for determination of options for revascularization.⁸⁸

In a patient with a high clinical likelihood of CAD, and symptoms unresponsive to medical therapy or with typical angina at a low level of exercise, and initial clinical evaluation indicates a high event risk, early ICA without previous non-invasive risk stratification may be reasonable to identify lesions potentially amenable to revascularization (Figure 4). Invasive functional assessment should complement ICA, especially in patients with coronary stenoses of 50–90% or multivessel disease, given the frequent mismatch between the angiographic and haemodynamic severities of coronary stenoses.^{89–91} Systematic integration of ICA with FFR has been shown to result in changes to the management strategies of 30–50% of patients undergoing elective ICA.^{92,93} Methods used to perform ICA have improved substantially, resulting in a reduction of complication rates with rapid ambulation. This is especially true for ICA performed via the radial artery.⁹⁴ The composite rate of major complications associated with routine femoral diagnostic catheterization—mainly bleeding requiring blood transfusions—is still 0.5–2%.⁹⁵ The composite rate of death, MI, or stroke is of the order of 0.1–0.2%.⁹⁶ ICA should not be performed in patients with angina who refuse invasive procedures, prefer to avoid revascularization, who are not candidates for percutaneous coronary intervention (PCI) or coronary artery bypass grafting (CABG), or in whom revascularization is not expected to improve functional status or quality of life. Intracoronary techniques for the diagnostic assessment of coronary anatomy are briefly mentioned in the [Supplementary Data](#) of this document.

Use of diagnostic imaging tests in the initial diagnostic management of symptomatic patients with suspected coronary artery disease

Recommendations	Class ^a	Level ^b
Non-invasive functional imaging for myocardial ischaemia ^c or coronary CTA is recommended as the initial test to diagnose CAD in symptomatic patients in whom obstructive CAD cannot be excluded by clinical assessment alone. ^{4,5,55,73,78–80}	I	B
It is recommended that selection of the initial non-invasive diagnostic test is done based on the clinical likelihood of CAD and other patient characteristics that influence test performance, ^d local expertise, and the availability of tests.	I	C
Functional imaging for myocardial ischaemia is recommended if coronary CTA has shown CAD of uncertain functional significance or is not diagnostic. ^{4,55,73}	I	B
Invasive coronary angiography is recommended as an alternative test to diagnose CAD in patients with a high clinical likelihood, severe symptoms refractory to medical therapy or typical angina at a low level of exercise, and clinical evaluation that indicates high event risk. Invasive functional assessment must be available and used to evaluate stenoses before revascularization, unless very high grade (>90% diameter stenosis). ^{71,72,74}	I	B
Invasive coronary angiography with the availability of invasive functional evaluation should be considered for confirmation of the diagnosis of CAD in patients with an uncertain diagnosis on non-invasive testing. ^{71,72}	IIa	B
Coronary CTA should be considered as an alternative to invasive angiography if another non-invasive test is equivocal or non-diagnostic.	IIa	C
Coronary CTA is not recommended when extensive coronary calcification, irregular heart rate, significant obesity, inability to cooperate with breath-hold commands, or any other conditions make obtaining good image quality unlikely.	III	C
Coronary calcium detection by CT is not recommended to identify individuals with obstructive CAD.	III	C

CAD = coronary artery disease; CT = computed tomography; CTA = computed tomography angiography.

^aClass of recommendation.

^bLevel of evidence

^cStress echocardiography, stress cardiac magnetic resonance, single-photon emission CT, or positron emission tomography.

^dCharacteristics determining ability to exercise, likelihood of good image quality, expected radiation exposure, and risks or contraindications.

©ESC 2019

Use of exercise electrocardiogram in the initial diagnostic management of patients with suspected coronary artery disease

Recommendations	Class ^a	Level ^b
Exercise ECG is recommended for the assessment of exercise tolerance, symptoms, arrhythmias, BP response, and event risk in selected patients. ^c	I	C
Exercise ECG may be considered as an alternative test to rule-in and rule-out CAD when non-invasive imaging is not available. ^{73,83}	IIb	B
Exercise ECG may be considered in patients on treatment to evaluate control of symptoms and ischaemia.	IIb	C
Exercise ECG is not recommended for diagnostic purposes in patients with ≥ 0.1 mV ST-segment depression on resting ECG or who are being treated with digitalis.	III	C

BP = blood pressure; CAD = coronary artery disease; ECG = electrocardiogram.

^aClass of recommendation.

^bLevel of evidence.

^cWhen this information will have an impact on diagnostic strategy or management.

©ESC 2019

3.1.6 Step 6: Assessment of event risk

Assessment of event risk is recommended in every patient being evaluated for suspected CAD or with a newly diagnosed CAD, as it has major impacts on therapy decisions. The process of risk stratification serves to identify patients at high event risk who will benefit from revascularization beyond the amelioration of symptoms. Event risk stratification is usually based on the assessments used to make a diagnosis of CAD. All patients should undergo cardiovascular event risk

stratification using clinical evaluation, the assessment of LV function by resting echocardiography, and, in the majority of cases, non-invasive assessment of ischaemia or coronary anatomy. Although the diagnostic value of an exercise ECG is limited,⁷³ the occurrence of ST-segment depression at a low workload combined with exertional symptoms (angina or dyspnoea), low exercise capacity, complex ventricular ectopy, or arrhythmias and abnormal BP response are markers of a high risk of cardiac mortality.^{97–100} Patients with typical

Table 6 Definitions of high event risk for different test modalities in patients with established chronic coronary syndromes^a 102–104

Exercise ECG	Cardiovascular mortality >3% per year according to Duke Treadmill Score
SPECT or PET perfusion imaging	Area of ischaemia ≥10% of the left ventricle myocardium
Stress echocardiography	≥3 of 16 segments with stress-induced hypokinesia or akinesia
CMR	≥2 of 16 segments with stress perfusion defects or ≥3 dobutamine-induced dysfunctional segments
Coronary CTA or ICA	Three-vessel disease with proximal stenoses, LM disease, or proximal anterior descending disease
Invasive functional testing	FFR ≤0.8, iwFR ≤0.89

CTA = computed tomography angiography; CMR = cardiac magnetic resonance; ECG = electrocardiogram; FFR = fractional flow reserve; ICA = invasive coronary angiography; iwFR = instantaneous wave-free ration (instant flow reserve); LM = left main; PET = positron emission tomography; SPECT; single-photon emission computed tomography.
^aFor detailed explanations, refer to the [Supplementary Data](#).

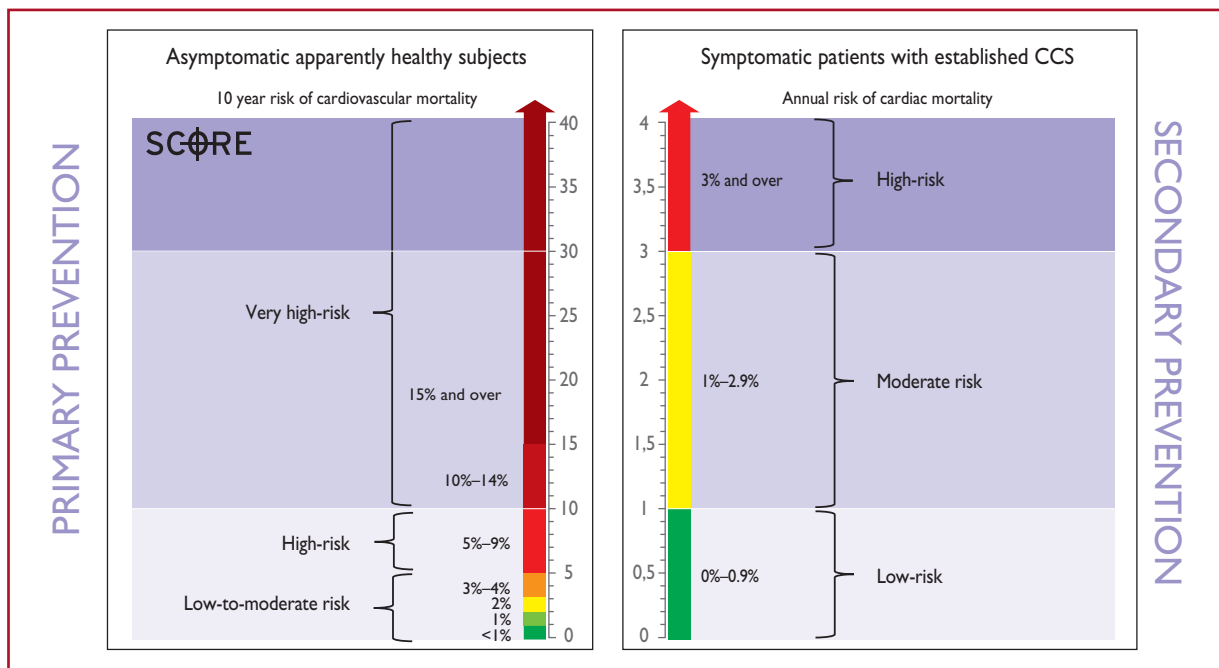

Figure 6 Comparison of risk assessments in asymptomatic apparently healthy subjects (primary prevention) and patients with established chronic coronary syndromes (secondary prevention). Note that in asymptomatic subjects (left panel), SCORE estimates 10 year cardiovascular mortality, while in symptomatic patients (right panel), annual cardiac mortality is estimated. CCS = chronic coronary syndromes; SCORE = Systematic COronary Risk Evaluation.

angina and LV systolic dysfunction in a pattern that indicates CAD are also at high risk of cardiac mortality.¹⁰¹ ICA for risk stratification will only be required in a selected subgroup of patients and additional FFR may be required for event risk stratification as appropriate (Figure 4). Risk assessment in patients with HF and LV dysfunction, asymptomatic patients with known CAD, and patients with recurrent symptoms after previous coronary intervention is discussed in sections 4 and 5.

3.1.6.1 Definition of levels of risk

In patients with established CCS, the risk of annual cardiac mortality is used to describe the event risk. As in the previous version of the Guidelines,⁶⁰ high event risk is defined as a cardiac mortality rate >3% per year and low event risk as a cardiac mortality rate <1% per year.

The definitions of high event risk based on findings of diagnostic tests in symptomatic patients or in patients with established CCS are shown in Table 6.

Notably, the level of risk is different from the risk assessment based on SCORE in asymptomatic individuals without diabetes who are apparently healthy (see section 7). SCORE defines 10 year cardiovascular mortality in asymptomatic subjects. Differences in these risk-assessment tools and the scales are illustrated in Figure 6. The findings of different test modalities that correspond to high event risk are presented in Table 6 and are discussed in more detail in the Supplementary Data (sections 1.1 and 1.2).^{102–104} For all non-invasive tests presented in Table 6, a normal test result is associated with a low event risk.¹⁰⁵

Recommendations on risk assessment

Recommendations	Class ^a	Level ^b
Risk stratification is recommended based on clinical assessment and the result of the diagnostic test initially employed to diagnose CAD. ^{6,75,102,103}	I	B
Resting echocardiography is recommended to quantify LV function in all patients with suspected CAD.	I	C
Risk stratification, preferably using stress imaging or coronary CTA (if permitted by local expertise and availability), or alternatively exercise stress ECG (if significant exercise can be performed and the ECG is amenable to the identification of ischaemic changes), is recommended in patients with suspected or newly diagnosed CAD. ^{6,75,102,106}	I	B
In symptomatic patients with a high-risk clinical profile, ICA complemented by invasive physiological guidance (FFR) is recommended for cardiovascular risk stratification, particularly if the symptoms are responding inadequately to medical treatment and revascularization is considered for improvement of prognosis. ^{104,107}	I	A
In patients with mild or no symptoms, ICA complemented by invasive physiological guidance (FFR/iwFR) is recommended for patients on medical treatment, in whom non-invasive risk stratification indicates a high event risk and revascularization is considered for improvement of prognosis. ^{104,107}	I	A
ICA complemented by invasive physiological guidance (FFR) should be considered for risk-stratification purposes in patients with inconclusive or conflicting results from non-invasive testing. ⁷⁴	IIa	B
If coronary CTA is available for event risk stratification, additional stress imaging should be performed before the referral of a patient with few/no symptoms for ICA. ^{108,109}	IIa	B
Echocardiographic assessment of global longitudinal strain provides incremental information to LVEF and may be considered when LVEF is >35%. ^{110–114}	IIb	B
Intravascular ultrasound may be considered for the risk stratification of patients with intermediate LM stenosis. ^{115,116}	IIb	B
ICA is not recommended solely for risk stratification.	III	C

CAD = coronary artery disease; CTA = computed tomography angiography; ECG = electrocardiogram; FFR = fractional flow reserve; ICA = invasive coronary angiography; iwFR = instantaneous wave-free ratio; LM = left main; LV = left ventricular; LVEF = LV ejection fraction.

^aClass of recommendation.

^bLevel of evidence.

3.2 Lifestyle management

3.2.1 General management of patients with coronary artery disease

General management of CCS aims to reduce symptoms and improve prognosis through appropriate medications and interventions, and to control risk factors including lifestyle behaviours. Optimal medical therapy in the COURAGE (Clinical Outcomes Utilizing Revascularization and Aggressive Drug Evaluation) trial included the promotion of medication adherence, behavioural counselling, and support for the managing lifestyle risk factors delivered by nurse case managers.¹¹⁷ Achievement of optimal management may be best accomplished through a multidisciplinary team approach that can provide tailored and flexible support to patients.

Patient-reported outcome measures can provide relevant and systematic information about patients' symptoms, functioning, and concerns. Patient-reported outcome measures are increasingly being implemented sequentially in healthcare, and have been shown to improve clinical care and patient experiences, communication between providers and patients (including sensitive subjects), save time in consultations, and improve provider satisfaction.¹¹⁸

3.2.2 Lifestyle modification and control of risk factors

Implementing healthy lifestyle behaviours decreases the risk of subsequent cardiovascular events and mortality, and is additional to appropriate secondary prevention therapy. Lifestyle recommendations and interventions are described in more detail in the 2016 ESC Guidelines on CVD prevention in clinical practice.¹⁵ Lifestyle factors are important and the implementation of healthy behaviours (including smoking cessation, recommended physical activity, a healthy diet, and maintaining a healthy weight; see *Table 7*) significantly decreases the risk of future cardiovascular events and death, even when controlling for evidence-based secondary prevention therapy and interventions.^{119–122} Benefits are evident as early as 6 months after an index event.¹¹⁹

Primary care providers have an important role to play in prevention. The primary care arm of the EUROACTION cluster randomized trial demonstrated that a nurse-co-ordinated programme in primary care was more effective in helping patients achieve lifestyle and risk-factor goals than usual care.¹²³ Practice nurses in the

Netherlands were found to be as effective as general practitioners in decreasing cardiovascular risk in another randomized study.¹²³

3.2.2.1 Smoking

Smoking cessation improves the prognosis in patients with CCS, including a 36% risk reduction in mortality for those who quit.¹²⁴

Measures to promote smoking cessation include brief advice, counselling and behavioural interventions, and pharmacological therapy including nicotine replacement. Patients should also avoid passive smoking.

Brief advice, relative to no treatment, doubles the likelihood of smoking cessation in the short-term, but more intensive advice and support (behavioural interventions, telephone support, or self-help measures) is more effective than brief advice, especially if continued over 1 month.^{125,126} All forms of nicotine-replacement therapy, bupropion, and varenicline are more effective in increasing smoking cessation than control, and combining behavioural and pharmacological approaches is effective and highly recommended.¹²⁵ A network meta-analysis of 63 clinical trials (including eight trials in CVD patients) found no increase in major adverse cardiovascular events linked to nicotine-replacement therapy, bupropion, or varenicline.¹²⁷ Nicotine-replacement therapy was associated with minor events such as arrhythmias and angina, and bupropion appeared to have a protective effect against major adverse cardiovascular events.¹²⁷ The use of e-cigarettes is considered to be a reduced-harm alternative to conventional cigarettes, but they are not harm-free. Newer devices can deliver higher nicotine contents, and e-cigarettes emit other constituents such as carbonyls and fine and ultrafine particulates.¹²⁸ Although previous systematic reviews have found very limited and inconsistent evidence that e-cigarettes (primarily first-generation devices) are useful in improve smoking cessation compared with placebo or nicotine-replacement therapy, a recent large clinical trial found e-cigarettes to be more effective than nicotine-replacement therapy in smoking cessation.^{129–133} In this randomised trial of 886 smokers, those assigned to e-cigarettes had a sustained 1 year abstinence rate of 18% compared with 9.9% for nicotine-replacement therapy [relative risk, 1.83; 95% confidence interval (CI) 1.30 to 2.58; $P < 0.001$].¹³³

In clinical encounters with smokers, clinicians should follow the 'Five As': ask about smoking, advise to quit, assess readiness to quit, assist with smoking cessation (pharmacological support and referral for behavioural counselling), and arrange follow-up (*Figure 7*).

Table 7 Lifestyle recommendations for patients with chronic coronary syndromes

Lifestyle factor	
Smoking cessation	Use pharmacological and behavioural strategies to help patients quit smoking. Avoid passive smoking.
Healthy diet	Diet high in vegetables, fruit, and wholegrains. Limit saturated fat to <10% of total intake. Limit alcohol to <100 g/week or 15 g/day.
Physical activity	30–60 min moderate physical activity most days, but even irregular activity is beneficial.
Healthy weight	Obtain and maintain a healthy weight (<25 kg/m ²), or reduce weight through recommended energy intake and increased physical activity.
Other	Take medications as prescribed. Sexual activity is low risk for stable patients not symptomatic at low-to-moderate activity levels.



Figure 7 The five As of smoking cessation.

3.2.2.2 Diet and alcohol

Unhealthy diets are a leading contributor to CAD and its progression, and changes to healthy eating patterns in patients with CCS have resulted in a reduction in mortality and cardiovascular events¹³⁴ (recommended diet characteristics are detailed in Table 8).

A Mediterranean dietary pattern high in fruit, vegetables, legumes, fibre, polyunsaturated fats, nuts, and fish, avoiding or limiting refined carbohydrates, red meat, dairy, and saturated fat, is advocated.^{135–138} Although light-to-moderate alcohol intake (1–2 drinks per day) does not increase risk of MI, levels >100 g per week were associated with higher all-cause and other CVD mortality in a large individual-data meta-analysis.¹³⁹ The Global Burden of Disease 1990–2016 analysis concluded that zero alcohol intake was the level at which risk for death and disability was minimized.¹⁴⁰

3.2.2.3 Weight management

In a population-based study, lifetime risk of incident CVD, and cardiovascular morbidity and mortality, were higher in those who were overweight or obese compared with those with a normal BMI (20–25 kg/m²). Obesity was associated with a shorter overall lifespan, and overweight was associated with developing CVD at an earlier age.¹⁴³ Waist circumference is a marker of central obesity and is strongly associated with developing CVD and diabetes. Waist circumference ≤94 cm for men (<90 cm for South Asian and Asian men) and ≤80 cm for women is recommended.

In subjects with CAD, intentional weight loss is associated with a significantly lower risk of adverse clinical outcomes.¹⁴⁴ Although there has been much argument regarding the relative benefits of low-fat vs. low-carbohydrate diets, Gardner *et al.*¹⁴⁵ found similar weight loss and benefits in patients randomized to either healthy low-fat or low-carbohydrate diets. This finding held, regardless of patients' genotype patterns and baseline insulin secretion. Healthy diets with energy intake limited to the amount needed to obtain and maintain a healthy weight (BMI <25 kg/m²), and increasing physical activity, are recommended for weight management.

Table 8 Healthy diet characteristics^{134,137,141,142}

Characteristics
Increase consumption of fruits and vegetables (≥200 g each per day).
35–45 g of fibre per day, preferably from wholegrains.
Moderate consumption of nuts (30 g per day, unsalted).
1–2 servings of fish per week (one to be oily fish).
Limited lean meat, low-fat dairy products, and liquid vegetable oils.
Saturated fats to account for <10% of total energy intake; replace with polyunsaturated fats.
As little intake of trans unsaturated fats as possible, preferably no intake from processed food, and <1% of total energy intake.
≤5–6 g of salt per day.
If alcohol is consumed, limiting intake to ≤100 g/week or <15 g/day is recommended.
Avoid energy-dense foods such as sugar-sweetened soft drinks.

3.2.2.4 Physical activity

Exercise has been referred to as a 'poly pill' due to its numerous beneficial effects on cardiovascular risk factors and cardiovascular system physiology.^{146,147} Exercise improves angina through enhanced oxygen delivery to the myocardium, and increasing exercise capacity is an independent predictor of increased survival among men and women with CCS, even among those with a regimen consistent with evidence-based management.^{122,147,148}

Every 1 mL/kg/min increase in exercise peak oxygen consumption was associated with a 14–17% reduction of risk for cardiovascular and all-cause death in women and men.¹²²

Physical activity recommendations for patients with CCS are 30–60 min of moderate-intensity aerobic activity ≥5 days per week.¹⁴⁷ Even irregular leisure-time physical activity decreases mortality risk among previously sedentary patients,¹⁴⁹ and increasing activity is associated with lower cardiovascular mortality.¹⁵⁰ Previously sedentary patients will need support to work up to 30–60 min most days, reassurance that exercise is beneficial, and education regarding what to do if angina occurs while being active. Resistance exercises maintain muscle mass, strength, and function and, with aerobic activity, have benefits regarding insulin sensitivity and control of lipids and BP.

3.2.2.5 Cardiac rehabilitation

Exercise-based cardiac rehabilitation has consistently demonstrated its effectiveness in reducing cardiovascular mortality and hospitalizations compared with no exercise controls in patients with CAD, and this benefit persists into the modern era.^{151–153} Most patients participating in cardiac rehabilitation are referred following an acute MI or after revascularization, with 0–24% of patients found to be referred for CCS in 12 European countries.¹⁵⁴ Importantly, the benefits of cardiac rehabilitation occur across diagnostic categories.^{151–153}

3.2.2.6 Psychosocial factors

Patients with heart disease have a two-fold increased risk of mood and anxiety disorders compared with people without heart disease.^{155,156} Psychosocial stress, depression, and anxiety are associated with worse outcomes, and make it difficult for patients to make positive changes to their lifestyles or adhere to a therapeutic regimen.

The ESC Prevention Guidelines recommend assessment for psychosocial risk factors.¹⁵ Clinical trials have shown that psychological (e.g. counselling and/or cognitive behavioural therapy) and pharmacological interventions have a beneficial effect on depression, anxiety, and stress, with some evidence of a reduction in cardiac mortality and events compared with placebo.^{157–159}

3.2.2.7 Environmental factors

Air pollutants are estimated to be one of the 10 leading risk factors for global mortality. Exposure to air pollution increases risk of MI, as well as hospitalization and death from heart failure, stroke, and arrhythmia.¹⁶⁰ Patients with CCS should avoid heavily traffic-congested areas. Air purifiers with high-efficiency particulate air ('HEPA') filters reduce indoor pollution, and wearing N95 respirator face masks in heavily polluted areas has been shown to be protective.¹⁶⁰ Environmental noise also increases the risk of CVD.¹⁶¹ Policies and regulations that reduce air pollution and environmental noise should be supported, and patients should be advised about these risks.

3.2.2.8 Sexual activity

Patients with CCS often worry about the cardiovascular risk associated with sexual activity and/or experience sexual dysfunction.¹⁶² The risk of triggering sudden death or an acute MI is very low, especially when sexual activity is with a stable partner in a familiar environment without stress, or excessive intake of food or alcohol beforehand.^{163,164} Although sexual activity transiently increases the risk of MI, it is the cause of <1% of acute MIs and <1–1.7% of sudden deaths occur during sexual activity.¹⁶⁴ The energy expenditure during sexual activity is generally low-to-moderate (3–5 metabolic equivalents) and climbing two flights of stairs is often used as an equivalent activity in terms of energy expended.^{163,164} Regular physical activity decreases the risk of adverse events during sexual activity.¹⁶⁵ Sexual dysfunction in patients with CCS includes decreased libido and sexual activity, and a high prevalence of erectile dysfunction. Sexual dysfunction may be caused by underlying vascular conditions, psychosocial factors, specific medications, number of medications, and changes in relationships.¹⁶⁶ Thiazide diuretics and beta-blockers (except nebivolol) may negatively influence erectile function, but studies published since 2011 have not found a consistent relationship between most contemporary cardiovascular medications and erectile dysfunction.^{162,164,165} Phosphodiesterase-5 inhibitors to treat erectile dysfunction are generally safe in CCS patients, but should not be used in those taking nitrates.¹⁶⁴ Healthcare providers should ask patients about sexual activity, and offer advice and counselling.

3.2.2.9 Adherence and sustainability

Adherence to lifestyle modifications and to medications is a challenge. A systematic review of epidemiological studies indicated that a substantial proportion of patients do not adhere to cardiovascular medications, and that 9% of cardiovascular events in Europe were attributable to poor adherence.¹⁶⁷ In older men with ischaemic heart disease, greater adherence to medication guidelines appears to be positively associated with better clinical outcomes, independent of other conditions.¹⁶⁸ Polypharmacy plays a negative role in adherence to treatment,¹⁶⁹ and complexity of drug regimen is associated with

non-adherence and higher rates of hospitalizations.¹⁷⁰ Drug prescriptions should prioritize medications that have proved their benefit with the highest level of evidence and those for whom the amplitude of benefit is largest. Simplifying medication regimens may help, and there is some evidence of benefits of cognitive educational strategies, electronically monitored feedback, and support by nurse case managers. Medication reviews by primary care providers may be helpful in patients with multiple comorbidities to minimize the risk of adverse interactions and to simplify medication regimens.^{117,171–173}

Promoting behaviour change and medication adherence should be part of each clinical encounter in primary care and specialist follow-up, emphasising its importance, referring for support when needed, and congratulating patients for their achievements. Long-term support (intensive in the first 6 months, then every 6 months for 3 years) in the GOSPEL (Global secondary prevention strategies to limit event recurrence after myocardial infarction) trial resulted in significant improvements in risk factors, and decreases in several clinical mortality and morbidity endpoints.¹²¹ The Multicenter Lifestyle Demonstration Project showed that CCS patients could make intensive lifestyle changes and improve their risk factors and fitness, with changes sustained at 12 months.¹⁷⁴

3.2.2.10 Influenza vaccination

An annual influenza vaccination can improve prevention of acute MI in patients with CCS,^{175,176} change HF prognosis,¹⁷⁷ and decrease cardiovascular mortality in adults aged ≥65 years.^{178–180} Therefore, annual influenza vaccination is recommended for patients with CAD, especially in the elderly.

Recommendations on lifestyle management

Recommendations	Class ^a	Level ^b
Improvement of lifestyle factors in addition to appropriate pharmacological management is recommended. ^{119–122,124,148–153}	I	A
Cognitive behavioural interventions are recommended to help individuals achieve a healthy lifestyle. ^{181–183}	I	A
Exercise-based cardiac rehabilitation is recommended as an effective means for patients with CCS to achieve a healthy lifestyle and manage risk factors. ^{151–153}	I	A
Involvement of multidisciplinary healthcare professionals (e.g. cardiologists, GPs, nurses, dietitians, physiotherapists, psychologists, and pharmacists) is recommended. ^{121,123,181,184}	I	A
Psychological interventions are recommended to improve symptoms of depression in patients with CCS. ^{126,157}	I	B
Annual influenza vaccination is recommended for patients with CCS, especially in the elderly. ^{175,176,178,179,185–187}	I	B

CCS = chronic coronary syndrome; GPs = general practitioners.

^aClass of recommendation.

^bLevel of evidence.

3.3 Pharmacological management

The aims of pharmacological management of CCS patients are to reduce angina symptoms and exercise-induced ischaemia, and to prevent cardiovascular events.

Immediate relief of anginal symptoms, or the prevention of symptoms under circumstances likely to elicit angina, is usually obtained with rapidly acting formulations of nitroglycerin. Anti-ischaemic drugs—but also lifestyle changes, regular exercise training, patient education, and revascularization—all play a role in minimizing or eradicating symptoms over the long-term (long-term prevention).

Prevention of cardiovascular events targets MI and death associated with CAD, and focuses primarily on reducing the incidence of acute thrombotic events and the development of ventricular dysfunction. Strategies include pharmacological and lifestyle interventions, as detailed in the 2016 European Guidelines on CVD prevention in clinical practice.¹⁵

3.3.1 Anti-ischaemic drugs

3.3.1.1 General strategy

Optimal treatment can be defined as the treatment that satisfactorily controls symptoms and prevents cardiac events associated with CCS, with maximal patient adherence and minimal adverse events.^{188–191} However, there is no universal definition of an optimal treatment in patients with CCS, and drug therapies must be adapted to each patient's characteristics and preferences.¹⁹² Initial drug therapy usually consists of one or two antianginal drugs, as necessary, plus drugs for secondary prevention of CVD.¹⁹³ The initial choice of antianginal drug(s) depends on the expected tolerance related to the individual patient's profile and comorbidities, potential drug interactions with co-administered therapies, the patient's preferences after being informed of potential adverse effects, and drug availability. Whether combination therapy with two antianginal drugs [e.g. a beta-blocker and a calcium channel blocker (CCB)] is superior to monotherapy with any class of antianginal drug in reducing clinical events remains unclear.^{194–197}

Beta-adrenergic blockers or CCBs are recommended as the first choice, although no RCT to date has compared this strategy to an alternative strategy using initial prescription of other anti-ischaemic drugs, or the combination of a beta-blocker and a CCB.^{191,195} The results of a network meta-analysis of 46 studies and 71 treatment comparisons supported the initial combination of a beta-blocker and a CCB.¹⁹⁸ The same meta-analysis suggested that several second-line add-on anti-ischaemic drugs (long-acting nitrates, ranolazine, trimetazidine, and, to a lesser extent, ivabradine) may prove beneficial in combination with a beta-blocker or a CCB as first-line therapy, while no data were available for nicorandil. However, it should be noted that the study pooled RCTs using endpoints of nitrate use, angina frequency, time to angina or to ST-segment depression, and total exercise time, and no study or meta-analysis has yet assessed with sufficient power the influence of combining a beta-blocker or a CCB with a second-line anti-ischaemic drug on morbidity or mortality events.¹⁹⁸ Regardless of the initial strategy, response to initial antianginal therapy should be reassessed after 2–4 weeks of treatment initiation.

3.3.1.2 Available drugs

Anti-ischaemic drugs have proved benefits regarding symptoms associated with myocardial ischaemia but do not prevent cardiovascular

events in most patients with CCS. [Supplementary Table 3](#) in the [Supplementary Data](#) summarizes the principal major side effects, contraindications, drug–drug interactions, and precautions relating to anti-ischaemic drugs. [Supplementary Table 2](#) summarizes the main mechanisms of action of anti-ischaemic drugs.

3.3.1.2.1 Nitrates.

Short-acting nitrates for acute effort angina

Sublingual and spray nitroglycerin formulations provide immediate relief of effort angina. Spray nitroglycerin acts more rapidly than sublingual nitroglycerin.¹⁹⁹ At the onset of angina symptoms, the patient should rest in a sitting position (standing promotes syncope, and lying down enhances venous return and preload) and take nitroglycerin (0.3–0.6 mg tablet sublingually and not swallowed, or 0.4 mg spray to the tongue and not swallowed or inhaled) every 5 min until the pain disappears, or a maximum of 1.2 mg has been taken within 15 min. During this time frame, if angina persists, immediate medical attention is needed. Nitroglycerin can be administered for prophylaxis before physical activities known to provoke angina. Isosorbide dinitrate (5 mg sublingually) has a slightly slower onset of action than nitroglycerin due to hepatic conversion to mononitrate. The effect of isosorbide dinitrate may last ≤ 1 h if the drug is taken sublingually or persist for several hours if the drug is taken by oral ingestion.

Long-acting nitrates for angina prophylaxis

Long-acting nitrate formulations (e.g. nitroglycerin, isosorbide dinitrate, and isosorbide mononitrate) should be considered as second-line therapy for angina relief when initial therapy with a beta-blocker or non-dihydropyridine (non-DHP) CCB is contraindicated, poorly tolerated, or insufficient to control symptoms. In fact, there is a paucity of data comparing nitrates with beta-blockers or CCB from which to draw firm conclusions about their relative efficacies.²⁰⁰ When taken over a prolonged period, long-acting nitrates provoke tolerance with loss of efficacy, which requires prescription of a nitrate-free or nitrate-low interval of ~ 10 –14 h.²⁰¹ Nitroglycerin can be administered orally or transdermally through slow-release patch systems. Bioavailability of isosorbide dinitrate depends on the interindividual variability in hepatic conversion and is generally lower than the bioavailability of isosorbide mononitrate (its active metabolite), which is 100% bioavailable. Titration of dose is essential with all formulations to obtain the maximal control of symptoms at a tolerable dose. Discontinuation should be tapered and not abrupt to avoid a rebound increase in angina.²⁰² The most common side effects are hypotension, headache, and flushing. Contraindications include hypertrophic obstructive cardiomyopathy, severe aortic valvular stenosis, and co-administration of phosphodiesterase inhibitors (e.g. sildenafil, tadalafil, or vardenafil) or riociguat.

3.3.1.2.2 Beta-blockers. The dose of beta-blockers should be adjusted to limit the heart rate to 55–60 b.p.m. (beats per minute) at rest.^{203,204} Discontinuation should be tapered and not abrupt. Beta-blockers can be combined with DHP CCBs to reduce DHP-induced tachycardia, but with uncertain incremental clinical value.^{205–208} Caution is warranted when a beta-blocker is combined with verapamil or diltiazem due to the potential for developing worsening of HF, excessive bradycardia, and/or atrioventricular block. Combination of a beta-blocker with a nitrate attenuates the reflex tachycardia of the latter. The principal side effects of beta-blockers are fatigue, depression, bradycardia, heart block, bronchospasm, peripheral

vasoconstriction, postural hypotension, impotence, and masking of hypoglycaemia symptoms.

In certain patients with recent MI and those with chronic HF with reduced ejection fraction, beta-blockers have been associated with a significant reduction in mortality and/or cardiovascular events,^{209–215} but the protective benefit in patients with CAD without prior MI or HF is less well established and lacks placebo-controlled trials.²¹⁶ A retrospective analysis of 21 860 matched patients from the REACH (REduction of Atherothrombosis for Continued Health) Registry showed no reduction in cardiovascular mortality with beta-blockers in patients with either CAD with risk factors only, known prior MI, or known CAD without MI.²¹⁷ In a retrospective national registry of 755 215 patients aged ≥ 65 years with a history of CAD without prior MI or HF with reduced ejection fraction undergoing elective PCI, beta-blocker use at discharge was not associated with any reduction in cardiovascular morbidity or mortality at 30 day and 3 year follow-up.²¹⁸ However, in patients with or without previous MI undergoing CABG, beta-blockers were associated with lower risk of long-term mortality and adverse cardiovascular events.²¹⁹ Other observational studies and meta-analyses have questioned the benefit of long-term (>1 year) beta-blocker therapy in patients with a previous MI.^{216,220–224} This is still a matter for debate,²²⁵ and uncertainties remain on the comparative role of beta-blockers and angiotensin-converting enzyme (ACE) inhibitors.

3.3.1.2.3 Calcium channel blockers. While CCBs improve symptoms and myocardial ischaemia, they have not been shown to reduce major morbidity endpoints or mortality in patients with CCS.^{192,226–228}

NON-DIHYDROPYRIDINE AGENTS (HEART RATE-LOWERING CALCIUM CHANNEL BLOCKERS)

Verapamil. Verapamil has a large range of approved indications, including all varieties of angina (effort, vasospastic, and unstable), supraventricular tachycardias, and hypertension. Indirect evidence suggests good safety but with risks of heart block, bradycardia, and HF. Compared with metoprolol, the antianginal activity was similar.²²⁹ Compared with atenolol in hypertension with CAD, verapamil is associated with fewer cases of diabetes, fewer anginal attacks,²³⁰ and less psychological depression.²³¹ Beta-blockade combined with verapamil is not advised (due to risk of heart block).

Diltiazem. Diltiazem, with its low-side effect profile, has advantages compared with verapamil in the treatment of effort angina. Like verapamil, it acts by peripheral vasodilation, relief of exercise-induced coronary constriction, a modest negative inotropic effect, and sinus node inhibition. There have been no outcome studies comparing diltiazem and verapamil.

In some selected patients, non-DHP agents may be combined with beta-blockers for the treatment of angina. However, on such occasions they must be used under close monitoring of patients' tolerance regarding excessive bradycardia or signs of HF. Use of non-DHP CCBs in patients with LV dysfunction is not advised.

DIHYDROPYRIDINE AGENTS

Long-acting nifedipine. This agent is a powerful arterial vasodilator with few serious side effects. Long-acting nifedipine has been especially well tested in hypertensive anginal patients when added to beta-

blockade.²³² In the large placebo-controlled ACTION (A Coronary disease Trial Investigating Outcome with Nifedipine gastrointestinal therapeutic system) trial, addition of long-acting nifedipine [60 mg o.d. (once a day)] to conventional treatment of angina had no effect on major cardiovascular event-free survival. Long-acting nifedipine proved to be safe, and reduced the need for coronary angiography and cardiovascular interventions.²³² Relative contraindications to nifedipine are few (severe aortic stenosis, hypertrophic obstructive cardiomyopathy, or HF), and careful combination with beta-blockade is usually feasible and desirable. Vasodilatory side effects include headache and ankle oedema.

Amlodipine. The very long half-life of amlodipine and its good tolerability make it an effective once-a-day antianginal and antihypertensive agent, setting it apart from drugs that are taken either twice or three times daily. Side effects are few, mainly ankle oedema. In patients with CCS and normal BP (~75% receiving a beta-blocker), amlodipine 10 mg/day reduced coronary revascularizations and hospitalizations for angina in a 24 month trial.²³³ Exercise-induced ischaemia is more effectively reduced by amlodipine, 5 mg titrated to 10 mg/day, than by the beta-blocker atenolol, 50 mg/day, and their combination is even better.²³⁴ However, the CCB–beta-blocker combination is often underused, even in some studies reporting 'optimally treated' stable effort angina.

3.3.1.2.4 Ivabradine. Ivabradine has been reported to be non-inferior to atenolol or amlodipine in the treatment of angina and ischaemia in patients with CCS.^{235,236} Adding ivabradine 7.5 mg b.i.d. [bis in die (twice a day)] to atenolol therapy gave better control of heart rate and anginal symptoms.²³⁷ In 10 917 patients with limiting previous angina enrolled in the morbidity–mortality evaluation of the BEAUTIFUL (I_f Inhibitor Ivabradine in Patients With Coronary Artery Disease and Left Ventricular Dysfunction) trial, ivabradine did not reduce the composite primary endpoint of cardiovascular death, hospitalization with MI, or HF.²³⁸ Also, in the SIGNIFY (Study Assessing the Morbidity–Mortality Benefits of the I_f Inhibitor Ivabradine in Patients with Coronary Artery Disease) study, consisting of 19 102 patients with CAD without clinical HF and a heart rate ≥ 70 b.p.m., there was no significant difference between the ivabradine group and the placebo group in the incidence of the primary composite endpoint of death from cardiovascular causes or non-fatal MI.²³⁹ Ivabradine was associated with an increase in the incidence of the primary endpoint among 12 049 patients with activity-limiting angina but not among those without activity-limiting angina ($P=0.02$ for interaction). In 2014, the European Medicines Agency issued recommendations to reduce the risk of bradycardia and placed ivabradine under additional monitoring.²⁴⁰ In aggregate, these results support the use of ivabradine as a second-line drug in patients with CCS.

3.3.1.2.5 Nicorandil. Nicorandil is a nitrate derivative of nicotinamide, with antianginal effects similar to those of nitrates or beta-blockers.^{241–244} Side effects include nausea, vomiting, and potentially severe oral, intestinal, and mucosal ulcerations.²⁴⁵

In the placebo-controlled IONA (Impact Of Nicorandil in Angina) trial ($n = 5126$), nicorandil significantly reduced the composite of coronary heart disease (CHD) death, non-fatal MI, or unplanned hospital admission for suspected anginal symptoms in patients with CCS, but there was no effect on death from ischaemic heart disease or non-

fatal MI.²⁴⁶ These results support the use of nicorandil as a second-line drug in patients with CCS.

3.3.1.2.6 Ranolazine. Ranolazine is a selective inhibitor of the late inward sodium current. Side effects include dizziness, nausea, and constipation. In addition, ranolazine increases QTc, and should therefore be used carefully in patients with QT prolongation or on QT-prolonging drugs.

In a placebo-controlled trial of 6560 patients with non-ST-segment elevation ACS, the addition of ranolazine to standard treatment did not prove effective in reducing the primary efficacy endpoint of cardiovascular death, MI, or recurrent ischaemia.²⁴⁷ However, in the relatively large subgroup of patients with chronic angina ($n = 3565$), significant reductions in recurrent ischaemia, worsening angina, and intensification of antianginal therapy were observed.²⁴⁸ In another placebo-controlled trial of patients with diabetes and CAD receiving one or two antianginal drugs, ranolazine reduced angina and sublingual nitroglycerin use with good tolerability.²⁴⁹ In the RIVER-PCI (Ranolazine for Incomplete Vessel Revascularization Post-Percutaneous Coronary Intervention) trial, ranolazine did not reduce the composite of ischaemia-driven revascularization or

hospitalization without revascularization in 2651 patients with a history of chronic angina and incomplete revascularization after PCI, including those with and without PCI for a CAD indication, nor did it reduce angina symptoms at 1 year.^{250,251}

These results support the use of ranolazine as a second-line drug in CCS patients with refractory angina despite commonly used antianginal agents such as beta-blockers, CCBs, and/or long-acting nitrates. Conversely, there is a lack of evidence to support the use of ranolazine in patients with CCS following PCI with incomplete revascularization.

3.3.1.2.7 Trimetazidine. Trimetazidine appears to have a haemodynamically neutral side effect profile.²⁵² Trimetazidine (35 mg b.i.d.) added to beta-blockade (atenolol) improved effort-induced myocardial ischaemia, as reviewed by the European Medicines Agency in June 2012.^{253,254} It remains contraindicated in Parkinson's disease and motion disorders, such as tremor (shaking), muscle rigidity, walking disorders, and restless leg syndrome. A 2014 meta-analysis of 13, mostly Chinese, studies consisting of 1628 patients showed that treatment with trimetazidine on top of other antianginal drugs was associated with a smaller weekly mean number of angina attacks, lower weekly

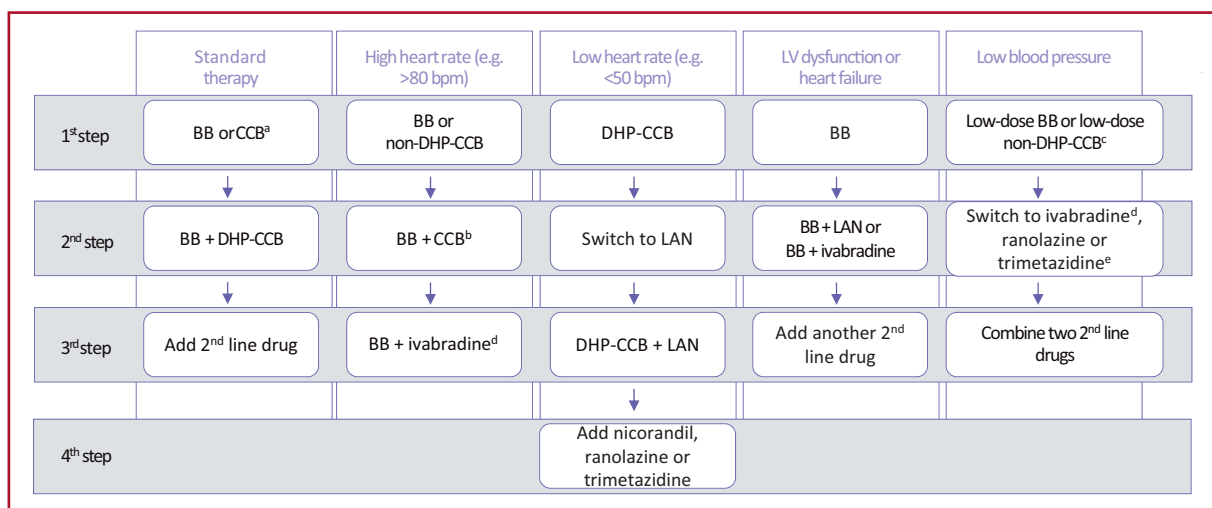

©ESC 2019

Figure 8 Suggested stepwise strategy for long term anti-ischaemic drug therapy in patients with chronic coronary syndromes and specific baseline characteristics. The proposed stepwise approach must be adapted to each patient's characteristics and preferences. Given the limited evidence on various combinations of drugs in different clinical conditions, the proposed options are only indicative of potential combinations and do not represent formal recommendations. BB = beta-blocker; bpm = beats per minute; CCB = [any class of] calcium channel blocker; DHP-CCB = dihydropyridine calcium channel blocker; HF = heart failure; LAN = long-acting nitrate; LV = left ventricular; non-DHP-CCB = non-dihydropyridine calcium channel blocker. ^aCombination of a BB with a DHP-CCB should be considered as first step; combination of a BB or a CCB with a second-line drug may be considered as a first step; ^bThe combination of a BB and non-DHP-CCB should initially use low doses of each drug under close monitoring of tolerance, particularly heart rate and blood pressure; ^cLow-dose BB or low-dose non-DHP-CCB should be used under close monitoring of tolerance, particularly heart rate and blood pressure; ^dIvabradine should not be combined with non-DHP-CCB; ^eConsider adding the drug chosen at step 2 to the drug tested at step 1 if blood pressure remains unchanged.

nitroglycerin use, longer time to 1 mm ST-segment depression, higher total work, and longer exercise duration at peak exercise than treatment with the other antianginal drugs for stable angina pectoris.²⁵⁵ These results support the use of trimetazidine as a second-line drug in patients with CCS whose symptoms are not adequately controlled by, or who are intolerant to, other medicines for angina pectoris.

3.3.1.2.8 Allopurinol. In 2010, a randomized crossover study of 65 patients with CAD showed that allopurinol 600 mg/day increased times to ST-segment depression and to angina.²⁵⁶ An observational study of 29 298 episodes of incident allopurinol use found an association of allopurinol use with a reduction in the risk of incident MI in the elderly, particularly when used for >2 years.²⁵⁷ However, the role of allopurinol in reducing clinical events in CVD remains unclear.²⁵⁸

A stepwise strategy for anti-ischaemic drug therapy in CCS is proposed, depending on some baseline patient characteristics (Figure 8). Incomplete responses or poor tolerance at each step justify moving to the next step. The strategy must be adapted to each patient's

characteristics and preferences, and does not necessarily follow the steps indicated in the figure.

3.3.1.3 Patients with low blood pressure

In patients with low BP, it is recommended to start antianginal drugs at very low doses, with preferential use of drugs with no or limited effects on BP. A low-dose beta-blocker or low-dose non-DHP-CCB can be tested first under close monitoring of tolerance. Ivabradine (in patients with sinus rhythm), ranolazine, or trimetazidine can also be used.

3.3.1.4 Patients with low heart rate

Increased heart rate correlates linearly with cardiovascular events, and the benefit of heart-rate reduction as a treatment goal in subgroups of CCS patients has been demonstrated using various drugs.^{203,259–261} However, in patients with baseline bradycardia (e.g. heart rate <60 b.p.m.) heart rate-lowering drugs (beta-blockers, ivabradine, and heart-rate lowering CCBs) should be avoided or used with caution, and—if needed—started at very low doses. Antianginal drugs without heart rate-lowering effects should preferably be given.

Recommendations on anti-ischaemic drugs in patients with chronic coronary syndromes

Recommendations	Class ^a	Level ^b
General considerations		
Medical treatment of symptomatic patients requires one or more drug(s) for angina/ischaemia relief in association with drug(s) for event prevention.	I	C
It is recommended that patients are educated about the disease, risk factors, and treatment strategy.	I	C
Timely review of the patient's response to medical therapies (e.g. 2–4 weeks after drug initiation) is recommended. ²⁶²	I	C
Angina/ischaemia^c relief		
Short-acting nitrates are recommended for immediate relief of effort angina. ^{195,263}	I	B
First-line treatment is indicated with beta-blockers and/or CCBs to control heart rate and symptoms. ^{205,264}	I	A
If angina symptoms are not successfully controlled on a beta-blocker or a CCB, the combination of a beta-blocker with a DHP-CCB should be considered.	IIa	C
Initial first-line treatment with the combination of a beta-blocker and a DHP-CCB should be considered. ^{194,198,264}	IIa	B
Long-acting nitrates should be considered as a second-line treatment option when initial therapy with a beta-blocker and/or a non-DHP-CCB is contraindicated, poorly tolerated, or inadequate to control angina symptoms. ^{200,201}	IIa	B
When long-acting nitrates are prescribed, a nitrate-free or low-nitrate interval should be considered to reduce tolerance. ²⁰¹	IIa	B
Nicorandil, ^{241–244,246} ranolazine, ^{248,265} ivabradine, ^{235–237} or trimetazidine ^{252,255} should be considered as a second-line treatment to reduce angina frequency and improve exercise tolerance in subjects who cannot tolerate, have contraindications to, or whose symptoms are not adequately controlled by beta-blockers, CCBs, and long-acting nitrates.	IIa	B
In subjects with baseline low heart rate and low BP, ranolazine or trimetazidine may be considered as a first-line drug to reduce angina frequency and improve exercise tolerance.	IIb	C
In selected patients, the combination of a beta-blocker or a CCB with second-line drugs (ranolazine, nicorandil, ivabradine, and trimetazidine) may be considered for first-line treatment according to heart rate, BP, and tolerance. ¹⁹⁸	IIb	B
Nitrates are not recommended in patients with hypertrophic obstructive cardiomyopathy ²⁶⁶ or co-administration of phosphodiesterase inhibitors. ²⁶⁷	III	B

BP = blood pressure; CCB = calcium channel blocker; CCS = chronic coronary syndromes; DHP-CCB = dihydropyridine calcium channel blocker.

^aClass of recommendation.

^bLevel of evidence.

^cNo demonstration of benefit on prognosis.

3.3.2 Event prevention

3.3.2.1 Antiplatelet drugs

Platelet activation and aggregation is the driver for symptomatic coronary thrombosis, forming the basis for the use of antiplatelet drugs in patients with CCS in view of a favourable balance between the prevention of ischaemic events and increased risk of bleeding. Dual antiplatelet therapy (DAPT) with aspirin and an oral P2Y₁₂ inhibitor is the mainstay of antithrombotic therapy after MI and/or PCI.

3.3.2.1.1 Low-dose aspirin. Aspirin acts via irreversible inhibition of platelet cyclooxygenase-1 and thus thromboxane production, which is normally complete with chronic dosing ≥ 75 mg/day. The gastrointestinal side effects of aspirin increase at higher doses, and current evidence supports a daily dose of 75–100 mg for the prevention of ischaemic events in CAD patients with or without a history of MI.^{268–270} As cyclooxygenase-1 inhibition by aspirin is consistent and predictable in adherent patients, no platelet function testing is required to monitor individual response.²⁷¹ Although other non-selective non-steroidal anti-inflammatory drugs, such as ibuprofen, reversibly inhibit cyclooxygenase-1, their adverse effects on cardiovascular risk indicate that they cannot be recommended as an alternative treatment in patients with aspirin intolerance.²⁷²

3.3.2.1.2 Oral P2Y₁₂ inhibitors. P2Y₁₂ inhibitors block the platelet P2Y₁₂ receptor, which plays a key role in platelet activation and the amplification of arterial thrombus formation. Clopidogrel and prasugrel are thienopyridine prodrugs that irreversibly block P2Y₁₂ via active metabolites. Ticagrelor is a reversibly-binding P2Y₁₂ inhibitor that does not require metabolic activation.

The CAPRIE (Clopidogrel vs. Aspirin in Patients at Risk of Ischaemic Events) trial showed an overall slight benefit of clopidogrel compared with aspirin, with a similar safety profile, in preventing cardiovascular events in patients with previous MI, previous stroke, or PAD.²⁷³ Subgroup analysis suggested greater benefit of clopidogrel in patients with PAD. Despite its lesser antiplatelet efficacy, clopidogrel demonstrated equivalent efficacy to ticagrelor in patients with PAD.²⁷⁴ Clopidogrel is limited by variable pharmacodynamic effects related to variable efficiency of conversion to its active metabolite, partly associated with loss-of-function variants in the *CYP2C19* gene, leading to a lack of efficacy in some patients.²⁷¹ Drugs that inhibit *CYP2C19*, such as omeprazole, may reduce the response to clopidogrel.²⁷⁵

Prasugrel has more rapid, more predictable, and, on average, greater antiplatelet effect compared with clopidogrel, and is not susceptible to drug interactions or the effect of *CYP2C19* loss-of-function variants. Prasugrel has greater efficacy than clopidogrel in aspirin-treated patients with ACS undergoing PCI, but not in medically-managed patients with ACS.^{276,277} Prasugrel has been associated with more non-fatal and fatal bleeding events than clopidogrel in ACS patients undergoing PCI, leading to apparent harm in those with a history of ischaemic stroke, and a lack of apparent benefit in those aged >75 years or with body weight <60 kg.²⁷⁶

Ticagrelor has the most predictable and consistently high level of P2Y₁₂ inhibition during maintenance therapy in adherent patients,²¹⁹ and also has more rapid onset, as well as more rapid and predictable offset of action compared with clopidogrel.^{278–280} Ticagrelor as monotherapy appears to have similar efficacy and safety to aspirin

monotherapy in patients with previous PCI.²⁸¹ Ticagrelor, with a 180 mg loading dose followed by 90 mg b.i.d., achieved greater reduction of ischaemic events compared with clopidogrel in aspirin-treated ACS patients, regardless of revascularization strategy, at the expense of more non-fatal bleeding.^{282,283} Ticagrelor at doses of 90 or 60 mg b.i.d. reduced the 3 year combined incidence of MI, stroke, or cardiovascular death compared with placebo in stable aspirin-treated patients with a history of MI 1–3 years previously.²⁸⁴ Both ticagrelor doses increased non-fatal but not fatal bleeding. The equivalent efficacies and similar safeties of the two ticagrelor doses were explained by similar levels of platelet inhibition.²⁸⁵ Ticagrelor may cause dyspnoea, which is often transient and most often mild and tolerable, but occasionally necessitates switching to a thienopyridine.^{286,287} Ticagrelor is metabolized via *CYP3A*, and consequently should not be used with strong *CYP3A* inhibitors or inducers.

The optimal timing of initiation of P2Y₁₂ inhibition before coronary angiography and possible PCI in patients with CCS is uncertain, but increasing use of a radial artery approach and clinical experience has allowed consideration of clopidogrel pre-treatment in patients who have a high chance of requiring PCI.²⁸⁴ Limited pharmacodynamic studies support the unlicensed use of prasugrel or ticagrelor in stable patients undergoing elective PCI who have a high risk of stent thrombosis, but the safety/efficacy balance of this approach, compared with clopidogrel, has not been established.²⁸⁸

3.3.2.1.3 Duration of dual antiplatelet therapy. After PCI for stable angina, 6 months of DAPT achieves the optimum balance of efficacy and safety in most patients.²⁸⁴ Premature discontinuation of a P2Y₁₂ inhibitor is associated with an increased risk of stent thrombosis and is discouraged.²⁸⁴ However, a shorter duration of DAPT may be considered in those at high risk of life-threatening bleeding in view of the very low risk of stent thrombosis after 1–3 months.²⁸⁴ On the basis of phase III trials, 12 months is the recommended default duration of DAPT after ACS, but shorter duration may again be considered in those at high bleeding risk.^{11,284} A DAPT study of patients undergoing PCI showed that extended therapy beyond 12 months with clopidogrel or prasugrel reduced ischaemic events and stent thrombosis, but without mortality benefit and at the expense of increased bleeding.²⁸⁹ A greater benefit of extended clopidogrel or prasugrel was seen in patients who were treated for MI.²⁹⁰

The PEGASUS-TIMI 54 (Prevention of Cardiovascular Events in Patients with Prior Heart Attack Using Ticagrelor Compared to Placebo on a Background of Aspirin–Thrombolysis In Myocardial Infarction 54) trial demonstrated that long-term therapy with ticagrelor 60 or 90 mg b.i.d., commenced in stable patients ≥ 1 year after MI, reduced ischaemic events at the expense of more non-fatal bleeding.²⁸⁴ The 60 mg dose appeared better tolerated and is approved in many countries for this indication. Subgroup analysis demonstrated greater absolute reductions in ischaemic events with long-term ticagrelor (60 mg b.i.d.) in higher-risk post-MI patients with diabetes, PAD, or multivessel CAD.^{291–293}

3.3.2.2 Anticoagulant drugs in sinus rhythm

Anticoagulant drugs inhibit the action and/or formation of thrombin, which plays a pivotal role in both coagulation and platelet activation. Consequently, anticoagulants have been shown to reduce the risk of arterial thrombotic events. The superior efficacy and safety of DAPT,

compared with aspirin and anticoagulation, in preventing stent thrombosis led to the latter strategy being abandoned in favour of DAPT following PCI.²⁸⁴ Combination of antiplatelet therapy and standard anticoagulant doses of warfarin or apixaban for secondary prevention after ACS was associated with an unfavourable balance of efficacy and bleeding.^{294,295} However, recently reported studies have renewed interest in combining lower anticoagulant doses with antiplatelet therapy.

3.3.2.2.1 Low-dose rivaroxaban. Rivaroxaban is a factor Xa inhibitor that has been studied at a low dose of 2.5 mg b.i.d. in several populations of patients in sinus rhythm, this dose being one-quarter of the standard dose used for anticoagulation in patients with AF. Rivaroxaban 2.5 mg b.i.d., compared with placebo, reduced the composite of MI, stroke, or cardiovascular death in stabilized patients treated predominantly with aspirin and clopidogrel following ACS, at the expense of increased bleeding but with evidence of a reduction in cardiovascular death.²⁹⁶ Subsequently, in the COMPASS (Cardiovascular Outcomes for People Using Anticoagulation Strategies) trial, the same regimen in combination with aspirin was compared with aspirin alone, as well as rivaroxaban 5 mg b.i.d. alone, in patients with CCS or PAD, and showed reduced ischaemic events at the expense of increased risk of predominantly non-fatal bleeding.²⁹⁷ Of note, the pre-specified significance thresholds for cardiovascular mortality and all-cause mortality were not met. Greater absolute risk reductions were seen in higher-risk patients with diabetes, PAD, or moderate chronic kidney disease (CKD), as well as current smokers. In GEMINI-ACS (A Study to Compare the Safety of Rivaroxaban Versus Acetylsalicylic Acid in Addition to Either Clopidogrel or Ticagrelor Therapy in Participants With Acute Coronary Syndrome), rivaroxaban 2.5 mg b.i.d. was compared with aspirin in patients treated with a P2Y₁₂ inhibitor who were stable following PCI. The results suggested similar safety of rivaroxaban to aspirin in this setting, but larger studies are required to substantiate this finding.²⁹⁸ In addition, the safety of performing PCI without aspirin pre-treatment is unknown.

3.3.2.3 Anticoagulant drugs in atrial fibrillation

Anticoagulant therapy is recommended in patients with AF and CCS for reduction of ischaemic stroke and other ischaemic events. Anticoagulants in AF patients have demonstrated superiority over aspirin monotherapy or clopidogrel-based DAPT for stroke prevention, and are therefore recommended for this indication.²⁹⁹ When oral anticoagulation is initiated in a patient with AF who is eligible for a non-vitamin K antagonist oral anticoagulant (NOAC; apixaban, dabigatran, edoxaban, or rivaroxaban), a NOAC is recommended in preference to a vitamin K antagonist (VKA).²⁹⁹

3.3.2.3.1 Combination anticoagulant and antiplatelet therapy following percutaneous coronary intervention for patients with atrial fibrillation or another indication for oral anticoagulation. No studies to date have specifically focused on CCS patients with AF undergoing PCI and clinical decisions must be based on clinical trials that have included a large proportion of patients with ACS. For peri-procedural management, it is recommended that interruption of VKA is avoided, if feasible, whereas it is recommended that NOAC therapy is stopped for 12–48 h before elective PCI, depending on renal function and the

particular NOAC regimen.³⁰⁰ Radial artery access is preferred along with intraprocedural unfractionated heparin either at a standard dose (70–100 U/kg) or, in those with uninterrupted VKA, at a lower dose of 30–50 U/kg.³⁰⁰ Pre-treatment with aspirin 75–100 mg daily is recommended, and clopidogrel (300–600 mg loading dose if not on long-term maintenance therapy) is recommended in preference to prasugrel or ticagrelor.³⁰⁰ VKA-treated patients receiving aspirin and clopidogrel post-PCI should have a target international normalized ratio in the range of 2.0–2.5, aiming for high time in therapeutic range (>70%).³⁰⁰ Subsequent to post-PCI trials of different antithrombotic regimens considered in previous Guidelines,^{88,284} the AUGUSTUS trial (An Open-label, 2 × 2 Factorial, Randomized Controlled, Clinical Trial to Evaluate the Safety of Apixaban vs. Vitamin K Antagonist and Aspirin vs. Aspirin Placebo in Patients With Atrial Fibrillation and Acute Coronary Syndrome or Percutaneous Coronary Intervention) showed, firstly, that apixaban 5 mg b.i.d. (i.e. the licensed dose for thromboprophylaxis in AF) was associated with significantly less major or clinically relevant non-major bleeding than VKA; and, secondly, that aspirin, compared with placebo, was associated with significantly more bleeding, with the safest combination being apixaban and placebo in addition to P2Y₁₂ inhibitor (predominantly clopidogrel).³⁰¹ However, there were numerically, but not statistically significantly, more stent thrombosis events with placebo than with aspirin, and the trial was not powered to assess differences in these events between groups.³⁰¹ Consequently, when concerns about thrombotic risk prevail over concerns about bleeding risk, ≥1 month of triple therapy [oral anticoagulant (OAC), aspirin, and clopidogrel] is recommended to cover the period when the risk of stent thrombosis is presumed to exceed the risk of bleeding.^{300,301} There is currently limited evidence to support the use of OACs with ticagrelor or prasugrel as dual therapy after PCI as an alternative to triple therapy.^{300,301}

3.3.2.3.2 Long-term combination therapy in patients with atrial fibrillation or another indication for anticoagulation. OAC monotherapy is generally recommended 6–12 months after PCI in patients with AF, as there is a lack of specific data supporting long-term treatment with an OAC and a single antiplatelet agent; however, in highly selected cases with high ischaemic risk, dual therapy with an OAC and aspirin or clopidogrel may be considered.³⁰⁰

3.3.2.4 Proton pump inhibitors

Proton pump inhibitors reduce the risk of gastrointestinal bleeding in patients treated with antiplatelet drugs and may be a useful adjunctive treatment for improving safety.²⁷⁵ Long-term proton pump inhibitor use is associated with hypomagnesaemia, but the role of monitoring serum magnesium levels is uncertain. Proton pump inhibitors that inhibit CYP2C19, particularly omeprazole and esomeprazole, may reduce the pharmacodynamic response to clopidogrel. Although this has not been shown to affect the risk of ischaemic events or stent thrombosis, co-administration of omeprazole or esomeprazole with clopidogrel is generally not recommended.

3.3.2.5 Cardiac surgery and antithrombotic therapy

Aspirin should normally be continued in patients with CCS undergoing elective cardiac surgery, and other antithrombotic drugs stopped at intervals according to their duration of action and

indication (prasugrel stopped ≥ 7 days before; clopidogrel ≥ 5 days before; ticagrelor ≥ 3 days before; and rivaroxaban, apixaban, edoxaban, and dabigatran 1–2 days before depending on dose and renal function). Reloading of aspirin after CABG surgery may improve graft patency.³⁰² The role of DAPT or dual therapy with aspirin and rivaroxaban after CABG surgery is uncertain as large prospective studies are lacking. However, RCT results have suggested higher graft patency rates with DAPT compared with aspirin monotherapy.^{284,303,304}

3.3.2.6 Non-cardiac surgery and antithrombotic therapy

Non-cardiac surgery is associated with an increased risk of MI. Following PCI, whenever possible, it is recommended to postpone elective surgery until the recommended course of DAPT has been

completed. Usually, this will mean delaying surgery until 6 months after PCI, but surgery between 3–6 months may be considered by a multidisciplinary team, including an interventional cardiologist, if clinically indicated. In most types of surgery, aspirin should be continued as the benefit outweighs the bleeding risk, but this may not be appropriate for procedures associated with extremely high bleeding risk (intracranial procedures, transurethral prostatectomy, intraocular procedures, etc.).²⁸⁴ The COMPASS study included CCS patients with a history of peripheral revascularization procedures, and demonstrated benefits of aspirin and rivaroxaban 2.5 mg b.i.d. compared with aspirin alone, including reductions in major adverse limb events and mortality, suggesting the need to risk-stratify patients after non-cardiac vascular surgery for atherosclerotic disease.^{305,306}

Recommendations for event prevention I

Recommendations	Class ^a	Level ^b
Antithrombotic therapy in patients with CCS and in sinus rhythm		
Aspirin 75–100 mg daily is recommended in patients with a previous MI or revascularization. ²⁷⁰	I	A
Clopidogrel 75 mg daily is recommended as an alternative to aspirin in patients with aspirin intolerance. ²⁷³	I	B
Clopidogrel 75 mg daily may be considered in preference to aspirin in symptomatic or asymptomatic patients, with either PAD or a history of ischaemic stroke or transient ischaemic attack. ²⁷³	IIb	B
Aspirin 75–100 mg daily may be considered in patients without a history of MI or revascularization, but with definitive evidence of CAD on imaging.	IIb	C
Adding a second antithrombotic drug to aspirin for long-term secondary prevention should be considered in patients with a high risk of ischaemic events ^c and without high bleeding risk ^d (see Table 9 for options). ^{289,296,297,307}	IIa	A
Adding a second antithrombotic drug to aspirin for long-term secondary prevention may be considered in patients with at least a moderately increased risk of ischaemic events ^e and without high bleeding risk ^d (see Table 9 for options). ^{289,296,297,307}	IIb	A
Antithrombotic therapy post-PCI in patients with CCS and in sinus rhythm		
Aspirin 75–100 mg daily is recommended following stenting. ²⁸⁴	I	A
Clopidogrel 75 mg daily following appropriate loading (e.g. 600 mg or >5 days of maintenance therapy) is recommended, in addition to aspirin, for 6 months following coronary stenting, irrespective of stent type, unless a shorter duration (1–3 months) is indicated due to risk or the occurrence of life-threatening bleeding. ²⁸⁴	I	A
Clopidogrel 75 mg daily following appropriate loading (e.g. 600 mg or >5 days of maintenance therapy) should be considered for 3 months in patients with a higher risk of life-threatening bleeding. ²⁸⁴	IIa	A
Clopidogrel 75 mg daily following appropriate loading (e.g. 600 mg or >5 days of maintenance therapy) may be considered for 1 month in patients with very high risk of life-threatening bleeding. ²⁸⁴	IIb	C
Prasugrel or ticagrelor may be considered, at least as initial therapy, in specific high-risk situations of elective stenting (e.g. suboptimal stent deployment or other procedural characteristics associated with high risk of stent thrombosis, complex left main stem, or multivessel stenting) or if DAPT cannot be used because of aspirin intolerance.	IIb	C
Antithrombotic therapy in patients with CCS and AF		
When oral anticoagulation is initiated in a patient with AF who is eligible for a NOAC, ^f a NOAC is recommended in preference to a VKA. ^{299–301,308–311}	I	A
Long-term OAC therapy (NOAC or VKA with time in therapeutic range >70%) is recommended in patients with AF and a CHA ₂ DS ₂ -VASc score ^g ≥ 2 in males and ≥ 3 in females. ²⁹⁹	I	A

Continued

Long-term OAC therapy (NOAC or VKA with time in therapeutic range >70%) should be considered in patients with AF and a CHA ₂ DS ₂ -VASc score ^g of 1 in males and 2 in females. ²⁹⁹	IIa	B
Aspirin 75–100 mg daily (or clopidogrel 75 mg daily) may be considered in addition to long-term OAC therapy in patients with AF, history of MI, and at high risk of recurrent ischaemic events ^c who do not have a high bleeding risk. ^{d 295,297,299}	IIb	B
Antithrombotic therapy in post-PCI patients with AF or another indication for an OAC		
It is recommended that peri-procedural aspirin and clopidogrel are administered to patients undergoing coronary stent implantation.	I	C
In patients who are eligible for a NOAC, it is recommended that a NOAC (apixaban 5 mg b.i.d., dabigatran 150 mg b.i.d., edoxaban 60 mg o.d., or rivaroxaban 20 mg o.d.) ^f is used in preference to a VKA in combination with antiplatelet therapy. ^{300,301,308,310,311}	I	A
When rivaroxaban is used and concerns about high bleeding risk ^d prevail over concerns about stent thrombosis ^h or ischaemic stroke, ^g rivaroxaban 15 mg o.d. should be considered in preference to rivaroxaban 20 mg o.d. for the duration of concomitant single or dual antiplatelet therapy. ^{300,301,308,310}	IIa	B
When dabigatran is used and concerns about high bleeding risk ^d prevail over concerns about stent thrombosis ^h or ischaemic stroke, ^g dabigatran 110 mg b.i.d. should be considered in preference to dabigatran 150 mg b.i.d. for the duration of concomitant single or dual antiplatelet therapy. ^{300,301,308}	IIa	B
After uncomplicated PCI, early cessation (≤1 week) of aspirin and continuation of dual therapy with an OAC and clopidogrel should be considered if the risk of stent thrombosis ^h is low, or if concerns about bleeding risk prevail over concerns about the risk of stent thrombosis, ^h irrespective of the type of stent used. ^{301,308–310}	IIa	B
Triple therapy with aspirin, clopidogrel, and an OAC for ≥1 month should be considered when the risk of stent thrombosis ^h outweighs the bleeding risk, with the total duration (≤6 months) decided according to assessment of these risks and clearly specified at hospital discharge.	IIa	C
In patients with an indication for a VKA in combination with aspirin and/or clopidogrel, the dose intensity of the VKA should be carefully regulated with a target international normalized ratio in the range of 2.0–2.5 and with time in therapeutic range >70%. ^{300,301,308–310}	IIa	B
Dual therapy with an OAC and either ticagrelor or prasugrel may be considered as an alternative to triple therapy with an OAC, aspirin, and clopidogrel in patients with a moderate or high risk of stent thrombosis, ^h irrespective of the type of stent used.	IIb	C
The use of ticagrelor or prasugrel is not recommended as part of triple antithrombotic therapy with aspirin and an OAC.	III	C
Use of proton pump inhibitors		
Concomitant use of a proton pump inhibitor is recommended in patients receiving aspirin monotherapy, DAPT, or OAC monotherapy who are at high risk of gastrointestinal bleeding. ²⁸⁴	I	A

AF = atrial fibrillation; b.i.d. = bis in die (twice a day); CAD = coronary artery disease; CCS = chronic coronary syndromes; CHA₂DS₂-VASc = Cardiac failure, Hypertension, Age ≥75 [Doubled], Diabetes, Stroke [Doubled] – Vascular disease, Age 65–74 and Sex category [Female]; CKD = chronic kidney disease; DAPT = dual antiplatelet therapy; eGFR = estimated glomerular filtration rate; HF = heart failure; MI = myocardial infarction; NOAC = non-vitamin K antagonist oral anticoagulant; OAC = oral anticoagulant; o.d. = omni die (once a day); PAD = peripheral artery disease; PCI = percutaneous coronary intervention; VKA = vitamin K antagonist.

^aClass of recommendation.

^bLevel of evidence.

^cDiffuse multivessel CAD with at least one of the following: diabetes mellitus requiring medication, recurrent MI, PAD, or CKD with eGFR 15–59 mL/min/1.73 m².

^dPrior history of intracerebral haemorrhage or ischaemic stroke, history of other intracranial pathology, recent gastrointestinal bleeding or anaemia due to possible gastrointestinal blood loss, other gastrointestinal pathology associated with increased bleeding risk, liver failure, bleeding diathesis or coagulopathy, extreme old age or frailty, or renal failure requiring dialysis or with eGFR <15 mL/min/1.73 m².

^eAt least one of the following: multivessel/diffuse CAD, diabetes mellitus requiring medication, recurrent MI, PAD, HF, or CKD with eGFR 15–59 mL/min/1.73 m².

^fSee summary of product characteristics for reduced doses or contraindications for each NOAC in patients with CKD, body weight <60 kg, age >75–80 years, and/or drug interactions.

^gCongestive HF, hypertension, age ≥75 years (2 points), diabetes, prior stroke/transient ischaemic attack/embolus (2 points), vascular disease (CAD on imaging or angiography,³¹² prior MI, PAD, or aortic plaque), age 65–74 years, and female sex.

^hRisk of stent thrombosis encompasses (i) the risk of thrombosis occurring and (ii) the risk of death should stent thrombosis occur, both of which relate to anatomical, procedural, and clinical characteristics. Risk factors for CCS patients include stenting of left main stem, proximal LAD, or last remaining patent artery; suboptimal stent deployment; stent length >60 mm; diabetes mellitus; CKD; bifurcation with two stents implanted; treatment of chronic total occlusion; and previous stent thrombosis on adequate antithrombotic therapy.

Table 9 Treatment options for dual antithrombotic therapy in combination with aspirin 75 – 100 mg daily in patients who have a high^a or moderate^b risk of ischaemic events, and do not have a high bleeding risk^c

Drug option	Dose	Indication	Additional cautions	References
Clopidogrel	75 mg o.d.	Post-MI in patients who have tolerated DAPT for 1 year		289,290
Prasugrel	10 mg o.d. or 5 mg o.d.; if body weight <60 kg or age >75 years	Post-PCI for MI in patients who have tolerated DAPT for 1 year	Age >75 years	289,290,313
Rivaroxaban	2.5 mg b.i.d.	Post-MI >1 year or multivessel CAD	Creatinine clearance 15 - 29 mL/min	297
Ticagrelor	60 mg b.i.d.	Post-MI in patients who have tolerated DAPT for 1 year		291–293,307,314

Treatment options are presented in alphabetical order.

b.i.d. = bis in die (twice a day); CAD = coronary artery disease; CKD = chronic kidney disease; DAPT = dual antiplatelet therapy; eGFR = estimated glomerular filtration rate; HF = heart failure; MI = myocardial infarction; o.d. = omni die (once a day); PAD = peripheral artery disease; PCI = percutaneous coronary intervention.

^aHigh risk of ischaemic events is defined as diffuse multivessel CAD with at least one of the following: diabetes mellitus requiring medication, recurrent MI, PAD, or CKD with eGFR 15 - 59 mL/min/1.73 m².

^bModerately increased risk of ischaemic events is defined as at least one of the following: multivessel/diffuse CAD, diabetes mellitus requiring medication, recurrent MI, PAD, HF, or CKD with eGFR 15 - 59 mL/min/1.73 m².

^cHigh bleeding risk is defined as history of intracerebral haemorrhage or ischaemic stroke, history of other intracranial pathology, recent gastrointestinal bleeding or anaemia due to possible gastrointestinal blood loss, other gastrointestinal pathology associated with increased bleeding risk, liver failure, bleeding diathesis or coagulopathy, extreme old age or frailty, or renal failure requiring dialysis or with eGFR <15 mL/min/1.73 m².

3.3.3 Statins and other lipid-lowering drugs

Dyslipidaemia should be managed according to lipid guidelines with pharmacological and lifestyle intervention.³¹⁵ Patients with established CAD are regarded as being at very high risk for cardiovascular events and statin treatment must be considered, irrespective of LDL-C levels. The goal of treatment is to lower LDL-C by at least 50% from baseline and to <1.4 mmol/L (<55 mg/dL) although a lower target LDL-C of <1.0 mmol/L (<40 mg/dL) may be considered in patients who have experienced a second vascular event within 2 years, not necessarily of the same type as the first event, whilst taking maximally tolerated statin-based therapy. When this level cannot be achieved, the addition of ezetimibe has been demonstrated to decrease cholesterol and cardiovascular events in post-ACS patients, and in those with diabetes,³¹⁶ with no further effect on mortality.³¹⁷ In addition to exercise, diet, and weight control, which should be recommended to all patients, dietary supplements including phytosterols may lower LDL-C to a lesser extent, but have not been shown to improve clinical outcomes.³¹⁸ These are also used in patients with intolerance to statins who constitute a group at higher risk for cardiovascular events.³¹⁹ Trials published since 2015 have demonstrated that proprotein convertase subtilisin-kexin type 9 (PCSK9) inhibitors (evolocumab³²⁰ and alirocumab^{321–323}) are very effective at reducing cholesterol, lowering LDL-C in a stable fashion to ≤1.3 mmol/L (50 mg/dL). In outcomes trials, these agents have demonstrated a reduction of cardiovascular and mainly ischaemic events, with little or no impact on mortality.³²⁴ Very low levels of cholesterol are well tolerated and associated with fewer events,³²⁵ but the high cost of PCSK9 inhibitors, unaffordable for many health systems,³²⁶ and their unknown long-term safety have limited their use to date. Low-density lipoprotein apheresis and new therapies such as mipomersen and lomitapide need further research.

For patients undergoing PCI, high-dose atorvastatin has been shown to reduce the frequency of peri-procedural events in both statin-naïve patients and patients receiving chronic statin therapy.³²⁷

3.3.4 Reninangiotensinaldosterone system blockers

ACE inhibitors can reduce mortality, MI, stroke, and HF among patients with LV dysfunction,^{328–330} previous vascular disease,^{331–333} and high-risk diabetes.³³⁴ It is recommended that ACE inhibitors [or angiotensin receptor blockers (ARBs) in cases of intolerance] be considered for the treatment of patients with CCS with coexisting hypertension, LVEF ≤40%, diabetes, or CKD, unless contraindicated (e.g. severe renal impairment, hyperkalaemia, etc.). However, not all trials have demonstrated that ACE inhibitors reduce all-cause death, cardiovascular death, non-fatal MI, stroke, or HF in patients with atherosclerosis and without impaired LV function.^{331,332,335} A meta-analysis, including 24 trials and 61 961 patients, documented that, in CCS patients without HF, renin-angiotensin system (RAS) inhibitors reduced cardiovascular events and death only when compared with placebo, but not when compared with active controls.³³⁶ Hence, ACE inhibitor therapy in CCS patients without HF or high cardiovascular risk is not generally recommended, unless required to meet BP targets.

Neprilysin is an endogenous enzyme that degrades vasoactive peptides such as bradykinin and natriuretic peptides. Pharmacological inhibition of neprilysin raises the levels of these peptides, enhancing diuresis, natriuresis, myocardial relaxation, and antiremodelling, and reducing renin and aldosterone secretion. The first in class is LCZ696, which combines valsartan and sacubitril (neprilysin inhibitor) in a single pill. In patients with HF (LVEF ≤35%) who remain symptomatic despite optimal treatment with an ACE inhibitor, a beta-blocker, and a mineralocorticoid receptor antagonist (MRA), sacubitril/valsartan is recommended as a replacement for an ACE inhibitor to further reduce the risk of HF hospitalization and death in ambulatory patients.³³⁷

Aldosterone blockade with spironolactone or eplerenone is recommended for use in post-MI patients who are already receiving therapeutic doses of an ACE inhibitor and a beta-blocker, have an LVEF ≤35%, and have either diabetes or HF.^{338,339} Caution should be exercised when MRAs are used in patients with impaired renal function [estimated GFR (eGFR) <45 mL/min/1.73 m²] and in those with serum potassium levels ≥5.0 mmol/L.³⁴⁰

Recommendations for event prevention II

Lipid-lowering drugs	Class ^a	Level ^b
Statins are recommended in all patients with CCS. ^{c 341,342}	I	A
If a patient's goal ^c is not achieved with the maximum tolerated dose of statin, combination with ezetimibe is recommended. ^{317,320}	I	B
For patients at very high risk who do not achieve their goal ^c on a maximum tolerated dose of statin and ezetimibe, combination with a PCSK9 inhibitor is recommended. ^{320,323}	I	A
ACE inhibitors		
ACE inhibitors (or ARBs) are recommended if a patient has other conditions (e.g. heart failure, hypertension, or diabetes). ^{328–330}	I	A
ACE inhibitors should be considered in CCS patients at very high risk of cardiovascular events. ^{331,332,335,336}	IIa	A
Other drugs		
Beta-blockers are recommended in patients with LV dysfunction or systolic HF. ^{211,212,214}	I	A
In patients with a previous STEMI, long-term oral treatment with a beta-blocker should be considered. ^{213,220–222,225,343}	IIa	B

ACE = angiotensin-converting enzyme; ARB = angiotensin-receptor blocker; CCS = chronic coronary syndrome; HF = heart failure; LV = left ventricular; PCSK9 = proprotein convertase subtilisin-kexin type 9; STEMI = ST-elevation myocardial infarction.

^aClass of recommendation.

^bLevel of evidence.

^cThe treatment goals are shown in the European Society of Cardiology/European Atherosclerosis Society Guidelines for the management of dyslipidaemias.³¹⁵

3.3.5 Hormone replacement therapy

The results from large randomized trials have shown that hormone replacement therapy provides no prognostic benefit and increases the risk of CVD in women aged >60 years.³⁴⁴

3.4 Revascularization

In patients with CCS, optimal medical therapy is key for reducing symptoms, halting the progression of atherosclerosis, and preventing atherothrombotic events. Myocardial revascularization plays a central role in the management of CCS on top of medical treatment, but always as an adjunct to medical therapy without supplanting it. The two objectives of revascularization are symptom relief in patients with angina and/or improvement of prognosis.

Previous Guidelines support indications for revascularization mainly in patients with CCS who receive Guideline-recommended optimal medical therapy and continue to be symptomatic, and/or in whom revascularization may ameliorate prognosis.⁸⁸ These recommendations suggested that revascularization in patients with angina and significant stenosis was often a second-line therapy after medical therapy had been unsuccessful. However, angina is associated with impaired quality of life, reduced physical endurance, mental depression, and recurrent hospitalizations and office visits, with impaired clinical outcomes.^{345,346}

Revascularization by PCI or CABG may effectively relieve angina, reduce the use of antianginal drugs, and improve exercise capacity and quality of life compared with a strategy of medical therapy alone. In the 5 year follow-up of the FAME 2 (Fractional Flow Reserve versus Angiography for Multivessel Evaluation 2) trial, revascularization improved quality of life, and reduced the use of antianginal drugs and associated side effects.³⁴⁷ The ORBITA (Objective Randomised Blinded Investigation with optimal medical Therapy or Angioplasty in stable angina) study, entailing a sham procedure in the control group, found no significant improvement in exercise capacity

with PCI.²⁶² The study highlights a significant placebo component to the clinical effects, and alerts us to the pitfalls of interpreting endpoints subject to bias in the absence of sham control and blinding. However, the ORBITA results cannot inform Guidelines due to the limited trial size, short-term observation time until crossover, and insufficient power to assess clinical endpoints.

Revascularization by either PCI or CABG also aims to effectively eliminate myocardial ischaemia and its adverse clinical manifestations among patients with significant coronary stenosis, and to reduce the risk of major acute cardiovascular events including MI and cardiovascular death. Numerous meta-analyses comparing a strategy of PCI with initial medical therapy among patients with CCS have found no^{348,349} or a modest^{104,350,351} benefit, in terms of survival or MI for an invasive strategy. In this regard, previous Guidelines identified specific subgroups of patients (based on the anatomy of the coronary tree, LV function, risk factors, etc.) in whom revascularization may improve prognosis, indicating that in other groups it may not.⁸⁸

A meta-analysis by Windecker *et al.* reported an incremental reduction of death and MI by revascularization vs. medical therapy only in CCS patients when revascularization was performed with CABG or new-generation drug-eluting stents (DES), as opposed to balloon angioplasty, bare-metal stents, or early DES.³⁵¹ Data reported in 2018 indicate a potentially broader prognostic impact of revascularization strategies. The 5 year follow-up of the FAME 2 trial confirmed a sustained clinical benefit in patients treated with PCI specifically targeting the ischaemia-producing stenoses (i.e. FFR <0.80) plus optimal medical therapy vs. optimal medical therapy alone in terms of a significantly lower rate of urgent revascularization (hazard ratio 0.27, 95% CI 0.18–0.41), and a lower rate of spontaneous MI (hazard ratio 0.62, 95% CI 0.39–0.99).³⁴⁷ In contrast to some of the earlier meta-analyses, this signal was confirmed in a patient-level meta-analysis including 2400 subjects, all of whom underwent invasive physiological guidance, showing a significant reduction in cardiac death and MI after a median follow-up of 33 months with FFR-guided

PCI vs. medical therapy (hazard ratio 0.74, 95% CI 0.56–0.989; $P=0.041$).³⁵² Together, these new data support a less restrictive indication for revascularization in CCS, in addition to specific anatomy [e.g. left main (LM)] or extended ischaemia (>10%), when PCI is restricted to angiographic stenoses on large vessels causing a significant intracoronary pressure gradient. Figure 9 summarizes a practical approach to the indications of revascularization in CCS according to the presence or absence of symptoms, and documentation of non-invasive ischaemia. However, the individual risk-benefit ratio should always be evaluated and revascularization considered only if its expected benefit outweighs its potential risk. Also, the aspect of shared decision-making is key, with full information given to the patient about the anticipated advantages and disadvantages of the

two strategies, including the DAPT-related bleeding risks in cases of revascularization by PCI. For the discussion of the best choice between revascularization modalities—PCI or CABG—for individual patients, we refer readers to the 2018 ESC myocardial revascularization Guidelines.⁸⁸

4 Patients with new onset of heart failure or reduced left ventricular function

CAD is the most common cause of HF in Europe, and most of the trial evidence supporting management recommendations is based on

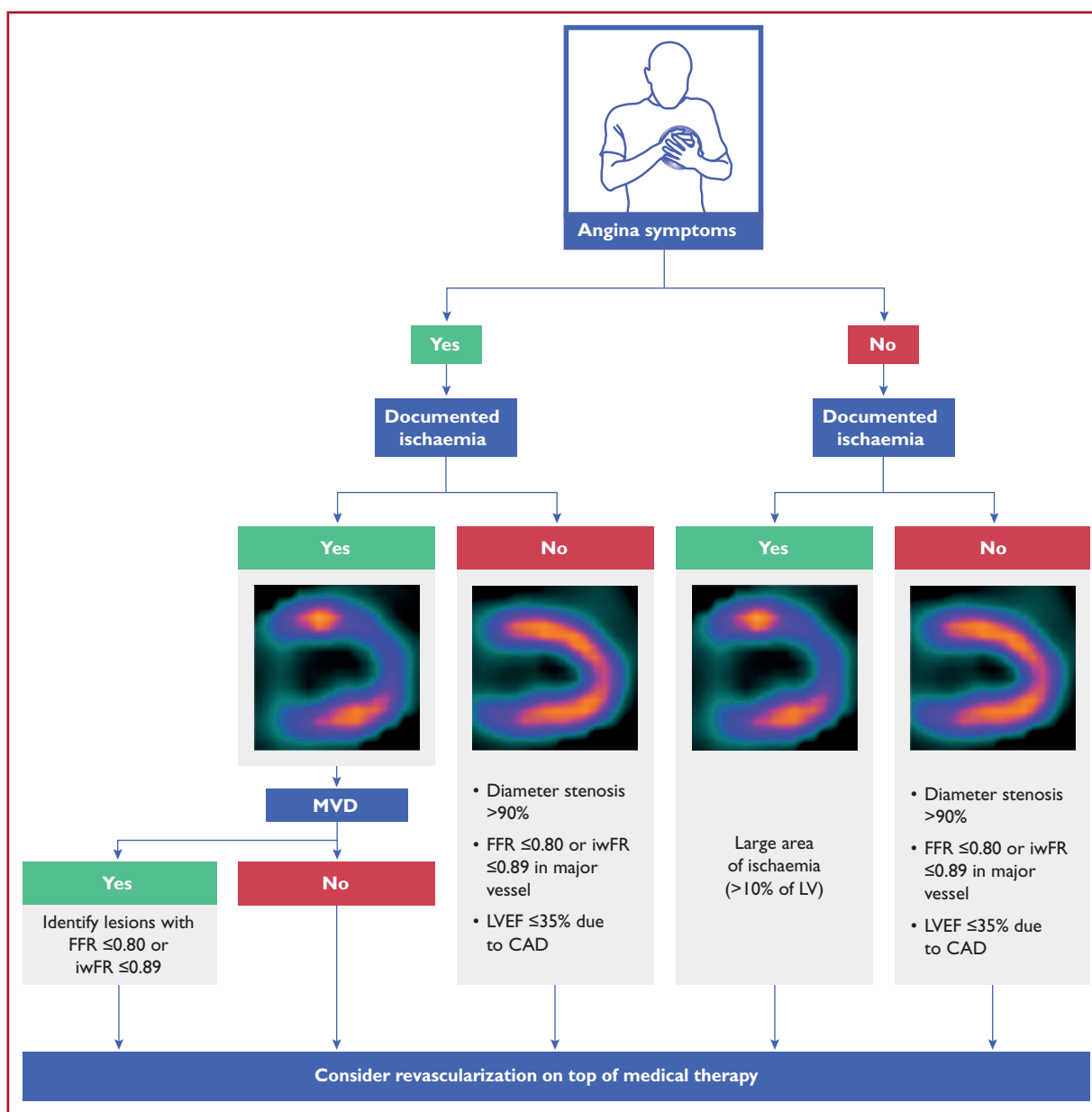

Figure 9 Decision tree for patients undergoing invasive coronary angiography. Decisions for revascularization by percutaneous coronary intervention or coronary artery bypass grafting are based on clinical presentation (symptoms present or absent), and prior documentation of ischaemia (present or absent). In the absence of prior documentation of ischaemia, indications for revascularization depend on invasive evaluation of stenosis severity or prognostic indications. Patients with no symptoms and ischaemia include candidates for transcatheter aortic valve implantation, valve, and other surgery. CAD = coronary artery disease; FFR = fractional flow reserve; iwFR = instantaneous wave-free ratio; LV = left ventricle; LVEF = left ventricular ejection fraction; MVD = multivessel disease.

research conducted in patients with ischaemic cardiomyopathy. The pathophysiology results in systolic dysfunction due to myocardial injury and ischaemia, and most patients with symptomatic HF have reduced ejection fraction (<40%), although patients with CCS may also have symptomatic HF and a preserved ejection fraction ($\geq 50\%$). Patients with symptomatic HF should be managed clinically according to the 2016 ESC heart failure Guidelines.³⁴⁰

History should include the assessment of symptoms suggestive of HF, especially exercise intolerance and dyspnoea on exertion. All major past events related to CAD including MI and revascularization procedures are recorded, as well as all major cardiovascular comorbidity requiring treatment such as AF, hypertension, or valvular dysfunction, and non-cardiovascular comorbidity such as CKD, diabetes, anaemia, or cancer. Current medical therapy, adherence, and tolerance should be reviewed.

Physical examination should assess the nutritional status of patients, and estimate biological age and cognitive ability. Recorded physical signs include heart rate, heart rhythm, supine BP, murmurs suggestive of aortic stenosis or mitral insufficiency, signs of pulmonary congestion with basal rales or pleural effusion, signs of systemic congestion with dependant oedema, hepatomegaly, and elevated jugular venous pressure.

A *routine ECG* provides information on heart rate and rhythm, extrasystole, signs of ischaemia, pathological Q waves, hypertrophy, conduction abnormalities, and bundle branch block.

Imaging should include an echocardiographic examination with Doppler to evaluate evidence of ischaemic cardiomyopathy with HF with reduced ejection fraction, HF with mid-range ejection fraction, or HF with preserved ejection fraction, focal/diffuse LV or right ventricular systolic dysfunction, evidence of diastolic dysfunction, hypertrophy, chamber volumes, valvular function, and evidence of pulmonary hypertension. Chest X-ray can detect signs of pulmonary congestion, interstitial oedema, infiltration, or pleural effusion. If not known, coronary angiography (or coronary CTA) should be

performed to establish the presence and extent of CAD, and evaluate the potential for revascularization.^{52,53}

Laboratory investigations should measure natriuretic peptide levels to rule-out the diagnosis of suspected HF. When present, the severity of HF can be assessed.^{25,49} Renal function along with serum electrolytes should be measured routinely to detect the development of renal insufficiency, hyponatraemia, or hyperkalaemia, especially at the initiation and during up-titration of pharmacological therapy.

The *management* of patients with symptomatic HF requires adequate diuretic therapy, preferably with a loop diuretic, to relieve signs and symptoms of pulmonary and systemic congestion. Inhibitors of both the RAS system (ACE inhibitors, ARBs, angiotensin receptor-neprilysin inhibitor) and the adrenergic nervous system (beta-blockers) are indicated in all symptomatic patients with HF.³⁴⁰ In patients with persistent symptoms, an MRA is also indicated. Up-titration of these drugs should be gradual to avoid symptomatic systolic hypotension, renal insufficiency, or hyperkalaemia.

Patients who remain symptomatic, with LV systolic dysfunction and evidence of ventricular dysrhythmia or bundle branch block, may be eligible for a device [cardiac resynchronization therapy (CRT)/implantable cardioverter-defibrillator]. Such devices may provide symptomatic relief, reduce morbidity, and improve survival.^{353–356} Patients with HF may decompensate rapidly following the onset of atrial or ventricular dysrhythmia, and should be treated according to current Guidelines. Patients with HF, and haemodynamically significant aortic stenosis or mitral insufficiency, may require percutaneous or surgical intervention.

Myocardial revascularization should be considered in eligible patients with HF based on their symptoms, coronary anatomy, and risk profile. Successful revascularization in patients with HF due to ischaemic cardiomyopathy may improve LV dysfunction and prognosis by reducing ischaemia to viable, hibernating myocardium. If available, cooperation with a multidisciplinary HF team is strongly advised.^{348,357,358}

General recommendations for the management of patients with chronic coronary syndromes and symptomatic heart failure due to ischaemic cardiomyopathy and left ventricular systolic dysfunction

Recommendations for drug therapy	Class ^a	Level ^b
Diuretic therapy is recommended in symptomatic patients with signs of pulmonary or systemic congestion to relieve HF symptoms. ^{359,360}	I	B
Beta-blockers are recommended as essential components of treatment due to their efficacy in both relieving angina, and reducing morbidity and mortality in HF. ^{214,361–367}	I	A
ACE inhibitor therapy is recommended in patients with symptomatic HF or asymptomatic LV dysfunction following MI, to improve symptoms and reduce morbidity and mortality. ^{333,368}	I	A
An ARB is recommended as an alternative in patients who do not tolerate ACE inhibition, or an angiotensin receptor-neprilysin inhibitor in patients with persistent symptoms despite optimal medical therapy. ^{337,369}	I	B
An MRA is recommended in patients who remain symptomatic despite adequate treatment with an ACE inhibitor and beta-blocker, to reduce morbidity and mortality. ^{360,370}	I	A
A short-acting oral or transcutaneous nitrate should be considered (effective antianginal treatment, safe in HF). ³⁷¹	IIa	A
Ivabradine should be considered in patients with sinus rhythm, an LVEF $\leq 35\%$ and a resting heart rate >70 b.p.m. who remain symptomatic despite adequate treatment with a beta-blocker, ACE inhibitor, and MRA, to reduce morbidity and mortality. ^{238,372,373}	IIa	B
Amlodipine may be considered for relief of angina in patients with HF who do not tolerate beta-blockers, and is considered safe in HF. ^{374,375}	IIb	B

Continued

For devices, comorbidities, and revascularization		
In patients with HF and bradycardia with high-degree atrioventricular block who require pacing, a CRT with a pacemaker rather than right ventricular pacing is recommended. ³⁵³	I	A
An implantable cardioverter-defibrillator is recommended in patients with documented ventricular dysrhythmia causing haemodynamic instability (secondary prevention), as well as in patients with symptomatic HF and an LVEF ≤35%, to reduce the risk of sudden death and all-cause mortality. ^{354,376–382}	I	A
CRT is recommended for symptomatic patients with HF in sinus rhythm with a QRS duration ≥150 ms and LBBB QRS morphology, and with LVEF ≤35%, despite optimal medical therapy to improve symptoms, and reduce morbidity and mortality. ^{355,356,383–392}	I	A
CRT is recommended for symptomatic patients with HF in sinus rhythm with a QRS duration 130–149 ms and LBBB QRS morphology, and with LVEF ≤35%, despite optimal medical therapy to improve symptoms, and reduce morbidity and mortality. ^{355,356,383–392}	I	B
Comprehensive risk profiling and multidisciplinary management, including treatment of major comorbidities such as hypertension, hyperlipidaemia, diabetes, anaemia, and obesity, as well as smoking cessation and lifestyle modification, are recommended. ^{393–396}	I	A
Myocardial revascularization is recommended when angina persists despite treatment with antianginal drugs. ^{348,357,397}	I	A

ACE inhibitor = angiotensin-converting enzyme; ARB = angiotensin receptor blocker; b.p.m. = beats per minute; CCS = chronic coronary syndromes; CRT = cardiac resynchronization therapy; HF = heart failure; LBBB = left bundle branch block; LV = left ventricular; LVEF = left ventricular ejection fraction; MI = myocardial infarction; MRA = mineralocorticoid receptor antagonist.

^aClass of recommendation.

^bLevel of evidence.

5 Patients with a long-standing diagnosis of chronic coronary syndromes

In patients with a long-standing diagnosis of CCS, lifelong treatment and surveillance are required (Figure 10). The clinical course of patients with CCS may be benign over the course of time. However, patients with CCS may develop a variety of cardiovascular complications or undergo therapeutic measures, some directly related to the underlying CAD, and some having therapeutic or prognostic interactions with the underlying disease. Risk for complications may occur in an otherwise asymptomatic patient, and thus the assessment of risk status applies to symptomatic and asymptomatic patients.

Periodic assessment of the patient's individual risk may be considered (Figure 10). Scores that apply clinical parameters have been shown to predict outcomes among patients with CCS. Moreover, if the clinical parameters are complemented by biomarkers, such a risk score may be even more accurate. In 2017, a biomarker-based risk model to predict cardiovascular mortality in patients with CCS was developed and externally validated.³⁹⁸

5.1 Patients with stabilized symptoms < 1 year after an acute coronary syndrome or patients with recent revascularization

After revascularization and/or after stabilized ACS (<1 year), patients should be monitored more vigilantly, because they are at greater risk for complications and because they are subject to changes in pharmacological treatment.⁴⁵ Thus, we recommend at least two visits in the first year of follow-up. In a patient who had LV systolic dysfunction before the revascularization procedure or after the ACS, a reassessment of LV function must be considered 8–12 weeks after the intervention. Cardiac function may have improved, owing to mechanisms

such as recovery from myocardial stunning or hibernation, which may be reversed by revascularization.^{52,53} Conversely, cardiac function may have deteriorated given other concomitant CVD (e.g. valvular disease, infection or inflammation, arrhythmia, etc.). In such cases, these other damaging factors need to be identified and treated. Likewise, non-invasive assessment of myocardial ischaemia may be considered after revascularization to rule-out residual ischaemia or to document the residual ischaemia as reference for subsequent assessments over time.

5.2 Patients > 1 year after initial diagnosis or revascularization

To assess a patient's risk, an annual evaluation by a cardiovascular practitioner (cardiologist, general physician, or nurse) is warranted, even if the patient is asymptomatic. It is recommended that the annual evaluation should assess the patient's overall clinical status and medication compliance, as well as the risk profile (as reflected by risk scores). Laboratory tests—which include a lipid profile, renal function, a complete blood count, and possibly biomarkers—should be performed every 2 years.⁴⁵ A patient with a worsening risk score over time may warrant more intense therapy or diagnostic measures, although risk score-guided therapy has not yet been proved to ameliorate outcomes.

A 12 lead ECG should be a part of every such visit to delineate heart rate and heart rhythm, to detect changes suggestive of silent ischaemia/infarction, and to discern abnormalities in the specific electrocardiographic segments (e.g. PR, QRS, and QT intervals). It may be beneficial to assess LV function (diastolic and systolic), valvular status, and cardiac dimensions in apparently asymptomatic patients every 3–5 years.^{52,53} In cases of unexplained reduction in systolic LV function, especially if regional, imaging of coronary artery anatomy is recommended. Likewise, it may be beneficial to assess non-invasively for silent ischaemia in an apparently asymptomatic patient every 3–5

years, preferably applying stress imaging. Coronary CTA should not be used for follow-up of patients with established CAD given its strength on morphological insight, but lack of functional information related to ischaemia. However, coronary CTA may be used for unique cases, such as delineation of patency of coronary artery bypass grafts.

The lipid profile and glycaemia status should be reassessed periodically to determine efficacy of treatment and, in patients without diabetes, to detect new development of diabetes. There is no evidence

to support recommendations for the frequency of reassessment of these risk factors, but consensus suggests annual evaluation.

Elevated inflammatory markers, particularly of high-sensitivity C-reactive protein, have also been associated with an increased event risk in patients with and without CAD in multiple studies,²⁵ although the robustness of the association has been questioned because of reporting and publication bias.³⁹⁹ In addition, von Willebrand factor, interleukin-6, and N-terminal pro-B-type natriuretic peptide (NT-proBNP) have identified as been predictors of outcome.²⁵ Other

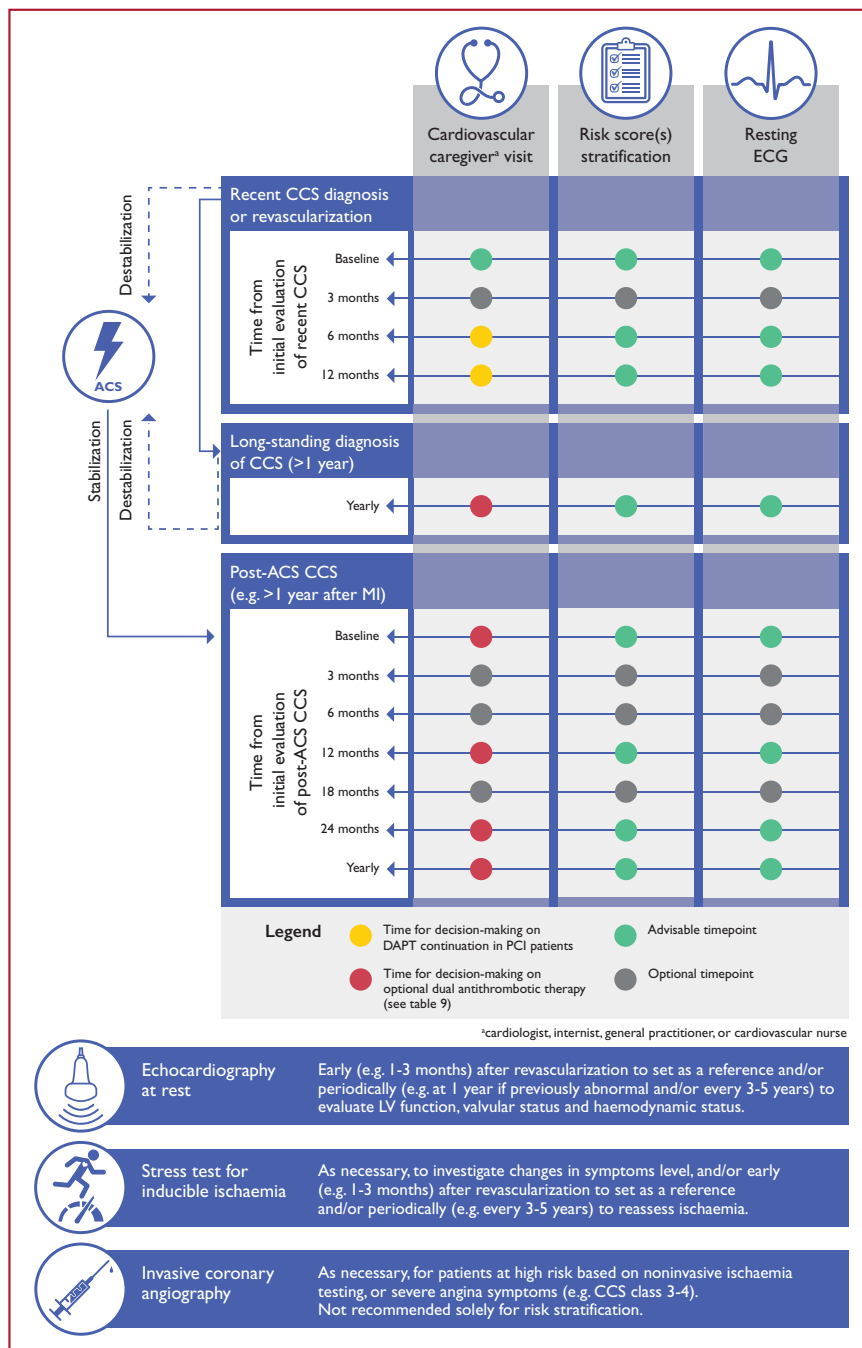

Figure 10 Proposed algorithm according to patient types commonly observed at chronic coronary syndrome outpatient clinics. The frequency of follow-up may be subject to variation based on clinical judgement. ACS = acute coronary syndromes; CCS = chronic coronary syndromes; DAPT = dual antiplatelet therapy; ECG = electrocardiogram; LV = left ventricular; MI = myocardial infarction; PCI = percutaneous coronary intervention. ^aCardiologist, internist, general practitioner, or cardiovascular nurse.

readily available biomarkers shown to predict prognosis in patients with CCS include heart rate, haemoglobin, and white cell count.⁴⁰⁰ Scores based on aggregated biomarkers may have greater success than individual biomarkers. A multiple biomarker score combining high-sensitivity C-reactive protein, heat shock protein 70, and fibrin degradation products significantly improved C-statistics and the net reclassification index compared with a basic model using clinical data.⁴⁰¹ Similar results were reported for a combination of high-sensitivity cardiac troponin T, NT-proBNP, and LDL-C.³⁹⁸ In several studies, genetic risk scores have been shown to improve risk prediction above traditional risk factors in general population samples^{402,403} and to predict recurrent events in populations with known CCS.^{404–407} Although there is additional prognostic value in using several individual and aggregated biomarkers, there is currently no evidence that routine use leads to improved care. Nevertheless, these measurements may have a role in selected patients (e.g. when testing for haemostatic abnormalities in those with previous MI without conventional risk factors or a strong family history of CAD).

Patients with unequivocal symptoms suggestive of ACS should be expeditiously referred for evaluation, applying current Guidelines for diagnosis and management. Among patients with more equivocal symptoms, stress imaging is recommended⁴⁰⁸ and, if not available and the ECG is amenable to identification of ischaemia, exercise stress electrocardiography can be used as an alternative. In patients with severe angina and a high-risk clinical profile, direct referral for ICA is recommended, provided that *ad hoc* physiological assessment of haemodynamic stenosis significance is readily available in the catheterization laboratory [e.g. instantaneous wave-free ratio (iwFR) or FFR]. Likewise, ICA is recommended for patients with evidence of significant ischaemia obtained by non-invasive testing.

6 Angina without obstructive disease in the epicardial coronary arteries

In clinical practice, a marked discrepancy between findings regarding coronary anatomy, the presence of symptoms, and the results of non-invasive tests frequently occurs.¹³ These patients deserve attention, as angina and non-obstructive disease are associated with an increased risk of adverse clinical events.¹⁴ Low diagnostic yield of ICA can be explained by the presence of: (i) stenoses with mild or moderate angiographic severity, or diffuse coronary narrowing, with underestimated functional significance identified by ICA; (ii) disorders affecting the microcirculatory domain that escape the resolution of angiographic techniques; and (iii) dynamic stenoses of epicardial vessels caused by coronary spasm or intramyocardial bridges that are not evident during CTA or ICA. Intracoronary pressure measurements are useful in circumventing the first of these scenarios. For diagnostic workup, patients with angina and/or myocardial ischaemia showing coronary stenoses with non-ischaemic FFR or iwFR values may also be labelled as having non-obstructive epicardial disease.

The presence of clear-cut anginal symptoms and abnormal non-invasive tests in patients with non-obstructed epicardial vessels should lead to the suspicion of a non-obstructive cause of ischaemia. Quite often, and mainly as a result of persistence of symptoms, patients with angina and no obstructive disease undergo multiple diagnostic tests, including repeated coronary CTA or ICA, that contribute to increased healthcare costs.⁴⁰⁹ Because diagnostic pathways to investigate microcirculatory or vasomotor coronary disorders are often not implemented, a final diagnosis supported by objective

Recommendations for patients with a long-standing diagnosis of chronic coronary syndromes

Recommendations for asymptomatic patients	Class ^a	Level ^b
A periodic visit to a cardiovascular healthcare professional is recommended to reassess any potential change in the risk status of patients, entailing clinical evaluation of lifestyle-modification measures, adherence to targets of cardiovascular risk factors, and the development of comorbidities that may affect treatments and outcomes.	I	C
In patients with mild or no symptoms receiving medical treatment in whom non-invasive risk stratification indicates a high risk, and for whom revascularization is considered for improvement of prognosis, invasive coronary angiography (with FFR when necessary) is recommended.	I	C
Coronary CTA is not recommended as a routine follow-up test for patients with established CAD.	III	C
Invasive coronary angiography is not recommended solely for risk stratification.	III	C
Symptomatic patients		
Reassessment of CAD status is recommended in patients with deteriorating LV systolic function that cannot be attributed to a reversible cause (e.g. long-standing tachycardia or myocarditis).	I	C
Risk stratification is recommended in patients with new or worsening symptom levels, preferably using stress imaging or, alternatively, exercise stress ECG. ⁴⁰⁸	I	B
It is recommended to expeditiously refer patients with significant worsening of symptoms for evaluation.	I	C
Invasive coronary angiography (with FFR/iwFR when necessary) is recommended for risk stratification in patients with severe CAD, particularly if the symptoms are refractory to medical treatment or if they have a high-risk clinical profile.	I	C

CAD = coronary artery disease; CTA = computed tomography angiography; ECG = electrocardiogram; FFR = fractional flow reserve; iwFR = instantaneous wave-free ratio; LV = left ventricular.

^aClass of recommendation.

^bLevel of evidence.

evidence is seldom reached. Owing to this, patient dismay and depression are not rare in this clinical population.^{410,411} Of note, the use of a structured, systematic approach to explore microcirculatory and vasomotor disorders in patients with non-obstructive CAD, as delineated below, has been shown to increase diagnostic yield.^{412,413} Furthermore, an RCT, which reported in 2018, found that in patients with non-obstructive coronary disease, tailored treatment guided by the results of intracoronary testing [coronary flow reserve (CFR), microcirculatory resistance, and acetylcholine testing] resulted in a significant reduction of anginal symptoms, compared with conventional, non-guided medical treatment.⁴¹⁴

6.1 Microvascular angina

Patients with microvascular angina typically have exercise-related angina, evidence of ischaemia in non-invasive tests, and either no stenoses or mild-to-moderate stenoses (40–60%), revealed by ICA or CTA, that are deemed functionally non-relevant.⁴¹⁵ Given the similarity of angina symptoms, a microvascular origin of angina is typically suspected, after excluding obstructive epicardial coronary stenoses, during diagnostic workup of patients with suspected myocardial ischaemia. Regional LV wall motion abnormalities rarely develop during exercise or stress in patients with microvascular angina.^{412,416} Some patients may also have a mixed pattern of angina, with occasional episodes at rest, particularly associated with exposure to cold.

Secondary microvascular angina, in the absence of epicardial obstruction, may result from cardiac or systemic conditions, including those that cause LV hypertrophy (such as hypertrophic cardiomyopathy, aortic stenosis, and hypertensive heart disease) or inflammation (such as myocarditis or vasculitis).⁴¹⁷

6.1.1 Risk stratification

The presence of microcirculatory dysfunction in patients with CCS entails a worse prognosis than originally thought, probably because most recent evidence has been based on follow-up of patients in whom abnormalities in the microcirculation have been objectively documented with invasive or non-invasive techniques.^{418–423}

Microcirculatory dysfunction precedes the development of epicardial lesions, particularly in women,⁴¹⁹ and is associated with impaired outcomes. Among patients with diabetes undergoing diagnostic workup, those without obstructive epicardial disease but with an abnormal CFR have similarly poor long-term prognosis as those with obstructive epicardial disease.⁴²¹ In patients with non-significant coronary stenoses by FFR, the presence of abnormal CFR is associated with an excess of events in the long-term,^{418,422,423} particularly when the index of microcirculatory resistance (IMR) is also abnormal.⁴²²

6.1.2 Diagnosis

The possibility of a microcirculatory origin of angina should be considered in patients with clear-cut angina, abnormal non-invasive functional tests, and coronary vessels that are either normal or have mild stenosis deemed functionally non-significant on ICA or CTA. One of

the challenges in performing a comprehensive assessment of microvascular function is testing the two main mechanisms of dysfunction separately: impaired microcirculatory conductance and arteriolar dysregulation.^{424–426} Yet, outlining which of these two pathways is affected is critically relevant in setting medical treatment to relieve patient symptoms.⁴¹⁴

Impaired microcirculatory conductance can be diagnosed by measuring CFR or minimal microcirculatory resistance (the inverse of conductance). CFR can be measured non-invasively with transthoracic Doppler echocardiography [by imaging left anterior descending (LAD) flow],⁴²⁷ magnetic resonance imaging (myocardial perfusion index),^{428–430} or PET.⁴³¹ Microcirculatory resistance can be measured in the catheterization laboratory by combining intracoronary pressure with thermodilution-based data (to calculate the IMR) or Doppler flow velocity (to calculate hyperaemic microvascular resistance or HMR).^{432,433} Both intracoronary thermodilution and Doppler allow the calculation of CFR. For decision-making purposes, values of IMR ≥ 25 units or CFR < 2.0 are indicative of abnormal microcirculatory function.⁴¹⁴ Both CFR and IMR are typically measured while using intravenous vasodilators, such as adenosine or regadenoson.

In contrast, the diagnosis of *arteriolar dysregulation* requires the assessment of endothelial function in the coronary microcirculation by selective intracoronary acetylcholine infusion (see section 6.5). In the presence of dysfunctional vascular endothelium or abnormal function of smooth muscle cells, acetylcholine (an endothelium-dependent vasodilator that also acts directly on smooth muscle cells) triggers paradoxical arteriolar vasoconstriction.⁴³⁴ Thus, in patients with microvascular angina and arteriolar dysregulation, acetylcholine challenge is likely to trigger microvascular spasm. This arteriolar response to acetylcholine causes anginal symptoms with or without concomitant ischaemic ECG changes, and a decrease in coronary blood flow velocity if concomitant Doppler measurements are performed. Peripheral pulse tonometry during reactive hyperaemia may also reveal abnormal systemic endothelial function in patients with angina and non-obstructive CAD.⁴³⁵

6.1.3 Treatment

Treatment of microvascular angina should address the dominant mechanism of microcirculatory dysfunction. In patients with abnormal CFR < 2.0 or IMR ≥ 25 units, and a negative acetylcholine provocation test, beta-blockers, ACE inhibitors, and statins, along with lifestyle changes and weight loss, are indicated.^{436,437} Patients developing ECG changes and angina in response to acetylcholine testing but without severe epicardial vasoconstriction (all suggestive of microvascular spasm) may be treated like vasospastic angina patients. The effectiveness of a tailored treatment strategy was investigated in the CorMiCa trial, which randomized 151 patients to a stratified medical treatment (based on the results of CFR, IMR, and acetylcholine testing) vs. a standard-care group (including a sham interventional diagnostic procedure). At 1 year, there was a significant difference in angina scores favouring patients assigned to the stratified medical treatment arm.⁴¹⁴

Investigations in patients with suspected coronary microvascular angina

Recommendations	Class ^a	Level ^b
Guidewire-based CFR and/or microcirculatory resistance measurements should be considered in patients with persistent symptoms, but coronary arteries that are either angiographically normal or have moderate stenoses with preserved iwFR/FFR. ^{412,413}	IIa	B
Intracoronary acetylcholine with ECG monitoring may be considered during angiography, if coronary arteries are either angiographically normal or have moderate stenoses with preserved iwFR/FFR, to assess microvascular vasospasm. ^{412,438–440}	IIb	B
Transthoracic Doppler of the LAD, CMR, and PET may be considered for non-invasive assessment of CFR. ^{430–432,441}	IIb	B

© ESC 2019

CFR = coronary flow reserve; CMR = cardiac magnetic resonance; ECG = electrocardiogram; FFR = fractional flow reserve; iwFR = instantaneous wave-free ratio; LAD = left anterior descending; PET = positron emission tomography.

^aClass of recommendation.

^bLevel of evidence.

6.2 Vasospastic angina

Vasospastic angina should be suspected in patients with anginal symptoms occurring predominantly at rest, with maintained effort tolerance. The likelihood of vasospastic angina increases when attacks follow a circadian pattern, with more episodes at night and in the early morning hours. Patients are frequently younger and have fewer cardiovascular risk factors than patients with effort angina, except for cigarette smoking.⁴⁴² Coronary vasospasm should be also suspected in patients with patent coronary stents and persistent angina.^{443,444}

6.2.1 Diagnosis

The diagnosis of vasospastic angina is based on detecting transient ischaemic ST-segment changes during an angina attack (usually at rest). Patients with Prinzmetal angina represent a special subset in whom resting angina is accompanied by transient ST-segment elevation.^{442,445} These ECG changes correlate with proximal vessel occlusion and diffuse, distal subocclusive narrowing of epicardial vessels. As most attacks of vasospastic angina are self-limiting, documentation of these ECG changes is challenging. Ambulatory ECG monitoring, preferably with 12 lead recording, may be helpful in patients in whom vasospastic angina is suspected. The occurrence of ST-segment shifts at normal heart rate supports the likelihood of myocardial ischaemia caused by spasm. Extended Holter monitoring (for >1 week) may be required for successful documentation of transient ST-segment changes in these patients. Ambulatory ECG monitoring may also be used to assess the results of medical therapy in controlling the frequency of vasospastic events.

In patients with suspected vasospastic angina and documented ECG changes, CTA or ICA is indicated to rule-out the presence of fixed

coronary stenosis. Angiographic documentation of coronary spasm requires the use of a provocation test in the catheterization laboratory. Given the low sensitivity of hyperventilation and the cold pressor test, intracoronary administration of acetylcholine or ergonovine during ICA are the preferred provocation tests.⁴⁴² Both pharmacological agents are safe, provided that they are selectively infused into the left or right coronary artery, and that triggered spasm is readily controlled with intracoronary nitrates. A low percentage of patients may develop ventricular tachycardia/ventricular fibrillation or bradyarrhythmias during the provocation test (3.2 and 2.7%, respectively), similar to that reported during spontaneous spasm attacks (7%).⁴⁴⁶ Intravenous administration of ergonovine for non-invasive tests should be discouraged due to the risk of triggering prolonged spasm in multiple vessels, which may be very difficult to manage and can be fatal.⁴⁴⁷

A provocation test for coronary spasm is considered positive when it triggers: (i) anginal symptoms, (ii) ischaemic ECG changes, and (iii) severe vasoconstriction of the epicardial vessel. Should the test fail in triggering all three components, it should be considered equivocal.⁴⁴² The development of angina in response to acetylcholine injections in the absence of angiographically evident spasm, with or without accompanying ST-segment changes, may indicate microvascular spasm and is seen frequently in patients presenting with microvascular angina.⁴⁴⁵

6.2.2 Treatment

In patients with epicardial or microcirculatory vasomotor disorders, CCBs and long-acting nitrates constitute the treatment of choice, in addition to the control of cardiovascular risk factors and lifestyle changes.^{437,445} Nifedipine has been shown to be effective in reducing coronary spasm associated with stent implantation.⁴⁴⁴

Recommendations for investigations in patients with suspected vasospastic angina

Recommendations	Class ^a	Level ^b
An ECG is recommended during angina if possible.	I	C
Invasive angiography or coronary CTA is recommended in patients with characteristic episodic resting angina and ST-segment changes, which resolve with nitrates and/or calcium antagonists, to determine the extent of underlying coronary disease.	I	C
Ambulatory ST-segment monitoring should be considered to identify ST-segment deviation in the absence of increased heart rate.	IIa	C
An intracoronary provocation test should be considered to identify coronary spasm in patients with normal findings or non-obstructive lesions on coronary arteriography and a clinical picture of coronary spasm, to diagnose the site and mode of spasm. ^{412,414,438–440}	IIa	B

© ESC 2019

CTA = computed tomography angiography; ECG = electrocardiogram.

^aClass of recommendation.

^bLevel of evidence.

7 Screening for coronary artery disease in asymptomatic subjects

In an effort to lower the high burden of coronary deaths in asymptomatic adults, numerous measurements of risk factors and risk markers, as well as stress tests, are often performed as screening investigations. The 2016 European Guidelines on CVD prevention in clinical practice have focused on these issues in detail.¹⁵ These recommendations have been adapted for the purpose of these Guidelines.

In general, the use of risk-estimation systems such as SCORE is recommended (see also *Figure 6*). Subjects with a family history of premature CAD should be screened for familial hypercholesterolaemia. Coronary calcium score, ankle-brachial index, and carotid ultrasound for plaque detection may provide useful information about the atherosclerotic risk in selected patients, but routine use of biomarkers or other imaging tests for CAD are not recommended. The new biomarkers have incremental predictive value over classical ones,⁴⁴⁸ but the net reclassification improvement is still only modest (7–18%) compared, for example, with the coronary calcium score, which has a net reclassification improvement of 66%.⁴⁴⁹

Only subjects at high event risk should be considered for further non-invasive or invasive testing. There are no data on how to manage

asymptomatic subjects who receive testing and have a positive test result beyond the recommendations listed in these Guidelines. However, the principles of risk stratification, as described above for symptomatic patients, also apply to these individuals.⁴⁵⁰ It is important to remember that data demonstrating improved prognosis following appropriate management based on new biomarkers are still lacking.

It is important to note that patients with cancer and undergoing cancer treatment, or chronic inflammatory diseases such as inflammatory bowel diseases, rheumatoid arthritis, and systemic lupus erythematosus, may deserve more intensive risk screening, counseling, and management.^{451–454}

Persons whose occupations involve public safety (e.g. airline pilots, or lorry or bus drivers), or who are professional or high-profile athletes, commonly undergo periodic testing for the assessment of exercise capacity and evaluation of possible heart disease, including CAD. Although there are insufficient data to justify this approach, these evaluations may be done for medicolegal reasons. The threshold for performing an imaging test in such persons may be lower than in the average patient. Otherwise, the same considerations as discussed above for other asymptomatic persons apply to these individuals.

Recommendations for screening for coronary artery disease in asymptomatic subjects

Recommendations	Class ^a	Level ^b
Total risk estimation using a risk-estimation system such as SCORE is recommended for asymptomatic adults >40 years of age without evidence of CVD, diabetes, CKD, or familial hypercholesterolaemia.	I	C
Assessment of family history of premature CVD (defined as a fatal or non-fatal CVD event, or/and established diagnosis of CVD in first-degree male relatives before 55 years of age or female relatives before 65 years of age) is recommended as part of cardiovascular risk assessment.	I	C
It is recommended that all individuals aged <50 years with a family history of premature CVD in a first-degree relative (<55 years of age in men or <65 years of age in women) or familial hypercholesterolaemia are screened using a validated clinical score. ^{455,456}	I	B
Assessment of coronary artery calcium score with computed tomography may be considered as a risk modifier ^c in the cardiovascular risk assessment of asymptomatic subjects. ^{449,457}	IIb	B
Atherosclerotic plaque detection by carotid artery ultrasound may be considered as a risk modifier ^c in the cardiovascular risk assessment of asymptomatic subjects. ⁴⁵⁸	IIb	B
ABI may be considered as a risk modifier ^c in cardiovascular risk assessment. ⁴⁵⁹	IIb	B
In high-risk asymptomatic adults (with diabetes, a strong family history of CAD, or when previous risk-assessment tests suggest a high risk of CAD), functional imaging or coronary CTA may be considered for cardiovascular risk assessment.	IIb	C
In asymptomatic adults (including sedentary adults considering starting a vigorous exercise programme), an exercise ECG may be considered for cardiovascular risk assessment, particularly when attention is paid to non-ECG markers such as exercise capacity.	IIb	C
Carotid ultrasound IMT for cardiovascular risk assessment is not recommended. ⁴⁶⁰	III	A
In low-risk non-diabetic asymptomatic adults, coronary CTA or functional imaging for ischaemia are not indicated for further diagnostic assessment.	III	C
Routine assessment of circulating biomarkers is not recommended for cardiovascular risk stratification. ^{448,449,461,462}	III	B

ABI = ankle-brachial index; CAD = coronary artery disease; CKD = chronic kidney disease; CTA = computed tomography angiography; CVD = cardiovascular disease; ECG = electrocardiogram; IMT = intima-media thickness; SCORE = Systematic COronary Risk Evaluation.

^aClass of recommendation.

^bLevel of evidence.

^cReclassifies patients better into low- or high-risk groups.

8 Chronic coronary syndromes in specific circumstances

8.1 Cardiovascular comorbidities

8.1.1 Hypertension

Hypertension is the most prevalent cardiovascular risk factor and is closely associated with CCS. Thresholds for the definition of hypertension are provided in *Table 10*. BP lowering can significantly reduce major cardiovascular risk, including CHD. Meta-analysis suggests that for every 10 mmHg reduction in systolic BP, CAD can be reduced by 17%.⁴⁶³ More intensive BP targets (office BP <130 mmHg) have been associated with favourable outcomes and are endorsed by the 2018 ESC/ESH Guidelines for the management of arterial hypertension.⁴⁶⁴ It is recommended treat hypertensive patients with CCS are treated to office targets of 130/80 mmHg, because an increased systolic BP of ≥ 140 mmHg and diastolic BP of ≥ 80 mmHg, but also a systolic BP of <120 mmHg and diastolic BP of <70 mmHg, are associated with increased risk^{465,466} (*Table 10*). Whether the J-curve phenomenon exists in patients with revascularized CAD remains uncertain. In hypertensive patients with CHD, beta-blockers and RAS blockers may improve post-MI outcomes.⁴⁶⁷ In patients with symptomatic angina, beta-blockers and calcium antagonists are the preferred components of the drug-treatment strategy. The combination of ACE inhibitors and ARBs is not recommended for the treatment of hypertension because of increased renal adverse events without beneficially influencing outcome.^{468,469}

Table 10 Blood pressure thresholds for the definition of hypertension with different types of blood pressure measurement^{470–472}

Category	Systolic BP (mmHg)	and/or	Diastolic BP (mmHg)
Office BP	≥ 140	and/or	≥ 90
≥ 80 years of age	≥ 160	and/or	≥ 90
Ambulatory BP			
Daytime (or awake)	≥ 135	and/or	≥ 85
Night-time (or asleep)	≥ 120	and/or	≥ 70
24 h	≥ 130	and/or	≥ 80
Home BP	≥ 135	and/or	≥ 85

BP = blood pressure.

Recommendations for hypertension treatment in chronic coronary syndromes

Recommendations	Class ^a	Level ^b
It is recommended that office BP is controlled to target values: systolic BP 120 - 130 mmHg in general and systolic BP 130 - 140 mmHg in older patients (aged >65 years). ^{463–467,470–472}	I	A
In hypertensive patients with a recent MI, beta-blockers and RAS blockers are recommended. ⁴⁶⁷	I	A
In patients with symptomatic angina, beta-blockers and/or CCBs are recommended. ⁴⁶⁷	I	A
The combination of ACE inhibitors and ARBs is not recommended. ^{468,469}	III	A

ACE = angiotensin converting enzyme; ARB = angiotensin receptor blocker; BP = blood pressure; CCB = calcium channel blocker; RAS = renin-angiotensin system.

^aClass of recommendation.

^bLevel of evidence.

8.1.2 Valvular heart disease (including planned transcatheter aortic valve implantation)

Coronary angiography for the assessment of CAD is recommended before valve surgery or when percutaneous valvular intervention is planned, to determine if revascularization is required. Coronary CTA may be considered in patients with low risk for CAD, or in patients in whom conventional ICA is technically not feasible or associated with increased risk. The combination of PCI and transcatheter aortic valve implantation appears feasible and safe, but more data are needed before definite recommendations can be provided.^{473,474} The routine use of stress testing to detect CAD associated with severe symptomatic valvular disease is not recommended because of low diagnostic value and potential risk. Symptom-limited stress testing in patients with valvular heart disease appears safe, and may be useful to unmask symptoms in asymptomatic patients or in patients with equivocal symptoms.⁴⁷⁵

Recommendations for valvular disease in chronic coronary syndromes⁴⁷⁶

Recommendations	Class ^a	Level ^b
ICA is recommended before valve surgery and for any of the following: history of CVD, suspected myocardial ischaemia, LV systolic dysfunction, in men >40 years of age and postmenopausal women, or one or more cardiovascular risk factors.	I	C
ICA is recommended in the evaluation of moderate-to-severe functional mitral regurgitation.	I	C
Coronary CTA should be considered as an alternative to coronary angiography before valve intervention in patients with severe valvular heart disease and low probability of CAD.	IIa	C
PCI should be considered in patients undergoing transcatheter aortic valve implantation and coronary artery diameter stenosis >70% in proximal segments.	IIa	C
In severe valvular heart disease, stress testing should not be routinely used to detect CAD because of the low diagnostic yield and potential risks.	III	C

CAD = coronary artery disease; CTA = computed tomography angiography; CVD = cardiovascular disease; ICA = invasive coronary angiography; LV = left ventricular; PCI = percutaneous coronary intervention.

^aClass of recommendation.

^bLevel of evidence.

8.1.3 After heart transplantation

The follow-up and assessment of long-term heart transplant survivors requires specific know-how. Transplant CAD is largely an immunological phenomenon, and remains a significant cause of morbidity and mortality.⁴⁷⁷ ICA is recommended for the assessment of transplant CAD and should be performed annually for 5 years after transplantation. If there are no significant abnormalities, angiograms can be performed biannually thereafter. Intravascular ultrasound

examinations may be useful in assessing cardiac allograft vasculopathy and plaque stability.⁴⁷⁸ Treatment options for CAD in transplant recipients include pharmacotherapy and revascularization. PCI in the transplanted heart has become an established therapy.⁴⁷⁹

8.2 Non-cardiovascular comorbidities

8.2.1 Cancer

Occurrence of CAD in patients with active cancer is increasing^{451,452} as a side effect of cancer therapy (i.e. radiotherapy to the thorax/mediastinum, cardiotoxic chemotherapy, or immunotherapies) or a result of extended cancer therapies in elderly individuals. CAD in patients with active cancer is associated with challenges for clinicians as treatment decisions should be the subject of individualized discussions based on life expectancy, additional comorbidities such as thrombocytopenia, increased thrombosis and bleeding propensity, and potential interactions between drugs used in CCS management and antineoplastic drugs. In cancer patients with increased frailty, the least invasive revascularization procedures are recommended. For further information, see the ESC position paper on cancer treatments and cardiovascular toxicity.⁴⁸⁰

Recommendations for active cancer in chronic coronary syndromes

Recommendations	Class ^a	Level ^b
Treatment decisions should be based on life expectancy, additional comorbidities such as thrombocytopenia, increased thrombosis propensity, and potential interactions between drugs used in CCS management and antineoplastic agents.	I	C
If revascularization is indicated in highly symptomatic patients with active cancer and increased frailty, the least invasive procedure is recommended.	I	C

CCS = chronic coronary syndromes.
^aClass of recommendation.
^bLevel of evidence.

8.2.2 Diabetes mellitus

Diabetes mellitus confers about a two-fold increased risk for CAD⁴⁸¹ and, consequently, control of risk factors is recommended for the prevention of CVD. Systolic BP in patients with diabetes should be targeted to ≤130 mmHg, if tolerated, but not <120 mmHg, and diastolic BP to <80 mmHg, but not <70 mmHg.⁴⁸² Initial antihypertension treatment should consist of a combination of a RAS blocker with a CCB or thiazide/thiazide-like diuretic. ACE inhibitors reduce albuminuria, and the appearance or progression of diabetic nephropathy, more effectively than other drug classes.⁴⁸² Patients with diabetes and CAD are considered to be at very high risk; consequently, LDL-C should be lowered to <1.8 mmol/L (<70 mg/dL) or reduced by

≥50% if the baseline LDL-C is between 1.8 and 3.5 mmol/L (70 and 135 mg/dL).¹⁵ For the majority of patients with diabetes and CAD, a target glycated HbA1c level of <7% (<53 mmol/L) is recommended.^{483,484} Large safety studies on new glucose-lowering drugs, namely sodium-glucose co-transporter-2 and glucagon-like peptide-1 receptor agonists, have demonstrated significant reductions in cardiovascular events. Indications for their clinical use are described in the 2019 ESC/European Association for the Study of Diabetes Guidelines on diabetes mellitus, pre-diabetes, and cardiovascular diseases.¹⁶

A 12 lead ECG is recommended as part of the routine assessment for screening for conduction abnormalities, LV hypertrophy, and arrhythmias. The high prevalence of significant CAD and prohibitively high cardiovascular mortality may suggest the usefulness of routine screening for CAD (with functional imaging testing or coronary CTA) in asymptomatic patients with diabetes, but no data have shown an improvement in outcomes so far. Routine use of CTA in asymptomatic patients with diabetes is therefore not recommended.

Recommendations for diabetes mellitus in chronic coronary syndromes

Recommendations	Class ^a	Level ^b
Risk factor (BP, LDL-C, and HbA1c) control to targets is recommended in patients with CAD and diabetes mellitus. ^{482–484}	I	A
In asymptomatic patients with diabetes mellitus, a periodic resting ECG is recommended for cardiovascular detection of conduction abnormalities, AF, and silent MI.	I	C
ACE inhibitor treatment is recommended in CCS patients with diabetes for event prevention. ⁴⁸²	I	B
The sodium-glucose co-transporter 2 inhibitors empagliflozin, canagliflozin, or dapagliflozin are recommended in patients with diabetes and CVD. ^{c 485–487}	I	A
A glucagon-like peptide-1 receptor agonist (liraglutide or semaglutide) is recommended in patients with diabetes and CVD. ^{c 488–490}	I	A
In asymptomatic adults (age >40 years) with diabetes, functional imaging or coronary CTA may be considered for advanced cardiovascular risk assessment. ^{491,492}	IIb	B

ACE = angiotensin-converting enzyme; AF = atrial fibrillation; BP = blood pressure; CAD = coronary artery disease; CCS = chronic coronary syndromes; CTA = computed tomography angiography; CVD = cardiovascular disease; ECG = electrocardiogram; HbA1c = glycated haemoglobin; LDL-C = low-density lipoprotein cholesterol; MI = myocardial infarction.

^aClass of recommendation.

^bLevel of evidence.

^cTreatment algorithm is available in the 2019 European Society of Cardiology/European Association for the Study of Diabetes Guidelines on diabetes mellitus, pre-diabetes, and cardiovascular diseases.¹⁶

8.2.3 Chronic kidney disease

CAD is highly prevalent in patients with CKD and a growing number of patients undergoing PCI have concomitant CKD.⁴⁹³ There is a linear increase in the risk of cardiovascular mortality with decreasing GFR.⁴⁹⁴ Medical treatment for risk-factor control (lipids, BP, and glucose) can improve outcomes. Special attention during the workup for CKD patients with suspected obstructive CAD should be paid to the fact that angina is less common and silent ischaemia more common.⁴⁹⁵ Additionally, non-invasive stress testing shows reduced accuracy in patients with CKD.⁴⁹⁶ The use of an iodinated contrast agent should be minimized to prevent further deterioration of renal function. Decisions regarding diagnostic and treatment modalities should be made accordingly. Interestingly, patients with CKD are less likely to receive invasive management for treatment of CAD compared with those without, although benefits of invasive management have been reported.⁴⁹⁷ Revascularization options in patients with CKD include CABG and PCI. Meta-analyses suggest that CABG is associated with higher short-term risk of death, stroke, and repeat revascularization, whereas PCI with a new-generation DES is associated with a higher long-term risk of repeat revascularization.^{498,499} Data on patients on haemodialysis are very limited, making generalizable treatment recommendations difficult.

Recommendations for chronic kidney disease in chronic coronary syndromes

Recommendations	Class ^a	Level ^b
It is recommended that risk factors are controlled to target values. ^{500–502}	I	A
It is recommended that special attention is paid to potential dose adjustments of renally excreted drugs used in CCS.	I	C
It is recommended that the use of iodinated contrast agents is minimized in patients with severe CKD and preserved urine production to prevent further deterioration. ^{503,504}	I	B

CKD = chronic kidney disease; CCS = chronic coronary syndromes.

^aClass of recommendation.

^bLevel of evidence.

8.2.4 Elderly

Ageing predisposes patients to a high incidence and prevalence of CAD, in both men and women. Elderly patients (age >75 years) have the greatest mortality and morbidity risk attributable to CCS, which is enriched by the high prevalence of comorbidities (e.g. hypertension, diabetes mellitus, CKD, etc.).⁵⁰⁵ Although the prevalence of elderly patients with CAD is increasing, this population is usually undertreated, underdiagnosed, and under-represented in clinical trials. Elderly patients often present with atypical symptoms, which may delay proper diagnosis. The treatment of CCS in the elderly is complicated by a higher vulnerability to complications for both conservative and invasive strategies, such as bleeding, renal failure, and neurological impairments, all of which require special attention. It is recommended that radial access is used whenever possible to reduce

access-site complications, when choosing an invasive strategy for patient management.^{506,507} The use of DES, compared with bare-metal stents, in combination with a short duration of DAPT is associated with significant safety and efficacy benefits in elderly patients.^{508,509}

Recommendations for elderly patients with chronic coronary syndromes

Recommendations	Class ^a	Level ^b
It is recommended that particular attention is paid to side effects of drugs, intolerance, and overdosing in elderly patients.	I	C
The use of DES is recommended in elderly patients. ^{508,509}	I	A
Radial access is recommended in elderly patients to reduce access-site bleeding complications. ^{506,507}	I	B
It is recommended that diagnostic and revascularization decisions are based on symptoms, the extent of ischaemia, frailty, life expectancy, and comorbidities.	I	C

DES = drug-eluting stents.

^aClass of recommendation.

^bLevel of evidence.

8.3 Sex

Making up ≤30% of study populations, women are widely under-represented in cardiovascular studies.⁵¹⁰ This recruitment bias causes an evidence gap, as sex-based randomized controlled studies are lacking, and most data are extracted from meta-analyses and *post hoc* analyses of trials in ACS patients. Differences in symptom presentation, the accuracy of diagnostic tests for CAD, and other factors that lead to differential triage, evaluation, or early treatment of women with myocardial ischaemia compared with men could contribute to their worse outcomes.^{511–514} Whether there are true sex-related differences in mortality after myocardial ischaemia, or whether they owing to older age or a higher prevalence of coexisting diseases in women, remains incompletely understood. It has become evident that sex-related mortality differences are particularly apparent in younger patients, typically those aged <60 years.^{511,512,515} The reasons for this age-dependent disparity in mortality remain unclear. Women tend to be treated less aggressively than men.⁵¹⁵ However, patient characteristics and treatments do not entirely account for sex differences in outcomes, even after PCI.⁵¹² It is therefore recommended that women who present with signs suggestive of cardiac ischaemia undergo careful investigation, as clinical symptoms might be atypical. The diagnostic accuracy of the exercise ECG is even lower in women than in men, which is in part related to functional impairment, precluding some women from achieving an adequate workload. Stress echocardiography with exercise or dobutamine stress is an accurate, non-invasive technique for the detection of obstructive CAD and risk among women with suspected CCS.⁵¹⁶ Both women and men have experienced improvements in mortality

when new-generation DES were used.^{517–519} The mortality reductions were similar among women and men leaving sex disparities in outcomes unchanged.⁵¹² Women have higher complication rates following CABG and may also have higher mortality risk,^{520,521} especially in elderly patients. Hormone replacement therapy in postmenopausal women does not reduce the risk of ischaemic myocardial disease (see section 3.3.5), and is therefore not recommended for primary and secondary prevention.^{344,522,523}

Recommendation for sex issues and chronic coronary syndromes

Recommendation	Class ^a	Level ^b
Hormone replacement therapy is not recommended for risk reduction in post-menopausal women.	III	C

^aClass of recommendation.

^bLevel of evidence.

© ESC 2019

8.4 Patients with refractory angina

Refractory angina refers to long-lasting symptoms (for ≥ 3 months) due to established reversible ischaemia in the presence of obstructive CAD, which cannot be controlled by escalating medical therapy with the use of second- and third-line pharmacological agents, bypass grafting, or stenting including PCI of chronic total coronary occlusion. Incidence is growing with more advanced CAD, multiple comorbidities, and ageing of the population. The quality of life of patients with refractory angina is poor, with frequent hospitalization and a high level of resource utilization. The number of potential treatment options is increasing, but the level of evidence in support of their safety and efficacy varies from non-existent (in the case of transmyocardial laser application) to promising. RCTs with endpoints such as the severity and frequency of angina, as well as quality of life, are

obviously needed, along with safety metrics. To confirm treatment efficacy, trials with a sham-controlled design are desirable, a significant placebo effect being part of the therapeutic effect. Patients with refractory angina are best treated in dedicated 'angina clinics' by multidisciplinary teams experienced in selecting the most suitable therapeutic approach in the individual patient based on an accurate diagnosis of the mechanisms of the pain syndrome. Once conventional anti-ischaemic targets have been exhausted (through an increase in nutrient blood flow delivery and/or reduction in oxygen consumption), novel therapies can be ranked by mechanism of action: promotion of collateral growth, transmural redistribution of blood flow, and neuromodulation of the cardiac pain syndrome (Table 11).

Both the STARTSTIM and RENEW (Efficacy and Safety of Targeted Intramyocardial Delivery of Auto CD34+ Stem Cells for Improving Exercise Capacity in Subjects With Refractory Angina) trials were underpowered due to premature study termination. Of note, a patient-level pooled analysis of 304 patients included in three double-blind, cell therapy, placebo-controlled trials, among which was the RENEW trial, showed that active treatment with autologous haematopoietic cells had significant effects on exercise time and angina frequency.⁵²⁸

Based on positive results from two RCTs in small groups of patients, both enhanced external counterpulsation and the coronary sinus reducer device represent alternative options in patients with refractory angina, which is resistant after having exhausted all options for medical therapy and mechanical revascularization. Controlled coronary sinus narrowing with the implantation of a large stainless-steel device increases coronary sinus pressure, leading to improved perfusion in the LAD territory.

Total reported experience with all novel therapeutic options remains limited, both regarding the number of treated patients and the duration of follow-up. Larger RCTs are required to define the role of each treatment modality for specific subgroups, to decrease non-responder rates and ascertain benefit beyond potential placebo effects.

Table 11 Potential treatment options for refractory angina and summary of trial data

Therapy	Type of therapy	RCT	Type of control group	Number of patients enrolled
External counterpulsation	Enhanced external counterpulsation	MUST ⁵²⁴	Sham	139
Extracorporeal shockwave	Low-energy extracorporeal shockwave therapy	Not available	Not available	—
Coronary sinus constriction	Reducer device	COSIRA ⁵²⁵	Sham	104
Neuromodulation	Spinal cord stimulation	STARTSTIM ⁵²⁶	Not available	68
	Transcutaneous electrical neural stimulation	Not available	Not available	—
	Subcutaneous electrical neural stimulation	Not available	Not available	—
	Sympathectomy	Denby <i>et al.</i> ⁵²⁷	Placebo	65
Gene therapy	Adenovirus fibroblast growth factor 5	Not available	Not available	—
Autologous cell therapy	Mononuclear bone marrow-derived haematopoietic progenitor cells	RENEW ⁵²⁸	Placebo	112

RCT = randomized clinical trial.

Recommendations for treatment options for refractory angina

Recommendations	Class ^a	Level ^b
Enhanced external counterpulsation may be considered for symptom relief in patients with debilitating angina refractory to optimal medical and revascularization strategies. ⁵²⁴	IIb	B
A reducer device for coronary sinus constriction may be considered to ameliorate symptoms of debilitating angina refractory to optimal medical and revascularization strategies. ⁵²⁵	IIb	B
Spinal cord stimulation may be considered to ameliorate symptoms and quality of life in patients with debilitating angina refractory to optimal medical and revascularization strategies. ⁵²⁶	IIb	B
Transmyocardial revascularization is not recommended in patients with debilitating angina refractory to optimal medical and revascularization strategies. ⁵²⁹	III	A

^aClass of recommendation.

^bLevel of evidence.

© ESC 2019

9 Key messages

- (1) Careful evaluation of patient history, including the characterization of anginal symptoms, and evaluation of risk factors and manifestations of CVD, as well as proper physical examination and basic testing, are crucial for the diagnosis and management of CCS.
- (2) Unless obstructive CAD can be excluded based on clinical evaluation alone, either non-invasive functional imaging or anatomical imaging using coronary CTA may be used as the initial test to rule-out or establish the diagnosis of CCS.
- (3) Selection of the initial non-invasive diagnostic test is based on the PTP, the test's performance in ruling-in or ruling-out obstructive CAD, patient characteristics, local expertise, and the availability of the test.
- (4) For revascularization decisions, both anatomy and functional evaluation are to be considered. Either non-invasive or invasive functional evaluation is required for the assessment of myocardial ischaemia associated with angiographic stenosis, unless very high grade (>90% diameter stenosis).
- (5) Assessment of risk serves to identify CCS patients at high event risk who are projected to derive prognostic benefit from revascularization. Risk stratification includes the assessment of LV function.
- (6) Patients at high event risk should undergo invasive investigation for consideration of revascularization, even if they have mild or no symptoms.
- (7) Implementation of healthy lifestyle behaviours decreases the risk of subsequent cardiovascular events and mortality, and is additional to appropriate secondary prevention therapy. Clinicians should advise on and encourage necessary lifestyle changes in every clinical encounter.
- (8) Cognitive behavioural interventions such as supporting patients to set realistic goals, self-monitor, plan how to implement changes and deal with difficult situations, set environmental cues, and engage social support are effective interventions for behaviour change.
- (9) Multidisciplinary teams can provide patients with support to make healthy lifestyle changes, and address challenging aspects of behaviour and risk.
- (10) Anti-ischæmic treatment must be adapted to the individual patient based on comorbidities, co-administered therapies, expected tolerance and adherence, and patient preferences. The choice of anti-ischæmic drugs to treat CCS should be adapted to the patient's heart rate, BP, and LV function.
- (11) Beta-blockers and/or CCBs remain the first-line drugs in patients with CCS. Beta-blockers are recommended in patients with LV dysfunction or HF with reduced ejection fraction.
- (12) Long-acting nitrates provoke tolerance with loss of efficacy. This requires prescription of a daily nitrate-free or nitrate-low interval of ~10–14 h.
- (13) Antithrombotic therapy is a key part of secondary prevention in patients with CCS and warrants careful consideration. Patients with a previous MI, who are at high risk of ischaemic events and low risk of fatal bleeding, should be considered for long-term DAPT with aspirin and either a P2Y₁₂ inhibitor or very low-dose rivaroxaban, unless they have an indication for an OAC such as AF.
- (14) Statins are recommended in all patients with CCS. ACE inhibitors (or ARBs) are recommended in the presence of HF, diabetes, or hypertension and should be considered in high-risk patients.
- (15) Proton pump inhibitors are recommended in patients receiving aspirin or combination antithrombotic therapy who are at high risk of gastrointestinal bleeding.
- (16) Efforts should be made to explain to patients the importance of evidence-based prescriptions to increase adherence to treatment, and repeated therapeutic education is essential in every clinical encounter.
- (17) Patients with a long-standing diagnosis of CCS should undergo periodic visits to assess potential changes in risk status, adherence to treatment targets, and the development of comorbidities. Repeat stress imaging or ICA with functional testing is recommended in the presence of worsening symptoms and/or increased risk status.
- (18) Assessment of myocardial and valvular function and dimensions, as well as a functional test to rule-out significant myocardial silent ischaemia, may be contemplated every 3–5 years in asymptomatic patients with a long-standing diagnosis of CCS.

- (19) An assessment of coronary vasomotor function should be considered in patients with non-significant epicardial CAD and objective evidence of ischaemia.

10 Gaps in the evidence

10.1 Diagnosis and assessment

More information on the effects of various risk factors, biomarkers, and comorbidities on the PTP of obstructive CAD is needed. Adequately powered RCTs are needed to compare the effectiveness of different diagnostic strategies, and to evaluate how to best integrate diagnostic tests in patient care in terms of clinical outcomes and the use of healthcare resources.

10.2 Assessment of risk

Studies should address whether an initial invasive strategy, in addition to optimal medical therapy in patients with CCS and inducible ischaemia by non-invasive testing, improves outcomes. Larger trials are needed to verify the utility of systematic assessment of biomarkers in patients with suspected obstructive CAD.

10.3 Lifestyle management

Research regarding the most effective methods to support healthy lifestyle behaviours in brief or very brief clinical encounters, and sustain medication and lifestyle behaviour adherence over time, is needed. The cardiovascular effects of newer e-cigarettes over the long-term remain unknown, as does their effectiveness in smoking cessation.

The relative benefits of high-intensity interval training vs. moderate-intensity exercise in patients with CCS should be further evaluated. The benefits of decreasing sedentary behaviour, and the most appropriate 'dose' and type of physical activity in patients with CCS, are unknown, as are the effectiveness and cost-effectiveness of increasing cardiac rehabilitation participation among patients with CCS.

10.4 Pharmacological management

The need for and duration of beta-blocker therapy following MI to maintain a protective effect on cardiac events in the absence of LV systolic dysfunction are unknown.

In patients with CCS and without a previous MI, it remains to be determined whether current anti-ischaemic drugs improve prognosis.

Whether the initial use of second-line anti-ischaemic therapy (i.e. long-acting nitrates, ranolazine, nicorandil, ivabradine, or trimetazidine) alone or in combination with a first-line drug (i.e. beta-blocker or CCB) is superior to the combination of a beta-blocker with a CCB to control anginal symptoms and myocardial ischaemia in patients with CCS remains to be proven.

The efficacy and safety of aspirin or an alternative antithrombotic therapy in patients with a mild extent of atherosclerotic disease, such as that discovered by coronary CTA, requires further assessment, including the effect on cancer rates as well as cardiovascular events. The optimal long-term antithrombotic therapy, and strategies for individualizing this, in patients at high risk of ischaemic events is uncertain. Consequently, clinical studies comparing the efficacy and safety

of aspirin + P2Y₁₂ inhibitor with aspirin + factor Xa inhibitor are warranted to determine which subgroups may be preferentially treated with one or other strategy. The potential clinical benefit of ticagrelor monotherapy, while stopping aspirin, remains unproved at present.

The role of biomarkers in stratifying patients' risk of ischaemic events and bleeding requires clarification, including the role of growth differentiation factor-15 in guiding the risk of bleeding with DAPT. It is uncertain what effect novel lipid-lowering strategies will have on the net clinical benefit of DAPT, with similar implications of other strategies such as intensive BP lowering and, potentially in the future, selective anti-inflammatory therapies.

10.5 Revascularization

Further studies, including RCTs, are needed to assess the value of functional vs. anatomical guidance for CABG. The concept of complete revascularization and its effect on prognosis needs to be re-evaluated by prospective comparisons of functional vs. anatomical guidance for stenting on the one hand, and bypass on the other. Of note, none of the RCTs comparing PCI with CABG to date have used combined anatomical and functional guidance for PCI, a strategy that is suggested to significantly improve outcomes of PCI (Syntax II registry).

10.6 Heart failure and left ventricular dysfunction

Most of the evidence from RCTs supporting the recommendations for the use of drugs and devices in patients with chronic heart failure is based on cohorts with stable ischaemic heart disease and reduced LV function. However, patients with CCS requiring acute or chronic mechanical support are largely excluded from clinical trials, and the optimal management of such patients with drugs and devices during episodes of acute decompensation has not been adequately addressed.

10.7 Patients with long-standing diagnosis of chronic coronary syndromes

The incremental value of using risk scores to serially evaluate patients' risks, and more importantly to adjust the intensity of treatment, remains to be determined.

The optimal time intervals for serial visits remain to be determined.

10.8 Angina without obstructive coronary artery disease

Development of safe and efficacious novel pharmacological agents for this indication remains an unmet need.

10.9 Screening in asymptomatic subjects

Further studies on biomarkers and imaging tests for screening of CAD in asymptomatic subjects are needed. Furthermore, there are limited data on how to manage asymptomatic subjects who receive testing and have a positive test result, as evidence demonstrating improved prognosis following appropriate management is still lacking.

10.10 Comorbidities

The role of PCI in patients with aortic stenosis remains undetermined with respect to the indication for coronary revascularization and timing vs. valve intervention. Further information is needed on how to adapt cardiovascular therapies in patients with chronic inflammatory diseases.

10.11 Patients with refractory angina

Larger RCTs and registries are required to define the role of additional treatment modalities for specific subgroups, to decrease non-responder rates and ascertain benefit beyond potential placebo effects.

11 'What to do' and 'what not to do' messages from the Guidelines

Recommendations: 'what to do' and 'what not to do'	Class ^a	Level ^b
Basic biochemistry testing in the initial diagnostic management of patients with suspected CAD		
If evaluation suggests clinical instability or ACS, repeated measurements of troponin, preferably using high-sensitivity or ultrasensitive assays, are recommended to rule-out myocardial injury associated with ACS.	I	A
The following blood tests are recommended in all patients:		
● Full blood count (including haemoglobin);	I	B
● Creatinine measurement and estimation of renal function;	I	A
● A lipid profile (including LDL-C).	I	A
It is recommended that screening for type 2 diabetes mellitus in patients with suspected and established CCS is implemented with HbA1c and fasting plasma glucose measurements, and that an oral glucose tolerance test is added if HbA1c and fasting plasma glucose results are inconclusive.	I	B
Assessment of thyroid function is recommended in cases where there is clinical suspicion of thyroid disorders.	I	C
Resting ECG in the initial diagnostic management of patients with suspected CAD		
A resting 12 lead ECG is recommended in all patients with chest pain without obvious non-cardiac cause.	I	C
A resting 12 lead ECG is recommended in all patients during or immediately after an episode of angina suspected to indicate clinical instability of CAD.	I	C
ST-segment alterations recorded during supraventricular tachyarrhythmias should not be used as evidence of CAD.	III	C
Ambulatory ECG monitoring in the initial diagnostic management of patients with suspected CAD		
Ambulatory ECG monitoring is recommended in patients with chest pain and suspected arrhythmias.	I	C
Ambulatory ECG monitoring should not be used as routine examination in patients with suspected CCS.	III	C
Resting echocardiography and CMR in the initial diagnostic management of patients with suspected CAD		
A resting transthoracic echocardiogram is recommended in all patients for:	I	B
● Exclusion of alternative causes of angina;		
● Identification of regional wall motion abnormalities suggestive of CAD;		
● Measurement of LVEF for risk-stratification purposes;		
● Evaluation of diastolic function.		
Chest X-ray in the initial diagnostic management of patients with suspected CAD		
Chest X-ray is recommended for patients with an atypical presentation, signs and symptoms of heart failure, or suspicion of pulmonary disease.	I	C
Use of diagnostic imaging tests in the initial diagnostic management of symptomatic patients with suspected CAD		
Non-invasive functional imaging for myocardial ischaemia or coronary CTA is recommended as the initial test for diagnosing CAD in symptomatic patients in whom obstructive CAD cannot be excluded by clinical assessment alone.	I	B
It is recommended that selection of the initial non-invasive diagnostic test is done based on the clinical likelihood of CAD and other patient characteristics that influence test performance, local expertise, and the availability of tests.	I	C
Functional imaging for myocardial ischaemia is recommended if coronary CTA has shown CAD of uncertain functional significance or is not diagnostic.	I	B
Invasive angiography is recommended as an alternative test to diagnose CAD in patients with a high clinical likelihood and severe symptoms refractory to medical therapy, or typical angina at a low level of exercise and clinical evaluation that indicates high event risk. Invasive functional assessment must be available and used to evaluate stenoses before revascularization, unless very high grade (>90% diameter stenosis).	I	B

Continued

Coronary CTA is not recommended when extensive coronary calcification, irregular heart rate, significant obesity, inability to cooperate with breath-hold commands, or any other conditions makes good image quality unlikely.	III	C
Coronary calcium detection by computed tomography is not recommended to identify individuals with obstructive CAD.	III	C
Performing exercise ECG in the initial diagnostic management of patients with suspected CAD		
Exercise ECG is recommended for the assessment of exercise tolerance, symptoms, arrhythmias, BP response, and event risk in selected patients.	I	C
Recommendations for risk assessment		
Risk stratification is recommended based on clinical assessment and the result of the diagnostic test initially employed to make a diagnosis of CAD.	I	B
Resting echocardiography is recommended to quantify LV function in all patients with suspected CAD.	I	C
Risk stratification, preferably using stress imaging or coronary CTA (if local expertise and availability permit), or alternatively exercise stress ECG (if significant exercise can be performed and the ECG is amenable to the identification of ischaemic changes), is recommended in patients with suspected or newly diagnosed CAD.	I	B
In symptomatic patients with a high-risk clinical profile, ICA complemented by invasive physiological guidance (FFR) is recommended for cardiovascular risk stratification, particularly if the symptoms are inadequately responding to medical treatment and revascularization is considered for improvement of prognosis.	I	A
In patients with mild or no symptoms, ICA complemented by invasive physiological guidance (FFR/iwFR) is recommended for patients undergoing medical treatment in whom non-invasive risk stratification indicates a high event risk and revascularization is considered for the improvement of prognosis.	I	A
ICA is not recommended solely for risk stratification.	III	C
Recommendations on lifestyle management		
Improvement of lifestyle factors in addition to appropriate pharmacological management is recommended.	I	A
Cognitive behavioural interventions are recommended to help individuals achieve a healthy lifestyle.	I	A
Exercise-based cardiac rehabilitation is recommended as an effective means for patients with CCS to achieve a healthy lifestyle and manage risk factors.	I	A
Involvement of multidisciplinary healthcare professionals (cardiologists, GPs, nurses, dieticians, physiotherapists, psychologists, and pharmacists) is recommended.	I	A
Psychological interventions are recommended to improve symptoms of depression in patients with CCS.	I	B
Annual influenza vaccination is recommended for patients with CCS, especially in the elderly.	I	B
Recommendations on anti-ischaemic drugs in patients with CCS		
General considerations		
Medical treatment of symptomatic patients requires one or more drug(s) for angina/ischaemia relief in association with drug(s) for event prevention.	I	C
It is recommended that patients are educated about the disease, risk factors, and treatment strategy.	I	C
Timely review of the patient's response to medical therapies (e.g. 2–4 weeks after drug initiation) is recommended.	I	C
Angina/ischaemia relief		
Short-acting nitrates are recommended for immediate relief of effort angina.	I	B
First-line treatment is indicated with beta-blockers and/or CCBs to control heart rate and symptoms.	I	A
Nitrates are not recommended in patients with hypertrophic obstructive cardiomyopathy or co-administration of phosphodiesterase inhibitors.	III	B
Recommendations for event prevention		
Antithrombotic therapy in patients with CCS and in sinus rhythm		
Aspirin 75–100 mg daily is recommended in patients with a previous MI or revascularization.	I	A
Clopidogrel 75 mg daily is recommended as an alternative to aspirin in patients with aspirin intolerance.	I	B
Antithrombotic therapy post-PCI in patients with CCS and in sinus rhythm		
Aspirin 75–100 mg daily is recommended following stenting.	I	A
Clopidogrel 75 mg daily following appropriate loading (e.g. 600 mg, >5 days, or maintenance therapy) is recommended, in addition to aspirin, for 6 months following coronary stenting, irrespective of stent type, unless a shorter duration (1–3 months) is indicated due to the risk or occurrence of life-threatening bleeding.	I	A
Antithrombotic therapy in patients with CCS and AF		
When oral anticoagulation is initiated in a patient with AF who is eligible for a NOAC, a NOAC is recommended in preference to a VKA.	I	A
Long-term OAC therapy (a NOAC or VKA with time in therapeutic range >70%) is recommended in patients with AF and a CHA ₂ DS ₂ -VASc score ≥2 in males and ≥3 in females.	I	A

Continued

Antithrombotic therapy in post-PCI patients with AF or another indication for an OAC		
It is recommended that peri-procedural aspirin and clopidogrel are administered to patients undergoing coronary stent implantation.	I	C
In patients who are eligible for a NOAC, it is recommended that a NOAC (apixaban 5 mg b.i.d., dabigatran 150 mg b.i.d., edoxaban 60 mg o.d., or rivaroxaban 20 mg o.d.) is used in preference to a VKA in combination with antiplatelet therapy.	I	A
The use of ticagrelor or prasugrel is not recommended as part of triple antithrombotic therapy with aspirin and an OAC.	III	C
Use of proton pump inhibitors		
Concomitant use of a proton pump inhibitor is recommended in patients receiving aspirin monotherapy, DAPT, or OAC monotherapy who are at high risk of gastrointestinal bleeding.	I	A
Lipid-lowering drugs		
Statins are recommended in all patients with CCS.	I	A
If the goals are not achieved with the maximum tolerated dose of a statin, combination with ezetimibe is recommended.	I	B
For patients at very high risk who do not achieve their goal on a maximum tolerated dose of statin and ezetimibe, combination with a PCSK9 inhibitor is recommended.	I	A
ACE inhibitors		
ACE inhibitors (or ARBs) are recommended in the presence of other conditions (e.g. HF, hypertension, or diabetes).	I	A
Other drugs		
Beta-blockers are recommended in patients with LV dysfunction or systolic HF.	I	A
General recommendations for the management of patients with CCS and symptomatic HF due to ischaemic cardiomyopathy and LV systolic dysfunction		
Recommendations for drug therapy		
Diuretic therapy is recommended in symptomatic patients with signs of pulmonary or systemic congestion to relieve HF symptoms.	I	B
Beta-blockers are recommended as an essential component of treatment due to their efficacy in both relieving angina, and reducing morbidity and mortality in HF.	I	A
ACE inhibitor therapy is recommended in patients with symptomatic HF or asymptomatic LV dysfunction following MI, to improve symptoms and reduce morbidity and mortality.	I	A
An ARB is recommended as an alternative in patients who do not tolerate ACE inhibition or an angiotensin receptor-neprilysin inhibitor in patients with persistent symptoms despite optimal medical therapy.	I	B
An MRA is recommended in patients who remain symptomatic despite adequate treatment with an ACE inhibitor and beta-blocker to reduce morbidity and mortality.	I	A
For devices, comorbidities, and revascularization		
In patients with HF and bradycardia with high-degree atrioventricular block who require pacing, a CRT with a pacemaker rather than right ventricular pacing is recommended.	I	A
An implantable cardioverter-defibrillator is recommended in patients with documented ventricular dysrhythmia causing haemodynamic instability (secondary prevention), as well as in patients with symptomatic HF and an LVEF \leq 35%, to reduce the risk of sudden death and all-cause mortality.	I	A
CRT is recommended for symptomatic patients with HF in sinus rhythm with a QRS duration \geq 150 ms and LBBB QRS morphology, and with LVEF \leq 35% despite optimal medical therapy to improve symptoms and reduce morbidity and mortality. 355,356,383–392,353,354,381–390	I	A
CRT is recommended for symptomatic patients with HF in sinus rhythm with a QRS duration 130–149 ms and LBBB QRS morphology, and with LVEF \leq 35% despite optimal medical therapy to improve symptoms and reduce morbidity and mortality. 355,356,383–392,353,354,381–390	I	B
Comprehensive risk profiling and multidisciplinary management, including treatment of major comorbidities such as hypertension, hyperlipidaemia, diabetes, anaemia, and obesity, as well as smoking cessation and lifestyle modification, are recommended.	I	A
Myocardial revascularization is recommended when angina persists despite treatment with antianginal drugs.	I	A
Recommendations for patients with a long-standing diagnosis of CCS		
Asymptomatic patients		
A periodic visit to a cardiovascular healthcare professional is recommended to reassess potential changes in the risk status of patients, entailing clinical evaluation of lifestyle-modification measures, adherence to targets of cardiovascular risk factors, and the development of comorbidities that may affect treatments and outcomes.	I	C

Continued

In patients with mild or no symptoms receiving medical treatment, in whom non-invasive risk stratification indicates a high risk, and for whom revascularization is considered for improvement of prognosis, ICA (with FFR when necessary) is recommended.	I	C
Coronary CTA is not recommended as a routine follow-up test for patients with established CAD.	III	C
ICA is not recommended solely for risk stratification.	III	C
Symptomatic patients		
Reassessment of CAD status is recommended in patients with deteriorating LV systolic function that cannot be attributed to a reversible cause (e.g. long-standing tachycardia or myocarditis).	I	C
Risk stratification is recommended for patients with new or worsening symptom levels, preferably using stress imaging or, alternatively, exercise stress ECG.	I	B
It is recommended that patients with significant worsening of symptoms be expeditiously referred for evaluation.	I	C
ICA (with FFR/iwFR when necessary) is recommended for risk stratification in patients with severe CAD, particularly if the symptoms are refractory to medical treatment or if they have a high-risk clinical profile.	I	C
Investigations in patients with suspected vasospastic angina		
An ECG is recommended during angina if possible.	I	C
Invasive angiography or coronary CTA is recommended in patients with characteristic episodic resting angina and ST-segment changes, which resolve with nitrates and/or calcium antagonists, to determine the extent of underlying coronary disease.	I	C
Screening for CAD in asymptomatic subjects		
Total risk estimation using a risk-estimation system such as SCORE is recommended for asymptomatic adults aged >40 years without evidence of CVD, diabetes, CKD, or familial hypercholesterolaemia.	I	C
Assessment of family history of premature CVD (defined as a fatal or non-fatal CVD event, and/or established diagnosis of CVD in first-degree male relatives before 55 years of age or female relatives before 65 years of age) is recommended as part of cardiovascular risk assessment.	I	C
It is recommended that all individuals aged <50 years with a family history of premature CVD in a first-degree relative (<55 years of age in men, <65 years of age in women) are screened for familial hypercholesterolaemia using a validated clinical score.	I	B
Carotid ultrasound IMT for cardiovascular risk assessment is not recommended.	III	A
In low-risk non-diabetic asymptomatic adults, coronary CTA or functional imaging for ischaemia is not indicated for further diagnostic assessment.	III	C
Routine assessment of circulating biomarkers is not recommended for cardiovascular risk stratification.	III	B
Recommendations for hypertension treatment in CCS		
It is recommended that office BP be controlled to target values: systolic BP 120–130 mmHg in general and systolic BP 130–140 mmHg in older patients (aged >65 years).	I	A
In hypertensive patients with a recent MI, beta-blockers and RAS blockers are recommended.	I	A
In patients with symptomatic angina, beta-blockers and/or CCBs are recommended.	I	A
The combination of ACE inhibitors and an ARB is not recommended.	III	A
Recommendations for valvular disease in CCS		
ICA is recommended before valve surgery and any of the following: history of CVD, suspected myocardial ischaemia, LV systolic dysfunction, in men aged >40 years and post-menopausal women, or one or more cardiovascular risk factors.	I	C
ICA is recommended in the evaluation of moderate-to-severe functional mitral regurgitation.	I	C
In severe valvular heart disease, stress testing should not be routinely used to detect CAD because of the low diagnostic yield and potential risks.	III	C
Recommendations for active cancer in CCS		
Treatment decisions should be based on life expectancy, additional comorbidities such as thrombocytopenia, increased thrombosis propensity, and potential interactions between drugs used in CCS management and antineoplastic agents.	I	C
If revascularization is indicated in highly symptomatic patients with active cancer and increased frailty, the least invasive procedure is recommended.	I	C
Recommendations for diabetes mellitus in CCS		
Risk factor (BP, LDL-C, and HbA1c) control to targets is recommended in patients with CAD and diabetes mellitus.	I	A
In asymptomatic patients with diabetes mellitus, a periodic resting ECG is recommended for cardiovascular detection of conduction abnormalities, AF, and silent MI.	I	C

Continued

Treatment with ACE inhibitors is recommended in CCS patients with diabetes for event prevention.	I	B
The sodium-glucose co-transporter 2 inhibitors empagliflozin, canagliflozin, or dapagliflozin are recommended in patients with diabetes and CVD.	I	A
A glucagon-like peptide-1 receptor agonist (liraglutide or semaglutide) is recommended in patients with diabetes and CVD.	I	A
Recommendations for CKD in CCS		
It is recommended that risk factors are controlled to target values.	I	A
It is recommended that special attention be paid to potential dose adjustments of renally excreted drugs used in CCS.	I	C
It is recommended that the use of iodinated contrast agents is minimized in patients with severe CKD and preserved urine production to prevent further deterioration.	I	B
Recommendations for elderly patients with CCS		
It is recommended that particular attention is paid to side effects of drugs, intolerance, and overdosing in elderly patients.	I	C
The use of DES is recommended in elderly patients.	I	A
Radial access is recommended in elderly patients to reduce access-site bleeding complications.	I	B
It is recommended that diagnostic and revascularization decisions are based on symptoms, the extent of ischaemia, frailty, life expectancy, and comorbidities.	I	C
Recommendation for sex issues and CCS		
Hormone replacement therapy is not recommended for risk reduction in post-menopausal women.	III	C
Treatment options in refractory angina		
Transmyocardial revascularization is not recommended in patients with debilitating angina refractory to optimal medical and revascularization strategies.	III	A

ACE = angiotensin-converting enzyme; ACS = acute coronary syndromes; AF = atrial fibrillation; ARB = angiotensin receptor blocker; b.i.d. = bis in die (twice a day); BP = blood pressure; CHA₂DS₂-VASc = Cardiac failure, Hypertension, Age ≥75 [Doubled], Diabetes, Stroke [Doubled] – Vascular disease, Age 65–74 and Sex category [Female]; CAD = coronary artery disease; CCB = calcium channel blocker; CCS = chronic coronary syndromes; CKD = chronic kidney disease; CMR = cardiac magnetic resonance; CRT = cardiac resynchronization therapy; CTA = computed tomography angiography; CVD = cardiovascular disease; DAPT = dual antiplatelet therapy; DES = drug-eluting stent; ECG = electrocardiogram; FFR = fractional flow reserve; GPs = general practitioners; HbA1C = glycated haemoglobin; HF = heart failure; ICA = invasive coronary angiography; IMT = intima-media thickness; iwFR = instantaneous wave-free ratio (instant flow reserve); LBBB = left bundle branch block; LDL-C = low-density lipoprotein cholesterol; LV = left ventricular; LVEF = left ventricular ejection fraction; MI = myocardial infarction; MRA = mineralocorticoid receptor antagonist; NOAC = non-vitamin K antagonist oral anticoagulant; OAC = oral anticoagulant; o.d. = omni die (once a day); PCI = percutaneous coronary intervention; PCSK9 = proprotein convertase subtilisin-kexin type 9; RAS = renin-angiotensin system; VKA = vitamin K antagonist.

^aClass of recommendation.

^bLevel of evidence.

12 Supplementary data

Supplementary Data with additional Supplementary Tables and Figures complementing the full text—as well as section 3 on patients with angina and/or dyspnoea, and suspected coronary artery disease—are available on the *European Heart Journal* website and via the ESC website at www.escardio.org/guidelines.

13 Appendix

Author/Task Force Member affiliations:

Stephan Achenbach, Department of Cardiology, Friedrich-Alexander-Universität Erlangen-Nürnberg, Erlangen, Germany; **Stefan Agewall**, Department of Medicine, Clinical Science, Oslo, Norway; **Emanuele Barbato**, Advanced Biomedical Sciences, University Federico II, Naples, Italy; **Jeroen J. Bax**, Cardiology, Leiden University Medical Center, Leiden, Netherlands; **Davide Capodanno**, CardioThoracic-Vascular and Transplant Department, A.O.U. 'Policlinico-Vittorio Emanuele', University of Catania, Catania, Italy; **Thomas Cuisset**, Cardiology, CHU Timone, Marseille, France; **Christi Deaton**, Public Health and Primary Care, University of Cambridge School of Clinical Medicine, Cambridge, United Kingdom; **Kenneth Dickstein**, Cardiology, Stavanger University Hospital,

University of Bergen, Stavanger, Norway; **Thor Edvardsen**, Cardiology, Oslo University Hospital, Oslo, Norway; **Javier Escaned**, Interventional Cardiology Unit, Hospital Clinico San Carlos, Madrid, Spain; **Christian Funck-Brentano**, Department of Clinical Pharmacology, Sorbonne Université, AP-HP, ICAN and INSERM CIC Paris-Est, Paris, France; **Bernard J. Gersh**, Department of Cardiovascular Medicine, Mayo Clinic, Rochester, MN, United States of America; **Martine Gilard**, Cardiology, Brest University, Brest, France; **David Hasdai**, Cardiology, Rabin Medical Center Petah Tikva, Israel; **Robert Hatala**, Department of Cardiology and Angiology, Slovak Cardiovascular Institute, Slovak Medical University, Bratislava, Slovakia; **Felix Mahfoud**, Internal Medicine III, Saarland University, Homburg, Germany; **Josep Masip**, Cardiology Department /Intensive Care Department, Hospital CIMA-Sanitas/Consorci Sanitari Integral/ University of Barcelona, Barcelona, Spain; **Claudio Muneretto**, Cardiovascular Surgery, University of Brescia Medical School, Brescia, Italy; **Eva Prescott**, Department of Cardiology, Bispebjerg University Hospital, Copenhagen, Denmark; **Antti Saraste**, Heart Center, Turku University Hospital, Turku, Finland; **Robert F. Storey**, Department of Infection, Immunity and Cardiovascular Disease, University of Sheffield, Sheffield, United Kingdom; **Pavel Svtil**, Cardiology Practice, Practice of General Cardiology, Jihlava, Czech Republic; **Marco Valgimigli**, Inselspital, University of Bern, Bern, Switzerland.

ESC Committee for Practice Guidelines (CPG): Stephan Windecker (Chairperson) (Switzerland), Victor Aboyans (France), Colin Baigent (United Kingdom), Jean-Philippe Collet (France), Veronica Dean (France), Victoria Delgado (Netherlands), Donna Fitzsimons (United Kingdom), Christopher P. Gale (United Kingdom), Diederick E. Grobbee (Netherlands), Sigrun Halvorsen (Norway), Gerhard Hindricks (Germany), Bernard Jung (France), Peter Jüni (Canada), Hugo A. Katus (Germany), Ulf Landmesser (Germany), Christophe Leclercq (France), Maddalena Lettino (Italy), Basil S. Lewis (Israel), Bela Merkely (Hungary), Christian Mueller (Switzerland), Steffen Petersen (United Kingdom), Anna Sonia Petronio (Italy), Dimitrios J. Richter (Greece), Marco Roffi (Switzerland), Evgeny Shlyakhto (Russian Federation), Iain A. Simpson (United Kingdom), Miguel Sousa-Uva (Portugal), Rhian M. Touyz (United Kingdom).

ESC National Cardiac Societies actively involved in the review process of the 2019 ESC Guidelines for the diagnosis and management of chronic coronary syndromes.

Algeria: Algerian Society of Cardiology, Salim Benkhedda; **Austria:** Austrian Society of Cardiology, Bernhard Metzler; **Belarus:** Belorussian Scientific Society of Cardiologists, Volha Sujayeva; **Belgium:** Belgian Society of Cardiology, Bernard Cosyns; **Bosnia and Herzegovina:** Association of Cardiologists of Bosnia and Herzegovina, Zumreta Kusljagic; **Bulgaria:** Bulgarian Society of Cardiology, Vasil Velchev; **Cyprus:** Cyprus Society of Cardiology, Georgios Panayi; **Czech Republic:** Czech Society of Cardiology, Petr Kala; **Denmark:** Danish Society of Cardiology, Sune Ammentorp Haahr-Pedersen; **Egypt:** Egyptian Society of Cardiology, Hamza Kabil; **Estonia:** Estonian Society of Cardiology, Tiia Ainla; **Finland:** Finnish Cardiac Society, Tomi Kaukonen; **France:** French Society of Cardiology, Guillaume Cayla; **Georgia:** Georgian Society of Cardiology, Zurab Pagava; **Germany:** German Cardiac Society, Jochen Woehrl; **Greece:** Hellenic Society of Cardiology, John Kanakakis; **Hungary:** Hungarian Society of Cardiology, Kálmán Tóth; **Iceland:** Icelandic Society of Cardiology, Thorarinn Gudnason; **Ireland:** Irish Cardiac Society, Aaron Peace; **Israel:** Israel Heart Society, Doron Aronson; **Italy:** Italian Federation of Cardiology, Carmine Riccio; **Kosovo (Republic of):** Kosovo Society of Cardiology, Shpend Elezi; **Kyrgyzstan:** Kyrgyz Society of Cardiology, Erkin Mirrakhimov; **Latvia:** Latvian Society of Cardiology, Silvija Hansone; **Lebanon:** Lebanese Society of Cardiology, Antoine Sarkis; **Lithuania:** Lithuanian Society of Cardiology, Ruta Babarskiene; **Luxembourg:** Luxembourg Society of Cardiology, Jean Beissel; **Malta:** Maltese Cardiac Society, Andrew J. Cassar Maempel; **Moldova (Republic of):** Moldavian Society of Cardiology, Valeriu Revenco; **Netherlands:** Netherlands Society of Cardiology, G.J. de Grooth; **North Macedonia:** Macedonian FYR Society of Cardiology, Hristo Pejkov; **Norway:** Norwegian Society of Cardiology, Vibeke Juliebø; **Poland:** Polish Cardiac Society, Piotr Lipiec; **Portugal:** Portuguese Society of Cardiology, José Santos; **Romania:** Romanian Society of Cardiology, Ovidiu Chioncel; **Russian Federation:** Russian Society of Cardiology, Dmitry Duplyakov; **San Marino:** San Marino Society of Cardiology, Luca Bertelli; **Serbia:** Cardiology Society of Serbia, Ana Djordjevic

Dikic; **Slovakia:** Slovak Society of Cardiology, Martin Studenčan; **Slovenia:** Slovenian Society of Cardiology, Matjaz Bunc; **Spain:** Spanish Society of Cardiology, Fernando Alfonso; **Sweden:** Swedish Society of Cardiology, Magnus Bäck; **Switzerland:** Swiss Society of Cardiology, Michael Zellweger; **Tunisia:** Tunisian Society of Cardiology and Cardio-Vascular Surgery, Faouzi Addad; **Turkey:** Turkish Society of Cardiology, Aylin Yildirim; **Ukraine:** Ukrainian Association of Cardiology, Yuriy Sirenko; **United Kingdom of Great Britain and Northern Ireland:** British Cardiovascular Society, Brian Clapp.

14 References

- Williams RP, Manou-Stathopoulou V, Redwood SR, Marber MS. 'Warm-up Angina': harnessing the benefits of exercise and myocardial ischaemia. *Heart* 2014;**100**:106–114.
- Diamond GA. A clinically relevant classification of chest discomfort. *J Am Coll Cardiol* 1983;**1**:574–575.
- Genders TS, Steyerberg EW, Hunink MG, Nieman K, Galema TW, Mollet NR, de Feyter PJ, Krestin GP, Alkadhi H, Leschka S, Desbiolles L, Meijs MF, Cramer MJ, Knuuti J, Kajander S, Bogaert J, Goetschalckx K, Cademartiri F, Maffei E, Martini C, Seitun S, Aldrovandi A, Wildermuth S, Stinn B, Fornaro J, Feuchtner G, De Zordo T, Auer T, Plank F, Friedrich G, Pugliese F, Petersen SE, Davies LC, Schoepf UJ, Rowe GW, van Mieghem CA, van Driessche L, Sinityn V, Gopalan D, Nikolaou K, Bamberg F, Cury RC, Battle J, Maurovich-Horvat P, Bartykowska A, Merkely B, Becker D, Hadamitzky M, Hausleiter J, Dewey M, Zimmermann E, Laule M. Prediction model to estimate presence of coronary artery disease: retrospective pooled analysis of existing cohorts. *BMJ* 2012;**344**:e3485.
- Douglas PS, Hoffmann U, Patel MR, Mark DB, Al-Khalidi HR, Cavanaugh B, Cole J, Dolor RJ, Fordyce CB, Huang M, Khan MA, Kosinski AS, Krucoff MW, Malhotra V, Picard MH, Udelson JE, Velazquez EJ, Yow E, Cooper LS, Lee KL; PROMISE Investigators. Outcomes of anatomical versus functional testing for coronary artery disease. *N Engl J Med* 2015;**372**:1291–1300.
- SCOT-HEART investigators. CT coronary angiography in patients with suspected angina due to coronary heart disease (SCOT-HEART): an open-label, parallel-group, multicentre trial. *Lancet* 2015;**385**:2383–2391.
- SCOT-HEART investigators, Newby DE, Adamson PD, Berry C, Boon NA, Dweck MR, Flather M, Forbes J, Hunter A, Lewis S, MacLean S, Mills NL, Norrie J, Roditi G, Shah ASV, Timmis AD, van Beek EJ, Williams MC. Coronary CT angiography and 5-year risk of myocardial infarction. *N Engl J Med* 2018;**379**:924–933.
- Reeh J, Thering CB, Heitmann M, Hojberg S, Sorum C, Bech J, Husum D, Dominguez H, Sehestedt T, Hermann T, Hansen KW, Simonsen L, Galatius S, Prescott E. Prediction of obstructive coronary artery disease and prognosis in patients with suspected stable angina. *Eur Heart J* 2018;**40**:1426–1435.
- Cheng VY, Berman DS, Rozanski A, Dunning AM, Achenbach S, Al-Mallah M, Budoff MJ, Cademartiri F, Callister TQ, Chang HJ, Chinnaiyan K, Chow BJ, Delago A, Gomez M, Hadamitzky M, Hausleiter J, Karlsberg RP, Kaufmann P, Lin FY, Maffei E, Raff GL, Villines TC, Shaw LJ, Min JK. Performance of the traditional age, sex, and angina typicality-based approach for estimating pretest probability of angiographically significant coronary artery disease in patients undergoing coronary computed tomographic angiography: results from the multinational coronary CT angiography evaluation for clinical outcomes: an international multicenter registry (CONFIRM). *Circulation* 2011;**124**:2423–2432, 2421–2428.
- Campeau L. Letter: Grading of angina pectoris. *Circulation* 1976;**54**:522–523.
- Bosner S, Haasenritter J, Becker A, Karatolios K, Vaucher P, Gencer B, Herzig L, Heinzl-Gutenbrunner M, Schaefer JR, Abu Hani M, Keller H, Sonnichsen AC, Baum E, Donner-Banzhoff N. Ruling out coronary artery disease in primary care: development and validation of a simple prediction rule. *CMAJ* 2010;**182**:1295–1300.
- Roffi M, Patrono C, Collet JP, Mueller C, Valgimigli M, Andreotti F, Bax JJ, Borger MA, Brotons C, Chew DP, Gencer B, Hasenfuss G, Kjeldsen K, Lancellotti P, Landmesser U, Mehilli J, Mukherjee D, Storey RF, Windecker S. 2015 ESC Guidelines for the management of acute coronary syndromes in patients presenting without persistent ST-segment elevation: Task Force for the Management of Acute Coronary Syndromes in Patients Presenting without Persistent ST-Segment Elevation of the European Society of Cardiology (ESC). *Eur Heart J* 2016;**37**:267–315.
- Ibanez B, James S, Agewall S, Antunes MJ, Bucciarelli-Ducci C, Bueno H, Caforio ALP, Cremonesi F, Deaton C, Delgado-García JM, Halvorsen S, Hindricks G, Kastrati A, Lenzen MJ, Prescott E, Roffi M, Valgimigli M, Varenhorst C, Vranckx P, Widimsky P. 2017 ESC Guidelines for the management of acute myocardial infarction in patients presenting with ST-segment elevation: The Task Force for the management of

- acute myocardial infarction in patients presenting with ST-segment elevation of the *European Society of Cardiology (ESC)*. *Eur Heart J* 2018;**39**:119–177.
13. Patel MR, Peterson ED, Dai D, Brennan JM, Redberg RF, Anderson HV, Brindis RG, Douglas PS. Low diagnostic yield of elective coronary angiography. *N Engl J Med* 2010;**362**:886–895.
 14. Jespersen L, Hvelplund A, Abildstrom SZ, Pedersen F, Galatius S, Madsen JK, Jorgensen E, Kelbaek H, Prescott E. Stable angina pectoris with no obstructive coronary artery disease is associated with increased risks of major adverse cardiovascular events. *Eur Heart J* 2012;**33**:734–744.
 15. Piepoli MF, Hoes AW, Agewall S, Albus C, Brotons C, Catapano AL, Cooney MT, Corra U, Cosyns B, Deaton C, Graham I, Hall MS, Hobbs FDR, Lochan ML, Lollgen H, Marques-Vidal P, Perk J, Prescott E, Redon J, Richter DJ, Sattar N, Smulders Y, Tiberi M, van der Worp HB, van Dis I, Verschuren WMM, Binno S. 2016 European Guidelines on cardiovascular disease prevention in clinical practice: The Sixth Joint Task Force of the European Society of Cardiology and Other Societies on Cardiovascular Disease Prevention in Clinical Practice (constituted by representatives of 10 societies and by invited experts) Developed with the special contribution of the European Association for Cardiovascular Prevention & Rehabilitation (EACPR). *Eur Heart J* 2016;**37**:2315–2381.
 16. 2019 ESC/EASD Guidelines on diabetes, pre-diabetes, and cardiovascular diseases. *Eur Heart J* 2019;In press.
 17. Catapano AL, Graham I, De Backer G, Wiklund O, Chapman MJ, Drexel H, Hoes AW, Jennings CS, Landmesser U, Pedersen TR, Reiner Z, Riccardi G, Taskinen MR, Tokgozogl L, Verschuren WMM, Vlachopoulos C, Wood DA, Zamorano JL, Cooney MT. 2016 ESC/EAS Guidelines for the management of dyslipidaemias. *Eur Heart J* 2016;**37**:2999–3058.
 18. Di Angelantonio E, Chowdhury R, Sarwar N, Aspelund T, Danesh J, Gudnason V. Chronic kidney disease and risk of major cardiovascular disease and non-vascular mortality: prospective population based cohort study. *BMJ* 2010;**341**:c4986.
 19. Nitsch D, Grams M, Sang Y, Black C, Cirillo M, Djurdjev O, Iseki K, Jassal SK, Kimm H, Kronenberg F, Oien CM, Levey AS, Levin A, Woodward M, Hemmelgarn BR; Chronic Kidney Disease Prognosis Consortium. Associations of estimated glomerular filtration rate and albuminuria with mortality and renal failure by sex: a meta-analysis. *BMJ* 2013;**346**:f324.
 20. Lopes NH, da Silva Paulitsch F, Pereira A, Garzillo CL, Ferreira JF, Stolf N, Hueb W. Mild chronic kidney dysfunction and treatment strategies for stable coronary artery disease. *J Thorac Cardiovasc Surg* 2009;**137**:1443–1449.
 21. Omland T, Pfeffer MA, Solomon SD, de Lemos JA, Røsjø H, Šaltytė Benth J, Maggioni A, Domanski MJ, Rouleau JL, Sabatine MS, Braunwald E; PEACE Investigators. Prognostic value of cardiac troponin I measured with a highly sensitive assay in patients with stable coronary artery disease. *J Am Coll Cardiol* 2013;**61**:1240–1249.
 22. Omland T, de Lemos JA, Sabatine MS, Christophi CA, Rice MM, Jablonski KA, Tjora S, Domanski MJ, Gersh BJ, Rouleau JL, Pfeffer MA, Braunwald E. Prevention of Events with Angiotensin Converting Enzyme Inhibition (PEACE) Trial Investigators. A sensitive cardiac troponin T assay in stable coronary artery disease. *N Engl J Med* 2009;**361**:2538–2547.
 23. Everett BM, Brooks MM, Vlachos HE, Chaitman BR, Frye RL, Bhatt DL; BARI 2D Study Group. Troponin and cardiac events in stable ischemic heart disease and diabetes. *N Engl J Med* 2015;**373**:610–620.
 24. de Lemos JA, Drazner MH, Omland T, Ayers CR, Khera A, Rohatgi A, Hashim I, Berry JD, Das SR, Morrow DA, McGuire DK. Association of troponin T detected with a highly sensitive assay and cardiac structure and mortality risk in the general population. *JAMA* 2010;**304**:2503–2512.
 25. van Holten TC, Waanders LF, de Groot PG, Vissers J, Hoefer IE, Pasterkamp G, Prins MW, Roest M. Circulating biomarkers for predicting cardiovascular disease risk: a systematic review and comprehensive overview of meta-analyses. *PLoS One* 2013;**8**:e62080.
 26. Madsen DM, Diederichsen ACP, Hosbond SE, Gerke O, Mickley H. Diagnostic and prognostic value of a careful symptom evaluation and high sensitive troponin in patients with suspected stable angina pectoris without prior cardiovascular disease. *Atherosclerosis* 2017;**258**:131–137.
 27. Laufer EM, Mingels AM, Winkens MH, Joosen IA, Schellings MW, Leiner T, Wildberger JE, Narula J, Van Dieijen-Visser MP, Hofstra L. The extent of coronary atherosclerosis is associated with increasing circulating levels of high sensitive cardiac troponin T. *Arterioscler Thromb Vasc Biol* 2010;**30**:1269–1275.
 28. Reichlin T, Hochholzer W, Bassetti S, Steuer S, Stelzig C, Hartwiger S, Biedert S, Schaub N, Buergle C, Potocki M, Noveman M, Breidhardt T, Twerenbold R, Winkler K, Bingisser R, Mueller C. Early diagnosis of myocardial infarction with sensitive cardiac troponin assays. *N Engl J Med* 2009;**361**:858–867.
 29. Keller T, Zeller T, Peetz D, Tzikas S, Roth A, Czyn E, Bickel C, Baldus S, Warnholtz A, Frohlich M, Sinnig CR, Eleftheriadis MS, Wild PS, Schnabel RB, Lubos E, Jachmann N, Genth-Zotz S, Post F, Nicaud V, Tiret L, Lackner KJ, Munzel TF, Blankenberg S. Sensitive troponin I assay in early diagnosis of acute myocardial infarction. *N Engl J Med* 2009;**361**:868–877.
 30. da Silveira AD, Ribeiro RA, Rossini AP, Stella SF, Ritta HA, Stein R, Polanczyk CA. Association of anemia with clinical outcomes in stable coronary artery disease. *Coron Artery Dis* 2008;**19**:21–26.
 31. Di Angelantonio E, Danesh J, Eiriksdottir G, Gudnason V. Renal function and risk of coronary heart disease in general populations: new prospective study and systematic review. *PLoS Med* 2007;**4**:e270.
 32. Shlipak MG, Matsushita K, Arnlöv J, Inker LA, Katz R, Polkinghorne KR, Rothenbacher D, Sarnak MJ, Astor BC, Coresh J, Levey AS, Gansevoort RT; Prognosis Consortium CKD. Cystatin C versus creatinine in determining risk based on kidney function. *N Engl J Med* 2013;**369**:932–943.
 33. Silverman MG, Ference BA, Im K, Wiviott SD, Giugliano RP, Grundy SM, Braunwald E, Sabatine MS. Association between lowering LDL-C and cardiovascular risk reduction among different therapeutic interventions: a systematic review and meta-analysis. *JAMA* 2016;**316**:1289–1297.
 34. Cholesterol Treatment Trialists' (CTT) Collaboration, Fulcher J, O'Connell R, Voysey M, Emberson J, Blackwell L, Mihaylova B, Simes J, Collins R, Kirby A, Colhoun H, Braunwald E, La Rosa J, Pedersen TR, Tonkin A, Davis B, Sleight P, Franzosi MG, Baigent C, Keech A. Efficacy and safety of LDL-lowering therapy among men and women: meta-analysis of individual data from 174,000 participants in 27 randomised trials. *Lancet* 2015;**385**:1397–1405.
 35. Bartnik M, Ryden L, Malmberg K, Ohrvik J, Pyörälä K, Standl E, Ferrari R, Simoons M, Soler-Soler J; Euro Heart Survey Investigators. Oral glucose tolerance test is needed for appropriate classification of glucose regulation in patients with coronary artery disease: a report from the Euro Heart Survey on Diabetes and the Heart. *Heart* 2007;**93**:72–77.
 36. Cohn PF, Fox KM, Daly C. Silent myocardial ischemia. *Circulation* 2003;**108**:1263–1277.
 37. Androulakis A, Aznaouridis KA, Aggeli CJ, Roussakis GN, Michaelides AP, Kartalis AN, Stogiannos PN, Dilaveris PE, Misovoulos PI, Stefanadis CI, Kallikazaros IE. Transient ST-segment depression during paroxysms of atrial fibrillation in otherwise normal individuals: relation with underlying coronary artery disease. *J Am Coll Cardiol* 2007;**50**:1909–1911.
 38. Guo Y, Zhang L, Wang C, Zhao Y, Chen W, Gao M, Zhu P, Yang T, Wang Y. Medical treatment and long-term outcome of chronic atrial fibrillation in the aged with chest distress: a retrospective analysis versus sinus rhythm. *Clin Interv Aging* 2011;**6**:193–198.
 39. Nucifora G, Schuij JD, van Werkhoven JM, Trines SA, Kajander S, Tops LF, Turta O, Jukema JW, Schreur JH, Heijnenbroek MW, Gaemperli O, Kaufmann PA, Knuuti J, van der Wall EE, Schalij MJ, Bax JJ. Relationship between obstructive coronary artery disease and abnormal stress testing in patients with paroxysmal or persistent atrial fibrillation. *Int J Cardiovasc Imaging* 2011;**27**:777–785.
 40. Pradhan R, Chaudhary A, Donato AA. Predictive accuracy of ST depression during rapid atrial fibrillation on the presence of obstructive coronary artery disease. *Am J Emerg Med* 2012;**30**:1042–1047.
 41. Forslund L, Hjerdahl P, Held C, Björkander I, Eriksson SV, Rehnqvist N. Ischaemia during exercise and ambulatory monitoring in patients with stable angina pectoris and healthy controls. Gender differences and relationships to catecholamines. *Eur Heart J* 1998;**19**:578–587.
 42. Davies RF, Goldberg AD, Forman S, Pepine CJ, Knatterud GL, Geller N, Sopko G, Pratt C, Deanfield J, Conti CR. Asymptomatic Cardiac Ischemia Pilot (ACIP) study two-year follow-up: outcomes of patients randomized to initial strategies of medical therapy versus revascularization. *Circulation* 1997;**95**:2037–2043.
 43. Stone PH, Chaitman BR, Forman S, Andrews TC, Bittner V, Bourassa MG, Davies RF, Deanfield JE, Frishman W, Goldberg AD, MacCallum G, Ouyang P, Pepine CJ, Pratt CM, Sharaf B, Steingart R, Knatterud GL, Sopko G, Conti CR. Prognostic significance of myocardial ischemia detected by ambulatory electrocardiography, exercise treadmill testing, and electrocardiogram at rest to predict cardiac events by one year (the Asymptomatic Cardiac Ischemia Pilot [ACIP] study). *Am J Cardiol* 1997;**80**:1395–1401.
 44. Daly C, Norrie J, Murdoch DL, Ford I, Dargie HJ, Fox K; TIBET (Total Ischaemic Burden European Trial) study group. The value of routine non-invasive tests to predict clinical outcome in stable angina. *Eur Heart J* 2003;**24**:532–540.
 45. Daly CA, De Stavola B, Sendon JL, Tavazzi L, Boersma E, Clemens F, Danchin N, Delahaye F, Gitt A, Julian D, Mulcahy D, Ruzyllo W, Thygesen K, Verheugt F, Fox KM; Euro Heart Survey Investigators. Predicting prognosis in stable angina—results from the Euro heart survey of stable angina: prospective observational study. *BMJ* 2006;**332**:262–267.
 46. Cerqueira MD, Weissman NJ, Dilsizian V, Jacobs AK, Kaul S, Laskey WK, Pennell DJ, Rumberger JA, Ryan T, Verani MS; American Heart Association Writing Group on Myocardial Segmentation and Registration for Cardiac Imaging. Standardized myocardial segmentation and nomenclature for tomographic imaging of the heart. A statement for healthcare professionals from the Cardiac Imaging Committee of the Council on Clinical Cardiology of the American Heart Association. *Circulation* 2002;**105**:539–542.
 47. Eek C, Grenne B, Brunvand H, Aakhus S, Endresen K, Hol PK, Smith HJ, Smiseth OA, Edvardsen T, Skulstad H. Strain echocardiography and wall motion score

- index predicts final infarct size in patients with non-ST-segment-elevation myocardial infarction. *Circ Cardiovasc Imaging* 2010;**3**:187–194.
48. Smedsrud MK, Sarvari S, Haugaa KH, Gjesdal O, Orn S, Aaberge L, Smiseth OA, Edvardsen T. Duration of myocardial early systolic lengthening predicts the presence of significant coronary artery disease. *J Am Coll Cardiol* 2012;**60**:1086–1093.
 49. Smedsrud MK, Gravingn J, Omland T, Eek C, Morkrid L, Skulstad H, Aaberge L, Bendz B, Kjekshus J, Edvardsen T. Sensitive cardiac troponins and N-terminal pro-B-type natriuretic peptide in stable coronary artery disease: correlation with left ventricular function as assessed by myocardial strain. *Int J Cardiovasc Imaging* 2015;**31**:967–973.
 50. Biering-Sorensen T, Hoffmann S, Mogelvang R, Zeeberg Iversen A, Galatius S, Fritz-Hansen T, Bech J, Jensen JS. Myocardial strain analysis by 2-dimensional speckle tracking echocardiography improves diagnostics of coronary artery stenosis in stable angina pectoris. *Circ Cardiovasc Imaging* 2014;**7**:58–65.
 51. Shaw LJ, Bugiardini R, Merz CN. Women and ischemic heart disease: evolving knowledge. *J Am Coll Cardiol* 2009;**54**:1561–1575.
 52. Nagueh SF, Smiseth OA, Appleton CP, Byrd BF III, Dokainish H, Edvardsen T, Flachskampf FA, Gillebert TC, Klein AL, Lancellotti P, Marino P, Oh JK, Alexandru Popescu B, Waggoner AD. Recommendations for the evaluation of left ventricular diastolic function by echocardiography: an update from the American Society of Echocardiography and the European Association of Cardiovascular Imaging. *Eur Heart J Cardiovasc Imaging* 2016;**17**:1321–1360.
 53. Steeds RP, Garbi M, Cardim N, Kasprzak JD, Sade E, Nihoyannopoulos P, Popescu BA, Stefanidis A, Cosyns B, Monaghan M, Aakhus S, Edvardsen T, Flachskampf F, Galiuto L, Athanassopoulos G, Lancellotti P; 2014–2016 EACVI Scientific Documents Committee. EACVI appropriateness criteria for the use of transthoracic echocardiography in adults: a report of literature and current practice review. *Eur Heart J Cardiovasc Imaging* 2017;**18**:1191–1204.
 54. Senior R, Becher H, Monaghan M, Agati L, Zamorano J, Vanoverschelde JL, Nihoyannopoulos P, Edvardsen T, Lancellotti P; EACVI Scientific Documents Committee for 2014–16 and 2016–18. Clinical practice of contrast echocardiography: recommendation by the European Association of Cardiovascular Imaging (EACVI) 2017. *Eur Heart J Cardiovasc Imaging* 2017;**18**:1205–1205af.
 55. Greenwood JP, Ripley DP, Berry C, McCann GP, Plein S, Bucciarelli-Ducci C, Dall'Armellina E, Prasad A, Bijsterveld P, Foley JR, Mangion K, Sculpher M, Walker S, Everett CC, Cairns DA, Sharples LD, Brown JM; CE-MARC 2 Investigators. Effect of care guided by cardiovascular magnetic resonance, myocardial perfusion scintigraphy, or NICE guidelines on subsequent unnecessary angiography rates: the CE-MARC 2 randomized clinical trial. *JAMA* 2016;**316**:1051–1060.
 56. Motwani M, Swoboda PP, Plein S, Greenwood JP. Role of cardiovascular magnetic resonance in the management of patients with stable coronary artery disease. *Heart* 2018;**104**:888–894.
 57. Kim RJ, Wu E, Rafael A, Chen EL, Parker MA, Simonetti O, Klocke FJ, Bonow RO, Judd RM. The use of contrast-enhanced magnetic resonance imaging to identify reversible myocardial dysfunction. *N Engl J Med* 2000;**343**:1445–1453.
 58. Vitarelli A, Tiukinhoy S, Di Luzio S, Zampino M, Gheorghiadu M. The role of echocardiography in the diagnosis and management of heart failure. *Heart Fail Rev* 2003;**8**:181–189.
 59. Diamond GA, Forrester JS. Analysis of probability as an aid in the clinical diagnosis of coronary-artery disease. *N Engl J Med* 1979;**300**:1350–1358.
 60. Montalescot G, Sechtem U, Achenbach S, Andreotti F, Arden C, Budaj A, Bugiardini R, Crea F, Cuisset T, Di Mario C, Ferreiras JR, Gersh BJ, Gitt AK, Hulot JS, Marx N, Opie LH, Pfisterer M, Prescott E, Ruschitzka F, Sabate M, Senior R, Taggart DP, van der Wall EE, Vrints CJ. 2013 ESC guidelines on the management of stable coronary artery disease: the Task Force on the management of stable coronary artery disease of the European Society of Cardiology. *Eur Heart J* 2013;**34**:2949–3003.
 61. Genders TS, Steyerberg EW, Alkadhi H, Leschka S, Desbiolles L, Nieman K, Galema TW, Meijboom WB, Mollet NR, de Feyter PJ, Cademartiri F, Maffei E, Dewey M, Zimmermann E, Laule M, Pugliese F, Barbagallo R, Sinitsyn V, Bogaert J, Goetschalckx K, Schoepf UJ, Rowe GW, Schuijf JD, Bax JJ, de Graaf FR, Knuuti J, Kajander S, van Mieghem CA, Meijis MF, Cramer MJ, Gopalan D, Feuchtner G, Friedrich G, Krestin GP, Hunink MG, CAD Consortium. A clinical prediction rule for the diagnosis of coronary artery disease: validation, updating, and extension. *Eur Heart J* 2011;**32**:1316–1330.
 62. Foldyna B, Udelson JE, Karady J, Banerji D, Lu MT, Mayrhofer T, Bittner DO, Meyersohn NM, Emami H, Genders TSS, Fordyce CB, Ferencik M, Douglas PS, Hoffmann U. Pretest probability for patients with suspected obstructive coronary artery disease: re-evaluating Diamond-Forrester for the contemporary era and clinical implications: insights from the PROMISE trial. *Eur Heart J Cardiovasc Imaging* 2018;**20**:574–581.
 63. Adamson PD, Newby DE, Hill CL, Coles A, Douglas PS, Fordyce CB. Comparison of international guidelines for assessment of suspected stable angina: insights from the PROMISE and SCOT-HEART. *JACC Cardiovasc Imaging* 2018;**11**:1301–1310.
 64. Juarez-Orozco LE, Saraste A, Capodanno D, Prescott E, Ballo H, Bax JJ, Wijns W, Knuuti J. Impact of a decreasing pre-test probability on the performance of diagnostic tests for coronary artery disease. *Eur Heart J Cardiovasc Imaging* 2019;doi: 10.1093/ehjci/jez054.
 65. Versteilen MO, Joosen IA, Shaw LJ, Narula J, Hofstra L. Comparison of Framingham, PROCAM, SCORE, and Diamond Forrester to predict coronary atherosclerosis and cardiovascular events. *J Nucl Cardiol* 2011;**18**:904–911.
 66. Fordyce CB, Douglas PS, Roberts RS, Hoffmann U, Al-Khalidi HR, Patel MR, Granger CB, Kostis J, Mark DB, Lee KL, Udelson JE; PROMISE Investigators. Identification of patients with stable chest pain deriving minimal value from non-invasive testing: the PROMISE minimal-risk tool, a secondary analysis of a randomized clinical trial. *JAMA Cardiol* 2017;**2**:400–408.
 67. Jensen JM, Voss M, Hansen VB, Andersen LK, Johansen PB, Munkholm H, Norgaard BL. Risk stratification of patients suspected of coronary artery disease: comparison of five different models. *Atherosclerosis* 2012;**220**:557–562.
 68. Sharma A, Sekaran NK, Coles A, Pagidipati NJ, Hoffmann U, Mark DB, Lee KL, Al-Khalidi HR, Lu MT, Pellikka PA, Trong QA, Douglas PS. Impact of diabetes mellitus on the evaluation of stable chest pain patients: insights from the PROMISE (Prospective Multicenter Imaging Study for Evaluation of Chest Pain) trial. *J Am Heart Assoc* 2017;**6**:e007019.
 69. Budoff MJ, Mayrhofer T, Ferencik M, Bittner D, Lee KL, Lu MT, Coles A, Jang J, Krishnam M, Douglas PS, Hoffmann U; PROMISE Investigators. Prognostic value of coronary artery calcium in the PROMISE study (Prospective Multicenter Imaging Study for Evaluation of Chest Pain). *Circulation* 2017;**136**:1993–2002.
 70. Villines TC, Hulten EA, Shaw LJ, Goyal M, Dunning A, Achenbach S, Al-Mallah M, Berman DS, Budoff MJ, Cademartiri F, Callister TQ, Chang HJ, Cheng VY, Chinnaiyan K, Chow BJ, Delago A, Hadamitzky M, Hausleiter J, Kaufmann P, Lin FY, Maffei E, Raff GL, Min JK; CONFIRM Registry Investigators. Prevalence and severity of coronary artery disease and adverse events among symptomatic patients with coronary artery calcification scores of zero undergoing coronary computed tomography angiography: results from the CONFIRM (Coronary CT Angiography Evaluation for Clinical Outcomes: An International Multicenter) registry. *J Am Coll Cardiol* 2011;**58**:2533–2540.
 71. De Bruyne B, Pijls NH, Kalesan B, Barbato E, Tonino PA, Piroth Z, Jagic N, Mobius-Winkler S, Rioufol G, Witt N, Kala P, MacCarthy P, Engstrom T, Oldroyd KG, Mavromatis K, Manoharan G, Verlee P, Frobert O, Curzen N, Johnson JB, Juni P, Fearon WF; FAME 2 Trial Investigators. Fractional flow reserve-guided PCI versus medical therapy in stable coronary disease. *N Engl J Med* 2012;**367**:991–1001.
 72. Tonino PA, De Bruyne B, Pijls NH, Siebert U, Ikeno F, van't Veer M, Klauss V, Manoharan G, Engstrom T, Oldroyd KG, Ver Lee PN, MacCarthy PA, Fearon WF; FAME Study Investigators. Fractional flow reserve versus angiography for guiding percutaneous coronary intervention. *N Engl J Med* 2009;**360**:213–224.
 73. Knuuti J, Ballo H, Juarez-Orozco LE, Saraste A, Kolh P, Rutjes AWS, Juni P, Windecker S, Bax JJ, Wijns W. The performance of non-invasive tests to rule-in and rule-out significant coronary artery stenosis in patients with stable angina: a meta-analysis focused on post-test disease probability. *Eur Heart J* 2018;**39**:3322–3330.
 74. Tonino PA, Fearon WF, De Bruyne B, Oldroyd KG, Leesar MA, Ver Lee PN, Maccarthy PA, Van't Veer M, Pijls NH. Angiographic versus functional severity of coronary artery stenoses in the FAME study fractional flow reserve versus angiography in multivessel evaluation. *J Am Coll Cardiol* 2010;**55**:2816–2821.
 75. Hoffmann U, Ferencik M, Udelson JE, Picard MH, Truong QA, Patel MR, Huang M, Pencina M, Mark DB, Heitner JF, Fordyce CB, Pellikka PA, Tardif JC, Budoff M, Nahhas G, Chow B, Kosinski AS, Lee KL, Douglas PS; PROMISE Investigators. Prognostic value of noninvasive cardiovascular testing in patients with stable chest pain: insights from the PROMISE trial (Prospective Multicenter Imaging Study for Evaluation of Chest Pain). *Circulation* 2017;**135**:2320–2332.
 76. Siontis GC, Mavridis D, Greenwood JP, Coles B, Nikolakopoulou A, Juni P, Salanti G, Windecker S. Outcomes of non-invasive diagnostic modalities for the detection of coronary artery disease: network meta-analysis of diagnostic randomised controlled trials. *BMJ* 2018;**360**:k504.
 77. Collet C, Onuma Y, Andreini D, Sonck J, Pompilio G, Mushtaq S, La Meir M, Miyazaki Y, de Mey J, Gaemperli O, Ouda A, Maureira JP, Mandry D, Camenzind E, Macron L, Doenst T, Teichgraber U, Sigusch H, Asano T, Katagiri Y, Morel MA, Lindeboom W, Pontone G, Luscher TF, Bartorelli AL, Serruys PW. Coronary computed tomography angiography for heart team decision-making in multivessel coronary artery disease. *Eur Heart J* 2018;**39**:3689–3698.
 78. Lubbers M, Dedic A, Coenen A, Galema T, Akkerhuis J, Bruning T, Krenning B, Musters P, Ouhlous M, Liem A, Niezen A, Hunink M, de Feijter P, Nieman K. Calcium imaging and selective computed tomography angiography in comparison to functional testing for suspected coronary artery disease: the multicentre, randomized CRESCENT trial. *Eur Heart J* 2016;**37**:1232–1243.
 79. Zacharias K, Ahmed A, Shah BN, Gurusanthan S, Young G, Acosta D, Senior R. Relative clinical and economic impact of exercise echocardiography vs. exercise

- electrocardiography, as first line investigation in patients without known coronary artery disease and new stable angina: a randomized prospective study. *Eur Heart J Cardiovasc Imaging* 2017;**18**:195–202.
80. Williams MC, Hunter A, Shah ASV, Assi V, Lewis S, Smith J, Berry C, Boon NA, Clark E, Flather M, Forbes J, McLean S, Roditi G, van Beek EJ, Timmis AD, Newby DE; SCOT-HEART Investigators. Use of coronary computed tomographic angiography to guide management of patients with coronary disease. *J Am Coll Cardiol* 2016;**67**:1759–1768.
 81. Jorgensen ME, Andersson C, Norgaard BL, Abdulla J, Shreibati JB, Torp-Pedersen C, Gislason GH, Shaw RN, Hlatky MA. Functional testing or coronary computed tomography angiography in patients with stable coronary artery disease. *J Am Coll Cardiol* 2017;**69**:1761–1770.
 82. Roifman I, Wijeyesundera HC, Austin PC, Rezai MR, Wright GA, Tu JV. Comparison of anatomic and clinical outcomes in patients undergoing alternative initial noninvasive testing strategies for the diagnosis of stable coronary artery disease. *J Am Heart Assoc* 2017;**6**:e005462.
 83. Shaw LJ, Mieres JH, Hendel RH, Boden WE, Gulati M, Veledar E, Hachamovitch R, Arrighi JA, Merz CN, Gibbons RJ, Wenger NK, Heller GV; WOMEN Trial Investigators. Comparative effectiveness of exercise electrocardiography with or without myocardial perfusion single photon emission computed tomography in women with suspected coronary artery disease: results from the What Is the Optimal Method for Ischemia Evaluation in Women (WOMEN) trial. *Circulation* 2011;**124**:1239–1249.
 84. Steurer J, Fischer JE, Bachmann LM, Koller M, ter Riet G. Communicating accuracy of tests to general practitioners: a controlled study. *BMJ* 2002;**324**:824–826.
 85. Gueret P, Deux JF, Bonello L, Sarran A, Tron C, Christiaens L, Dacher JN, Bertrand D, Leborgne L, Renard C, Caussin C, Cluzel P, Helft G, Crochet D, Vernhet-Kovacsik H, Chabbert V, Ferrari E, Gilard M, Willoteaux S, Furber A, Barone-Rochette G, Jankowski A, Douek P, Mousseaux E, Sirol M, Niarra R, Chatellier G, Laissy JP. Diagnostic performance of computed tomography coronary angiography (from the prospective national multicenter multivendor EVASCAN study). *Am J Cardiol* 2013;**111**:471–478.
 86. Karthikeyan G, Guzik Salobir B, Jug B, Devasenapathy N, Alexanderson E, Vitola J, Kraft O, Ozkan E, Sharma S, Purohit G, Dolenc Novak M, Meave A, Trevethan S, Cerri R, Zier S, Gotthardtova L, Jonszta T, Altin T, Soydal C, Patel C, Gulati G, Paez D, Dondi M, Kashyap R. Functional compared to anatomical imaging in the initial evaluation of patients with suspected coronary artery disease: an international, multi-center, randomized controlled trial (IAEA-SPECT/CTA study). *J Nucl Cardiol* 2017;**24**:507–517.
 87. Knuuti J, Bengel F, Bax JJ, Kaufmann PA, Le Guludec D, Perrone Filardi P, Marcassa C, Ajmone Marsan N, Achenbach S, Kitsiou A, Flotats A, Eeckhout E, Minn H, Hesse B. Risks and benefits of cardiac imaging: an analysis of risks related to imaging for coronary artery disease. *Eur Heart J* 2014;**35**:633–638.
 88. Neumann FJ, Sousa-Uva M, Ahlsson A, Alfonso F, Banning AP, Benedetto U, Byrne RA, Collet JP, Falk V, Head SJ, Juni P, Kastrati A, Koller A, Kristensen SD, Niebauer J, Richter DJ, Seferovic PM, Sibbing D, Stefanini GG, Windecker S, Yadav R, Zembala MO. 2018 ESC/EACTS Guidelines on myocardial revascularization. *Eur Heart J* 2019;**40**:87–165.
 89. Escaned J, Echavarría-Pinto M, García-García HM, van de Hoef TP, de Vries T, Kaul P, Raveendran G, Altman JD, Kurz HI, Brechtken J, Tulli M, Von Birgelen C, Schneider JE, Khashaba AA, Jeremias A, Baucum J, Moreno R, Meuwissen M, Mishkel G, van Geuns RJ, Levite H, Lopez-Palop R, Mayhew M, Serruys PW, Samady H, Piek JJ, Lerman A; ADVISE II Study Group. Prospective assessment of the diagnostic accuracy of instantaneous wave-free ratio to assess coronary stenosis relevance: results of ADVISE II international, multicenter study (ADenosine Vasodilator Independent Stenosis Evaluation II). *JACC Cardiovasc Interv* 2015;**8**:824–833.
 90. Toth G, Hamilos M, Pyxaras S, Mangiacapra F, Nelis O, De Vroey F, Di Serafino L, Muller O, Van Mieghem C, Wyffels E, Heyndrickx GR, Bartunek J, Vanderheyden M, Barbato E, Wijns W, De Bruyne B. Evolving concepts of angiogram: fractional flow reserve discordances in 4000 coronary stenoses. *Eur Heart J* 2014;**35**:2831–2838.
 91. Jeremias A, Maehara A, Genereux P, Asrress KN, Berry C, De Bruyne B, Davies JE, Escaned J, Fearon WF, Gould KL, Johnson NP, Kirtane AJ, Koo BK, Marques KM, Nijjer S, Oldroyd KG, Petraco R, Piek JJ, Pijls NH, Redwood S, Siebes M, Spaan JAE, van 't Veer M, Mintz GS, Stone GW. Multicenter core laboratory comparison of the instantaneous wave-free ratio and resting Pd/Pa with fractional flow reserve: the RESOLVE study. *J Am Coll Cardiol* 2014;**63**:1253–1261.
 92. Van Belle E, Rioufol G, Pouillot C, Cuisset T, Bougrini K, Teiger E, Champagne S, Belle L, Barreau D, Hanssen M, Besnard C, Dauphin R, Dallongeville J, El Hahi Y, Sideris G, Bretelle C, Lhoest N, Barnay P, Leborgne L, Dupouy P; Investigators of the Registre Français de la FFR–R3F. Outcome impact of coronary revascularization strategy reclassification with fractional flow reserve at time of diagnostic angiography: insights from a large French multicenter fractional flow reserve registry. *Circulation* 2014;**129**:173–185.
 93. Curzen N, Rana O, Nicholas Z, Golledge P, Zaman A, Oldroyd K, Hanratty C, Banning A, Wheatcroft S, Hobson A, Chitkara K, Hildick-Smith D, McKenzie D, Calver A, Dimitrov BD, Corbett S. Does routine pressure wire assessment influence management strategy at coronary angiography for diagnosis of chest pain?: the RIPCORDER study. *Circ Cardiovasc Interv* 2014;**7**:248–255.
 94. Mason PJ, Shah B, Tamis-Holland JE, Bittl JA, Cohen MG, Safirstein J, Drachman DE, Valle JA, Rhodes D, Gilchrist IC; American Heart Association Interventional Cardiovascular Care Committee of the Council on Clinical Cardiology; Council on Cardiovascular and Stroke Nursing; Council on Peripheral Vascular Disease; Council on Genomic and Precision Medicine. An update on radial artery access and best practices for transradial coronary angiography and intervention in acute coronary syndrome: a scientific statement from the American Heart Association. *Circ Cardiovasc Interv* 2018;**11**:e000035.
 95. Arora N, Matheny ME, Sepke C, Resnic FS. A propensity analysis of the risk of vascular complications after cardiac catheterization procedures with the use of vascular closure devices. *Am Heart J* 2007;**153**:606–611.
 96. Noto TJ Jr, Johnson LW, Krone R, Weaver WF, Clark DA, Kramer JR Jr, Vetrovec GW. Cardiac catheterization 1990: a report of the Registry of the Society for Cardiac Angiography and Interventions (SCA&I). *Cathet Cardiovasc Diagn* 1991;**24**:75–83.
 97. Abidov A, Rozanski A, Hachamovitch R, Hayes SW, Aboul-Enein F, Cohen I, Friedman JD, Germano G, Berman DS. Prognostic significance of dyspnea in patients referred for cardiac stress testing. *N Engl J Med* 2005;**353**:1889–1898.
 98. Gupta S, Rohatgi A, Ayers CR, Willis BL, Haskell WL, Khera A, Drazner MH, de Lemos JA, Berry JD. Cardiorespiratory fitness and classification of risk of cardiovascular disease mortality. *Circulation* 2011;**123**:1377–1383.
 99. Gulati M, Black HR, Shaw LJ, Arnsdorf MF, Merz CN, Lauer MS, Marwick TH, Pandey DK, Wicklund RH, Thisted RA. The prognostic value of a nomogram for exercise capacity in women. *N Engl J Med* 2005;**353**:468–475.
 100. Myers J, Prakash M, Froelicher V, Do D, Partington S, Atwood JE. Exercise capacity and mortality among men referred for exercise testing. *N Engl J Med* 2002;**346**:793–801.
 101. Emond M, Mock MB, Davis KB, Fisher LD, Holmes DR Jr, Chaitman BR, Kaiser GC, Alderman E, Killip T III. Long-term survival of medically treated patients in the Coronary Artery Surgery Study (CASS) Registry. *Circulation* 1994;**90**:2645–2657.
 102. Mark DB, Shaw L, Harrell FE Jr, Hlatky MA, Lee KL, Bengtson JR, McCants CB, Califf RM, Pryor DB. Prognostic value of a treadmill exercise score in outpatients with suspected coronary artery disease. *N Engl J Med* 1991;**325**:849–853.
 103. Shaw LJ, Berman DS, Picard MH, Friedrich MG, Kwong RY, Stone GW, Senior R, Min JK, Hachamovitch R, Scherrer-Crosbie M, Mieres JH, Marwick TH, Phillips LM, Chaudhry FA, Pellikka PA, Slomka P, Arai AE, Iskandrian AE, Bateman TM, Heller GV, Miller TD, Nagel E, Goyal A, Borges-Neto S, Boden WE, Reynolds HR, Horchman JS, Maron DJ, Douglas PS; National Institutes of Health/National Heart, Lung, and Blood Institute-Sponsored ISCHEMIA Trial Investigators. Comparative definitions for moderate-severe ischemia in stress nuclear, echocardiography, and magnetic resonance imaging. *JACC Cardiovasc Imaging* 2014;**7**:593–604.
 104. Johnson NP, Toth GG, Lai D, Zhu H, Acar G, Agostoni P, Appelman Y, Arslan F, Barbato E, Chen SL, Di Serafino L, Dominguez-Franco AJ, Dupouy P, Esen AM, Esen OB, Hamilos M, Iwasaki K, Jensen LO, Jimenez-Navarro MF, Katritsis DG, Kocaman SA, Koo BK, Lopez-Palop R, Lorin JD, Miller LH, Muller O, Nam CW, Oud N, Puymirat E, Rieber J, Rioufol G, Rodes-Cabau J, Sedlis SP, Takeishi Y, Tonino PA, Van Belle E, Verna E, Werner GS, Fearon WF, Pijls NH, De Bruyne B, Gould KL. Prognostic value of fractional flow reserve: linking physiologic severity to clinical outcomes. *J Am Coll Cardiol* 2014;**64**:1641–1654.
 105. Smulders MW, Jaarsma C, Nelemans PJ, Bekkers S, Bucerius J, Leiner T, Crijns H, Wildberger JE, Schalla S. Comparison of the prognostic value of negative non-invasive cardiac investigations in patients with suspected or known coronary artery disease—a meta-analysis. *Eur Heart J Cardiovasc Imaging* 2017;**18**:980–987.
 106. Hachamovitch R, Rozanski A, Shaw LJ, Stone GW, Thomson LE, Friedman JD, Hayes SW, Cohen I, Germano G, Berman DS. Impact of ischaemia and scar on the therapeutic benefit derived from myocardial revascularization vs. medical therapy among patients undergoing stress-rest myocardial perfusion scintigraphy. *Eur Heart J* 2011;**32**:1012–1024.
 107. Barbato E, Toth GG, Johnson NP, Pijls NH, Fearon WF, Tonino PA, Curzen N, Piroth Z, Rioufol G, Juni P, De Bruyne B. A prospective natural history study of coronary atherosclerosis using fractional flow reserve. *J Am Coll Cardiol* 2016;**68**:2247–2255.
 108. Maaniitty T, Stenstrom I, Bax JJ, Uusitalo V, Ukkonen H, Kajander S, Maki M, Saraste A, Knuuti J. Prognostic value of coronary CT angiography with selective PET perfusion imaging in coronary artery disease. *JACC Cardiovasc Imaging* 2017;**10**:1361–1370.

109. Pazhenkottil AP, Nkoulou RN, Ghadri JR, Herzog BA, Buechel RR, Kuest SM, Wolfrium M, Fiechter M, Husmann L, Gaemperli O, Kaufmann PA. Prognostic value of cardiac hybrid imaging integrating single-photon emission computed tomography with coronary computed tomography angiography. *Eur Heart J* 2011;**32**:1465–1471.
110. Stanton T, Leano R, Marwick TH. Prediction of all-cause mortality from global longitudinal speckle strain: comparison with ejection fraction and wall motion scoring. *Circ Cardiovasc Imaging* 2009;**2**:356–364.
111. Haugaa KH, Grenne BL, Eek CH, Ersboll M, Valeur N, Svendsen JH, Florian A, Sjoli B, Brunvand H, Kober L, Voigt JU, Desmet W, Smiseth OA, Edvardsen T. Strain echocardiography improves risk prediction of ventricular arrhythmias after myocardial infarction. *JACC Cardiovasc Imaging* 2013;**6**:841–850.
112. Ng ACT, Prihadi EA, Antoni ML, Bertini M, Ewe SH, Ajmone Marsan N, Leung DY, Delgado V, Bax JJ. Left ventricular global longitudinal strain is predictive of all-cause mortality independent of aortic stenosis severity and ejection fraction. *Eur Heart J Cardiovasc Imaging* 2018;**19**:859–867.
113. Kalam K, Otahal P, Marwick TH. Prognostic implications of global LV dysfunction: a systematic review and meta-analysis of global longitudinal strain and ejection fraction. *Heart* 2014;**100**:1673–1680.
114. Scharrenbroich J, Hamada S, Keszei A, Schroder J, Napp A, Almalla M, Becker M, Altiok E. Use of two-dimensional speckle tracking echocardiography to predict cardiac events: comparison of patients with acute myocardial infarction and chronic coronary artery disease. *Clin Cardiol* 2018;**41**:111–118.
115. Park SJ, Ahn JM, Kang SJ, Yoon SH, Koo BK, Lee JY, Kim WJ, Park DW, Lee SW, Kim YH, Lee CW, Park SW. Intravascular ultrasound-derived minimal lumen area criteria for functionally significant left main coronary artery stenosis. *JACC Cardiovasc Interv* 2014;**7**:868–874.
116. D'Ascenzo F, Barbero U, Cerrato E, Lipinski MJ, Omede P, Montefusco A, Taha S, Naganuma T, Reith S, Voros S, Latib A, Gonzalo N, Quadri G, Colombo A, Biondi-Zoccai G, Escaned J, Moretti C, Gaita F. Accuracy of intravascular ultrasound and optical coherence tomography in identifying functionally significant coronary stenosis according to vessel diameter: a meta-analysis of 2,581 patients and 2,807 lesions. *Am Heart J* 2015;**169**:663–673.
117. Maron DJ, Boden WE, O'Rourke RA, Hartigan PM, Calfas KJ, Mancini GB, Spertus JA, Dada M, Kostuk WJ, Knudtson M, Harris CL, Sedlis SP, Zoble RG, Title LM, Gosselin G, Nawaz S, Gau GT, Blaustein AS, Bates ER, Shaw LJ, Berman DS, Chaitman BR, Weintraub WS, Teo KK; COURAGE Trial Research Group. Intensive multifactorial intervention for stable coronary artery disease: optimal medical therapy in the COURAGE (Clinical Outcomes Utilizing Revascularization and Aggressive Drug Evaluation) trial. *J Am Coll Cardiol* 2010;**55**:1348–1358.
118. Rotenstein LS, Huckman RS, Wagle NW. Making patients and doctors happier - the potential of patient-reported outcomes. *N Engl J Med* 2017;**377**:1309–1312.
119. Chow CK, Jolly S, Rao-Melacini P, Fox KA, Anand SS, Yusuf S. Association of diet, exercise, and smoking modification with risk of early cardiovascular events after acute coronary syndromes. *Circulation* 2010;**121**:750–758.
120. Booth JN III, Levitan EB, Brown TM, Farkouh ME, Safford MM, Muntner P. Effect of sustaining lifestyle modifications (nonsmoking, weight reduction, physical activity, and mediterranean diet) after healing of myocardial infarction, percutaneous intervention, or coronary bypass (from the REasons for Geographic and Racial Differences in Stroke Study). *Am J Cardiol* 2014;**113**:1933–1940.
121. Giannuzzi P, Temporelli PL, Marchioli R, Maggioni AP, Balestroni G, Ceci V, Chieffo C, Gattone M, Griffo R, Schweiger C, Tavazzi L, Urbinati S, Valagussa F, Vanuzzo D; GOSPEL Investigators. Global secondary prevention strategies to limit event recurrence after myocardial infarction: results of the GOSPEL study, a multicenter, randomized controlled trial from the Italian Cardiac Rehabilitation Network. *Arch Intern Med* 2008;**168**:2194–2204.
122. Keteyian SJ, Brawner CA, Savage PD, Ehrman JK, Schairer J, Divine G, Aldred H, Ophaug K, Ades PA. Peak aerobic capacity predicts prognosis in patients with coronary heart disease. *Am Heart J* 2008;**156**:292–300.
123. Wood DA, Kotseva K, Connolly S, Jennings C, Mead A, Jones J, Holden A, De Bacquer D, Collier T, De Backer G, Faergeman O; EUROACTION Study Group. Nurse-coordinated multidisciplinary, family-based cardiovascular disease prevention programme (EUROACTION) for patients with coronary heart disease and asymptomatic individuals at high risk of cardiovascular disease: a paired, cluster-randomised controlled trial. *Lancet* 2008;**371**:1999–2012.
124. Critchley JA, Capewell S. Mortality risk reduction associated with smoking cessation in patients with coronary heart disease: a systematic review. *JAMA* 2003;**290**:86–97.
125. Prochaska JJ, Benowitz NL. The past, present, and future of nicotine addiction therapy. *Annu Rev Med* 2016;**67**:467–486.
126. Barth J, Jacob T, Daha I, Critchley JA. Psychosocial interventions for smoking cessation in patients with coronary heart disease. *Cochrane Database Syst Rev* 2015;**7**:CD006886.
127. Mills EJ, Thorlund K, Eapen S, Wu P, Prochaska JJ. Cardiovascular events associated with smoking cessation pharmacotherapies: a network meta-analysis. *Circulation* 2014;**129**:28–41.
128. Qasim H, Karim ZA, Rivera JO, Khasawneh FT, Alshbool FZ. Impact of electronic cigarettes on the cardiovascular system. *J Am Heart Assoc* 2017;**6**:e006353.
129. El Dib R, Suzumura EA, Akl EA, Gomaa H, Agarwal A, Chang Y, Prasad M, Ashoorion V, Heels-Ansdell D, Maziak W, Guyatt G. Electronic nicotine delivery systems and/or electronic non-nicotine delivery systems for tobacco smoking cessation or reduction: a systematic review and meta-analysis. *BMJ Open* 2017;**7**:e012680.
130. Hartmann-Boyce J, McRobbie H, Bullen C, Begh R, Stead LF, Hajek P. Electronic cigarettes for smoking cessation. *Cochrane Database Syst Rev* 2016;**9**:CD010216.
131. Kalkhoran S, Glantz SA. E-cigarettes and smoking cessation in real-world and clinical settings: a systematic review and meta-analysis. *Lancet Respir Med* 2016;**4**:116–128.
132. Malas M, van der Tempel J, Schwartz R, Minichiello A, Lightfoot C, Noormohamed A, Andrews J, Zawertailo L, Ferrence R. Electronic cigarettes for smoking cessation: a systematic review. *Nicotine Tob Res* 2016;**18**:1926–1936.
133. Hajek P, Phillips-Waller A, Przulj D, Pesola F, Myers Smith K, Bisal N, Li J, Parrott S, Sasieni P, Dawkins L, Ross L, Goniewicz M, Wu Q, McRobbie HJ. A randomized trial of E-cigarettes versus nicotine-replacement therapy. *N Engl J Med* 2019;**380**:629–637.
134. Freeman AM, Morris PB, Barnard N, Esselstyn CB, Ros E, Agatston A, Devries S, O'Keefe J, Miller M, Ornish D, Williams K, Kris-Etherton P. Trending cardiovascular nutrition controversies. *J Am Coll Cardiol* 2017;**69**:1172–1187.
135. Wang X, Ouyang Y, Liu J, Zhu M, Zhao G, Bao W, Hu FB. Fruit and vegetable consumption and mortality from all causes, cardiovascular disease, and cancer: systematic review and dose-response meta-analysis of prospective cohort studies. *BMJ* 2014;**349**:g4490.
136. Sofi F, Abbate R, Gensini GF, Casini A. Accruing evidence on benefits of adherence to the Mediterranean diet on health: an updated systematic review and meta-analysis. *Am J Clin Nutr* 2010;**92**:1189–1196.
137. Miller V, Mente A, Dehghan M, Rangarajan S, Zhang X, Swaminathan S, Dagenais G, Gupta R, Mohan V, Lear S, Bangdiwala SI, Schutte AE, Wentzel-Viljoen E, Avezum A, Altuntas Y, Yusuf K, Ismail N, Peer N, Chifamba J, Diaz R, Rahman O, Mohammadifard N, Lana F, Zatonska K, Wielgosz A, Yusufali A, Iqbal R, Lopez-Jaramillo P, Khatib R, Rosengren A, Kutty VR, Li W, Liu J, Liu X, Yin L, Teo K, Anand S, Yusuf S; Prospective Urban Rural Epidemiology (PURE) study investigators. Fruit, vegetable, and legume intake, and cardiovascular disease and deaths in 18 countries (PURE): a prospective cohort study. *Lancet* 2017;**390**:2037–2049.
138. Estruch R, Ros E, Salas-Salvadó J, Covas MI, Corella D, Arós F, Gómez-Gracia E, Ruiz-Gutiérrez V, Fiol M, Lapetra J, Lamuela-Raventos RM, Serra-Majem L, Pintó X, Basora J, Muñoz MA, Sorlí JV, Martínez JA, Fitó M, Gea A, Hernán MA, Martínez-González MA; PREDIMED Study Investigators. Primary prevention of cardiovascular disease with a Mediterranean diet supplemented with extra-virgin olive oil or nuts. *N Engl J Med* 2018;**378**:e34.
139. Wood AM, Kaptoge S, Butterworth AS, Willeit P, Warnakula S, Bolton T, Paige E, Paul DS, Sweeting M, Burgess S, Bell S, Astle W, Stevens D, Koulman A, Selmer RM, Verschuren WMM, Sato S, Njolstad I, Woodward M, Salomaa V, Nordestgaard BG, Yeap BB, Fletcher A, Melander O, Kuller LH, Balkau B, Marmot M, Koenig W, Casiglia E, Cooper C, Arndt V, Franco OH, Wennberg P, Gallacher J, de la Camara AG, Volzke H, Dahm CC, Dale CE, Bergmann MM, Crespo CJ, van der Schouw YT, Kaaks R, Simons LA, Lagiou P, Schoufour JD, Boer JMA, Key TJ, Rodriguez B, Moreno-Iribas C, Davidson KW, Taylor JO, Sacerdote C, Wallace RB, Quiros JR, Tumino R, Blazer DG II, Linneberg A, Daimon M, Panico S, Howard B, Skeie G, Strandberg T, Weiderpass E, Nietert PJ, Psaty BM, Kromhout D, Salamanca-Fernandez E, Kiechl S, Krumholz HM, Grión S, Palli D, Huerta JM, Price J, Sundstrom J, Arriola L, Arima H, Travis RC, Panagiotakos DB, Karakatsani A, Trichopoulos A, Kuhn T, Grobbee DE, Barrett-Connor E, van Schoor N, Boeing H, Overvad K, Kahvanen J, Wareham N, Langenberg C, Forouhi N, Wennberg M, Despres JP, Cushman M, Cooper JA, Rodriguez CJ, Sakurai M, Shaw JE, Knuiam M, Voortman T, Meisinger C, Tjonneland A, Brenner H, Palmieri L, Dallongeville J, Brunner EJ, Assmann G, Trevisan M, Gillum RF, Ford I, Sattar N, Lazo M, Thompson SG, Ferrari P, Leon DA, Smith GD, Peto R, Jackson R, Banks E, Di Angelantonio E, Danesh J; Emerging Risk Factors Collaboration/EPIC-CVD/UK Biobank Alcohol Study Group. Risk thresholds for alcohol consumption: combined analysis of individual-participant data for 599 912 current drinkers in 83 prospective studies. *Lancet* 2018;**391**:1513–1523.
140. GBD 2016 Alcohol Collaborators. Alcohol use and burden for 195 countries and territories, 1990-2016: a systematic analysis for the Global Burden of Disease Study 2016. *Lancet* 2018;**392**:1015–1035.

141. Yusuf S, Hawken S, Ounpuu S, Dans T, Avezum A, Lanas F, McQueen M, Budaj A, Pais P, Varigos J, Lisheng L; INTERHEART Study Investigators. Effect of potentially modifiable risk factors associated with myocardial infarction in 52 countries (the INTERHEART study): case-control study. *Lancet* 2004;**364**:937–952.
142. Piano MR. Alcohol's effects on the cardiovascular system. *Alcohol Res* 2017;**38**:219–241.
143. Khan SS, Ning H, Wilkins JT, Allen N, Carnethon M, Berry JD, Sweis RN, Lloyd-Jones DM. Association of body mass index with lifetime risk of cardiovascular disease and compression of morbidity. *JAMA Cardiol* 2018;**3**:280–287.
144. Pack QR, Rodriguez-Escudero JP, Thomas RJ, Ades PA, West CP, Somers VK, Lopez-Jimenez F. The prognostic importance of weight loss in coronary artery disease: a systematic review and meta-analysis. *Mayo Clin Proc* 2014;**89**:1368–1377.
145. Gardner CD, Trepanowski JF, Del Gobbo LC, Hauser ME, Rigdon J, Ioannidis JPA, Desai M, King AC. Effect of low-fat vs low-carbohydrate diet on 12-month weight loss in overweight adults and the association with genotype pattern or insulin secretion: the DIETFITS randomized clinical trial. *JAMA* 2018;**319**:667–679.
146. Fiuzza-Luces C, Garatachea N, Berger NA, Lucia A. Exercise is the real polypill. *Physiology (Bethesda)* 2013;**28**:330–358.
147. Bruning RS, Sturek M. Benefits of exercise training on coronary blood flow in coronary artery disease patients. *Prog Cardiovasc Dis* 2015;**57**:443–453.
148. Cheng W, Zhang Z, Cheng W, Yang C, Diao L, Liu W. Associations of leisure-time physical activity with cardiovascular mortality: a systematic review and meta-analysis of 44 prospective cohort studies. *Eur J Prev Cardiol* 2018;**25**:1864–1872.
149. Lahtinen M, Toukola T, Junntila MJ, Piira OP, Lepojarvi S, Kaariainen M, Huikuri HV, Tulppo MP, Kiviniemi AM. Effect of changes in physical activity on risk for cardiac death in patients with coronary artery disease. *Am J Cardiol* 2018;**121**:143–148.
150. Stewart RAH, Held C, Hadziosmanovic N, Armstrong PW, Cannon CP, Granger CB, Hagstrom E, Hochman JS, Koenig W, Lonn E, Nicolau JC, Steg PG, Vedin O, Wallentin L, White HD; STABILITY Investigators. Physical activity and mortality in patients with stable coronary heart disease. *J Am Coll Cardiol* 2017;**70**:1689–1700.
151. Anderson L, Thompson DR, Oldridge N, Zwisler AD, Rees K, Martin N, Taylor RS. Exercise-based cardiac rehabilitation for coronary heart disease. *Cochrane Database Syst Rev* 2016;**1**:CD001800.
152. Rauch B, Davos CH, Doherty P, Saure D, Metzendorf MI, Salzwedel A, Voller H, Jensen K, Schmid JP; 'Cardiac Rehabilitation Section', European Association of Preventive Cardiology (EAPC), in cooperation with the Institute of Medical Biometry and Informatics (IMBI), Department of Medical Biometry, University of Heidelberg, Cochrane Metabolic and Endocrine Disorders Group, Institute of General Practice, Heinrich-Heine University, Düsseldorf, Germany. The prognostic effect of cardiac rehabilitation in the era of acute revascularisation and statin therapy: A systematic review and meta-analysis of randomized and non-randomized studies - The Cardiac Rehabilitation Outcome Study (CROS). *Eur J Prev Cardiol* 2016;**23**:1914–1939.
153. de Vries H, Kemps HM, van Engen-Verheul MM, Kraaijenhagen RA, Peek N. Cardiac rehabilitation and survival in a large representative community cohort of Dutch patients. *Eur Heart J* 2015;**36**:1519–1528.
154. Benzer W, Rauch B, Schmid JP, Zwisler AD, Dendale P, Davos CH, Kouidi E, Simon A, Abreu A, Pogosova N, Gaita D, Miletic B, Bonner G, Ouarrak T, McGee H; EuroCaReD study group. Exercise-based cardiac rehabilitation in twelve European countries results of the European cardiac rehabilitation registry. *Int J Cardiol* 2017;**228**:58–67.
155. Ormel J, Von Korff M, Burger H, Scott K, Demyttenaere K, Huang YQ, Posada-Villa J, Pierre Lepine J, Angermeyer MC, Levinson D, de Girolamo G, Kawakami N, Karam E, Medina-Mora ME, Gureje O, Williams D, Haro JM, Bromet EJ, Alonso J, Kessler R. Mental disorders among persons with heart disease - results from World Mental Health surveys. *Gen Hosp Psychiatry* 2007;**29**:325–334.
156. Rudisch B, Nemeroff CB. Epidemiology of comorbid coronary artery disease and depression. *Biol Psychiatry* 2003;**54**:227–240.
157. Baumeister H, Hutter N, Bengel J. Psychological and pharmacological interventions for depression in patients with coronary artery disease. *Cochrane Database Syst Rev* 2011;**9**:CD008012.
158. Richards SH, Anderson L, Jenkinson CE, Whalley B, Rees K, Davies P, Bennett P, Liu Z, West R, Thompson DR, Taylor RS. Psychological interventions for coronary heart disease: Cochrane systematic review and meta-analysis. *Eur J Prev Cardiol* 2018;**25**:247–259.
159. Rutledge T, Redwine LS, Linke SE, Mills PJ. A meta-analysis of mental health treatments and cardiac rehabilitation for improving clinical outcomes and depression among patients with coronary heart disease. *Psychosom Med* 2013;**75**:335–349.
160. Brook RD, Newby DE, Rajagopalan S. Air pollution and cardiometabolic disease: an update and call for clinical trials. *Am J Hypertens* 2017;**31**:1–10.
161. Munzel T, Schmidt FP, Steven S, Herzog J, Daiber A, Sorensen M. Environmental noise and the cardiovascular system. *J Am Coll Cardiol* 2018;**71**:688–697.
162. Steinke EE, Jaarsma T, Barnason SA, Byrne M, Doherty S, Dougherty CM, Fridlund B, Kautz DD, Martensson J, Mosack V, Moser DK; Council on Cardiovascular and Stroke Nursing of the American Heart Association and the ESC Council on Cardiovascular Nursing and Allied Professions (CCNAP). Sexual counselling for individuals with cardiovascular disease and their partners: a consensus document from the American Heart Association and the ESC Council on Cardiovascular Nursing and Allied Professions (CCNAP). *Eur Heart J* 2013;**34**:3217–3235.
163. Bispo GS, de Lima Lopes J, de Barros AL. Cardiovascular changes resulting from sexual activity and sexual dysfunction after myocardial infarction: integrative review. *J Clin Nurs* 2013;**22**:3522–3531.
164. Levine GN, Steinke EE, Bakaeen FG, Bozkurt B, Cheitlin MD, Conti JB, Foster E, Jaarsma T, Kloner RA, Lange RA, Lindau ST, Maron BJ, Moser DK, Ohman EM, Seftel AD, Stewart WJ; American Heart Association Council on Clinical Cardiology; Council on Cardiovascular Nursing; Council on Cardiovascular Surgery and Anesthesia; Council on Quality of Care and Outcomes Research. Sexual activity and cardiovascular disease: a scientific statement from the American Heart Association. *Circulation* 2012;**125**:1058–1072.
165. Stein R, Sardinha A, Araujo CG. Sexual activity and heart patients: a contemporary perspective. *Can J Cardiol* 2016;**32**:410–420.
166. Steinke EE, Mosack V, Hill TJ. Change in sexual activity after a cardiac event: the role of medications, comorbidity, and psychosocial factors. *Appl Nurs Res* 2015;**28**:244–250.
167. Chowdhury R, Khan H, Heydon E, Shroufi A, Fahimi S, Moore C, Stricker B, Mendis S, Hofman A, Mant J, Franco OH. Adherence to cardiovascular therapy: a meta-analysis of prevalence and clinical consequences. *Eur Heart J* 2013;**34**:2940–2948.
168. Gnjidic D, Bennett A, Le Couteur DG, Blyth FM, Cumming RG, Waite L, Handelsman D, Naganathan V, Matthews S, Hilmer SN. Ischemic heart disease, prescription of optimal medical therapy and geriatric syndromes in community-dwelling older men: a population-based study. *Int J Cardiol* 2015;**192**:49–55.
169. Mohammed S, Arabi A, El-Menyar A, Abdulkarim S, Aljundi A, Alqahtani A, Arafa S, Al Suwaidi J. Impact of polypharmacy on adherence to evidence-based medication in patients who underwent percutaneous coronary intervention. *Curr Vasc Pharmacol* 2016;**14**:388–393.
170. Wimmer BC, Cross AJ, Jokanovic N, Wiese MD, George J, Johnell K, Diug B, Bell JS. Clinical outcomes associated with medication regimen complexity in older people: a systematic review. *J Am Geriatr Soc* 2017;**65**:747–753.
171. Nieuwlaat R, Wilczynski N, Navarro T, Hobson N, Jeffery R, Keenanasseril A, Agoritsas T, Mistry N, Iorio A, Jack S, Sivaramalingam B, Iserman E, Mustafa RA, Jedraszewski D, Cotoi C, Haynes RB. Interventions for enhancing medication adherence. *Cochrane Database Syst Rev* 2014;**11**:CD000011.
172. Demonceau J, Ruppert T, Kristanto P, Hughes DA, Fargher E, Kardas P, De Geest S, Dobbels F, Lewek P, Urquhart J, Vrijens B; ABC project team. Identification and assessment of adherence-enhancing interventions in studies assessing medication adherence through electronically compiled drug dosing histories: a systematic literature review and meta-analysis. *Drugs* 2013;**73**:545–562.
173. Acharjee S, Teo KK, Jacobs AK, Hartigan PM, Barn K, Gosselin G, Tanguay JF, Maron DJ, Kostuk WJ, Chaitman BR, Mancini GB, Spertus JA, Dada MR, Bates ER, Booth DC, Weintraub WS, O'Rourke RA, Boden WE; COURAGE Trial Research Group. Optimal medical therapy with or without percutaneous coronary intervention in women with stable coronary disease: a pre-specified subset analysis of the Clinical Outcomes Utilizing Revascularization and Aggressive druG Evaluation (COURAGE) trial. *Am Heart J* 2016;**173**:108–117.
174. Koertge J, Weidner G, Elliott-Eller M, Scherwitz L, Merritt-Worden TA, Marlin R, Lipsenthal L, Guarneri M, Finkel R, Saunders DE Jr, McCormac P, Scheer JM, Collins RE, Ornish D. Improvement in medical risk factors and quality of life in women and men with coronary artery disease in the Multicenter Lifestyle Demonstration Project. *Am J Cardiol* 2003;**91**:1316–1322.
175. MacIntyre CR, Mahimbo A, Moa AM, Barnes M. Influenza vaccine as a coronary intervention for prevention of myocardial infarction. *Heart* 2016;**102**:1953–1956.
176. Hebsur S, Vakil E, Oetgen WJ, Kumar PN, Lazarous DF. Influenza and coronary artery disease: exploring a clinical association with myocardial infarction and analyzing the utility of vaccination in prevention of myocardial infarction. *Rev Cardiovasc Med* 2014;**15**:168–175.
177. Kadoglou NPE, Bracke F, Simmers T, Tsiodras S, Parissis J. Influenza infection and heart failure-vaccination may change heart failure prognosis? *Heart Fail Rev* 2017;**22**:329–336.
178. Clar C, Oseni Z, Flowers N, Keshtkar-Jahromi M, Rees K. Influenza vaccines for preventing cardiovascular disease. *Cochrane Database Syst Rev* 2015;**5**:CD005050.

179. Paules CI, Subbarao K. Influenza vaccination and prevention of cardiovascular disease mortality - Authors' reply. *Lancet* 2018;**391**:427–428.
180. Mohseni H, Kiran A, Khorshidi R, Rahimi K. Influenza vaccination and risk of hospitalization in patients with heart failure: a self-controlled case series study. *Eur Heart J* 2017;**38**:326–333.
181. Artinian NT, Fletcher GF, Mozaffarian D, Kris-Etherton P, Van Horn L, Lichtenstein AH, Kumanyika S, Kraus WE, Fleg JL, Redeker NS, Meiningner JC, Banks J, Stuart-Shor EM, Fletcher BJ, Miller TD, Hughes S, Braun LT, Kopin LA, Berra K, Hayman LL, Ewing LJ, Ades PA, Durstine JL, Houston-Miller N, Burke LE; American Heart Association Prevention Committee of the Council on Cardiovascular Nursing. Interventions to promote physical activity and dietary lifestyle changes for cardiovascular risk factor reduction in adults: a scientific statement from the American Heart Association. *Circulation* 2010;**122**:406–441.
182. Janssen V, De Gucht V, Dusseldorp E, Maes S. Lifestyle modification programmes for patients with coronary heart disease: a systematic review and meta-analysis of randomized controlled trials. *Eur J Prev Cardiol* 2013;**20**:620–640.
183. Aldcroft SA, Taylor NF, Blackstock FC, O'Halloran PD. Psychoeducational rehabilitation for health behavior change in coronary artery disease: a systematic review of controlled trials. *J Cardiopulm Rehabil Prev* 2011;**31**:273–281.
184. Voogdt-Pruis HR, Beusmans GH, Gorgels AP, Kester AD, Van Ree JW. Effectiveness of nurse-delivered cardiovascular risk management in primary care: a randomised trial. *Br J Gen Pract* 2010;**60**:40–46.
185. Caldeira D, Ferreira JJ, Costa J. Influenza vaccination and prevention of cardiovascular disease mortality. *Lancet* 2018;**391**:426–427.
186. Caldeira D, Costa J, Vaz-Carneiro A. [Analysis of the Cochrane Review: Influenza Vaccines for Preventing Cardiovascular Disease. Cochrane Database Syst Rev. 2015;5:CD005050]. *Acta Med Port* 2015;**28**:424–426.
187. Udell JA, Farkouh ME, Solomon SD, Vardeny O. Does influenza vaccination influence cardiovascular complications? *Expert Rev Cardiovasc Ther* 2015;**13**:593–596.
188. Camm AJ, Manolis A, Ambrosio G, Daly C, Komajda M, Lopez de Sa E, Lopez-Sendon JL, Mugelli A, Muggli F, Tamargo J. Unresolved issues in the management of chronic stable angina. *Int J Cardiol* 2015;**201**:200–207.
189. Ferrari R, Camici PG, Crea F, Danchin N, Fox K, Maggioni AP, Manolis AJ, Marzilli M, Rosano GMC, Lopez-Sendon JL. Expert consensus document: A 'diamond' approach to personalized treatment of angina. *Nat Rev Cardiol* 2018;**15**:120–132.
190. Ambrosio G, Mugelli A, Lopez-Sendon J, Tamargo J, Camm J. Management of stable angina: A commentary on the European Society of Cardiology guidelines. *Eur J Prev Cardiol* 2016;**23**:1401–1412.
191. Thadani U. Management of stable angina - current guidelines: a critical appraisal. *Cardiovasc Drugs Ther* 2016;**30**:419–426.
192. Husted SE, Ohman EM. Pharmacological and emerging therapies in the treatment of chronic angina. *Lancet* 2015;**386**:691–701.
193. National Institute for Health and Care Excellence (NICE). Stable angina: management. Clinical guideline [CG126]. <https://www.nice.org.uk/guidance/cg126> (28 March 2019).
194. Klein WW, Jackson G, Tavazzi L. Efficacy of monotherapy compared with combined antianginal drugs in the treatment of chronic stable angina pectoris: a meta-analysis. *Coron Artery Dis* 2002;**13**:427–436.
195. Rousan TA, Mathew ST, Thadani U. Drug therapy for stable angina pectoris. *Drugs* 2017;**77**:265–284.
196. Pehrsson SK, Ringqvist I, Ekdahl S, Karlsson BW, Ulvenstam G, Persson S. Monotherapy with amlodipine or atenolol versus their combination in stable angina pectoris. *Clin Cardiol* 2000;**23**:763–770.
197. Emanuelsson H, Egstrup K, Nikus K, Ellstrom J, Glud T, Pater C, Scheibel M, Tisell A, Totterman KJ, Forsby M. Antianginal efficacy of the combination of felodipine-metoprolol 10/100 mg compared with each drug alone in patients with stable effort-induced angina pectoris: a multicenter parallel group study. The TRAFFIC Study Group. *Am Heart J* 1999;**137**:854–862.
198. Belsey J, Savelieva I, Mugelli A, Camm AJ. Relative efficacy of antianginal drugs used as add-on therapy in patients with stable angina: a systematic review and meta-analysis. *Eur J Prev Cardiol* 2015;**22**:837–848.
199. Wight LJ, VandenBurg MJ, Potter CE, Freeth CJ. A large scale comparative study in general practice with nitroglycerin spray and tablet formulations in elderly patients with angina pectoris. *Eur J Clin Pharmacol* 1992;**42**:341–342.
200. Heidenreich PA, McDonald KM, Hastie T, Fadel B, Hagan V, Lee BK, Hlatky MA. Meta-analysis of trials comparing beta-blockers, calcium antagonists, and nitrates for stable angina. *JAMA* 1999;**281**:1927–1936.
201. Wei J, Wu T, Yang Q, Chen M, Ni J, Huang D. Nitrates for stable angina: a systematic review and meta-analysis of randomized clinical trials. *Int J Cardiol* 2011;**146**:4–12.
202. Ferratini M. Risk of rebound phenomenon during nitrate withdrawal. *Int J Cardiol* 1994;**45**:89–96.
203. Diaz A, Bourassa MG, Guertin MC, Tardif JC. Long-term prognostic value of resting heart rate in patients with suspected or proven coronary artery disease. *Eur Heart J* 2005;**26**:967–974.
204. Jouven X, Empana JP, Schwartz PJ, Desnos M, Courbon D, Ducimetiere P. Heart-rate profile during exercise as a predictor of sudden death. *N Engl J Med* 2005;**352**:1951–1958.
205. Shu de F, Dong BR, Lin XF, Wu TX, Liu GJ. Long-term beta blockers for stable angina: systematic review and meta-analysis. *Eur J Prev Cardiol* 2012;**19**:330–341.
206. Fox KM, Mulcahy D, Findlay I, Ford I, Dargie HJ. The Total Ischaemic Burden European Trial (TIBET). Effects of atenolol, nifedipine SR and their combination on the exercise test and the total ischaemic burden in 608 patients with stable angina. The TIBET Study Group. *Eur Heart J* 1996;**17**:96–103.
207. Wallace WA, Wellington KL, Chess MA, Liang CS. Comparison of nifedipine gastrointestinal therapeutic system and atenolol on antianginal efficacies and exercise hemodynamic responses in stable angina pectoris. *Am J Cardiol* 1994;**73**:23–28.
208. Kawanishi DT, Reid CL, Morrison EC, Rahimtoola SH. Response of angina and ischemia to long-term treatment in patients with chronic stable angina: a double-blind randomized individualized dosing trial of nifedipine, propranolol and their combination. *J Am Coll Cardiol* 1992;**19**:409–417.
209. Bangalore S, Bhatt DL, Steg PG, Weber MA, Boden WE, Hamm CW, Montalescot G, Hsu A, Fox KA, Lincoff AM. beta-blockers and cardiovascular events in patients with and without myocardial infarction: post hoc analysis from the CHARISMA trial. *Circ Cardiovasc Qual Outcomes* 2014;**7**:872–881.
210. Andersson C, Shilane D, Go AS, Chang TI, Kazi D, Solomon MD, Boothroyd DB, Hlatky MA. beta-blocker therapy and cardiac events among patients with newly diagnosed coronary heart disease. *J Am Coll Cardiol* 2014;**64**:247–252.
211. Poole-Wilson PA, Swedberg K, Cleland JG, Di Lenarda A, Hanrath P, Komajda M, Lubsen J, Lutiger B, Metra M, Remme WJ, Torp-Pedersen C, Scherhag A, Skene A; Carvedilol Or Metoprolol European Trial Investigators. Comparison of carvedilol and metoprolol on clinical outcomes in patients with chronic heart failure in the Carvedilol Or Metoprolol European Trial (COMET): randomised controlled trial. *Lancet* 2003;**362**:7–13.
212. Leizorovicz A, Lechat P, Chucherat M, Bugnard F. Bisoprolol for the treatment of chronic heart failure: a meta-analysis on individual data of two placebo-controlled studies—CIBIS and CIBIS II. Cardiac Insufficiency Bisoprolol Study. *Am Heart J* 2002;**143**:301–307.
213. Freemantle N, Cleland J, Young P, Mason J, Harrison J. beta Blockade after myocardial infarction: systematic review and meta regression analysis. *BMJ* 1999;**318**:1730–1737.
214. Packer M, Bristow MR, Cohn JN, Colucci WS, Fowler MB, Gilbert EM, Shusterman NH. The effect of carvedilol on morbidity and mortality in patients with chronic heart failure. U.S. Carvedilol Heart Failure Study Group. *N Engl J Med* 1996;**334**:1349–1355.
215. Hwang D, Lee JM, Kim HK, Choi KH, Rhee TM, Park J, Park TK, Yang JH, Song YB, Choi JH, Hahn JY, Choi SH, Koo BK, Kim YJ, Chae SC, Cho MC, Kim CJ, Gwon HC, Jeong MH, Kim HS; KAMIR Investigators. Prognostic impact of beta-blocker dose after acute myocardial infarction. *Circ J* 2019;**83**:410–417.
216. Dahl Aarvik M, Sandven I, Dondo TB, Gale CP, Ruddox V, Munkhaugen J, Atar D, Otterstad JE. Effect of oral beta-blocker treatment on mortality in contemporary post-myocardial infarction patients: a systematic review and meta-analysis. *Eur Heart J Cardiovasc Pharmacother* 2019;**5**:12–20.
217. Bangalore S, Steg G, Deedwania P, Crowley K, Eagle KA, Goto S, Ohman EM, Cannon CP, Smith SC, Zeymer U, Hoffmann EB, Messerli FH, Bhatt DL; REACH Registry Investigators. beta-Blocker use and clinical outcomes in stable outpatients with and without coronary artery disease. *JAMA* 2012;**308**:1340–1349.
218. Motivala AA, Parikh V, Roe M, Dai D, Abbott JD, Prasad A, Mukherjee D. Predictors, trends, and outcomes (among older patients ≥65 years of age) associated with beta-blocker use in patients with stable angina undergoing elective percutaneous coronary intervention: insights from the NCDR registry. *JACC Cardiovasc Interv* 2016;**9**:1639–1648.
219. Zhang H, Yuan X, Zhang H, Chen S, Zhao Y, Hua K, Rao C, Wang W, Sun H, Hu S, Zheng Z. Efficacy of long-term beta-blocker therapy for secondary prevention of long-term outcomes after coronary artery bypass grafting surgery. *Circulation* 2015;**131**:2194–2201.
220. Puymirat E, Riant E, Aissaoui N, Soria A, Ducrocq G, Coste P, Cottin Y, Aupetit JF, Bonnefoy E, Blanchard D, Cattan S, Steg G, Schiele F, Ferrières J, Juillière Y, Simon T, Danchin N. beta blockers and mortality after myocardial infarction in patients without heart failure: multicentre prospective cohort study. *BMJ* 2016;**354**:i4801.
221. Bangalore S, Makani H, Radford M, Thakur K, Toklu B, Katz SD, DiNicolantonio JJ, Devereaux PJ, Alexander KP, Wetterslev J, Messerli FH. Clinical outcomes with beta-blockers for myocardial infarction: a meta-analysis of randomized trials. *Am J Med* 2014;**127**:939–953.
222. Hong J, Barry AR. Long-term beta-blocker therapy after myocardial infarction in the reperfusion era: a systematic review. *Pharmacotherapy* 2018;**38**:546–554.
223. Tsujimoto T, Kajio H, Shapiro MF, Sugiyama T. Risk of all-cause mortality in diabetic patients taking beta-blockers. *Mayo Clin Proc* 2018;**93**:409–418.

224. Sorbets E, Steg PG, Young R, Danchin N, Greenlaw N, Ford I, Tendera M, Ferrari R, Merkely B, Parkhomenko A, Reid C, Tardif JC, Fox KM. β -blockers, calcium antagonists, and mortality in stable coronary artery disease: an international cohort study. *Eur Heart J* 2018;**40**:1399–1407.
225. Neumann A, Maura G, Weill A, Alla F, Danchin N. Clinical events after discontinuation of beta-blockers in patients without heart failure optimally treated after acute myocardial infarction: a cohort study on the French healthcare databases. *Circ Cardiovasc Qual Outcomes* 2018;**11**:e004356.
226. Pascual I, Moris C, Avanzas P. Beta-blockers and calcium channel blockers: first line agents. *Cardiovasc Drugs Ther* 2016;**30**:357–365.
227. Cooper-DeHoff RM, Chang SW, Pepine CJ. Calcium antagonists in the treatment of coronary artery disease. *Curr Opin Pharmacol* 2013;**13**:301–308.
228. Padala SK, Lavelle MP, Sidhu MS, Cabral KP, Morrone D, Boden WE, Toth PP. Antianginal therapy for stable ischemic heart disease: a contemporary review. *J Cardiovasc Pharmacol Ther* 2017;**22**:499–510.
229. Rehnqvist N, Hjemdahl P, Billing E, Bjorkander I, Eriksson SV, Forsslund L, Held C, Nasman P, Wallen NH. Effects of metoprolol vs verapamil in patients with stable angina pectoris. The Angina Prognosis Study in Stockholm (APSS). *Eur Heart J* 1996;**17**:76–81.
230. Pepine CJ, Handberg EM, Cooper-DeHoff RM, Marks RG, Kowey P, Messerli FH, Mancia G, Cangiano JL, Garcia-Barreto D, Keltai M, Erdine S, Bristol HA, Kolb HR, Bakris GL, Cohen JD, Parmley VVV; INVEST Investigators. A calcium antagonist vs a non-calcium antagonist hypertension treatment strategy for patients with coronary artery disease. The International Verapamil-Trandolapril Study (INVEST): a randomized controlled trial. *JAMA* 2003;**290**:2805–2816.
231. Ried LD, Tueth MJ, Handberg E, Kupfer S, Pepine CJ; INVEST Study Group. A Study of Antihypertensive Drugs and Depressive Symptoms (SADD-Sx) in patients treated with a calcium antagonist versus an atenolol hypertension treatment strategy in the International Verapamil SR-Trandolapril Study (INVEST). *Psychosom Med* 2005;**67**:398–406.
232. Poole-Wilson PA, Lubsen J, Kirwan BA, van Dalen FJ, Wagener G, Danchin N, Just H, Fox KA, Pocock SJ, Clayton TC, Motro M, Parker JD, Bourassa MG, Dart AM, Hildebrandt P, Hjalmarson A, Kragten JA, Molhoek GP, Otterstad JE, Seabra-Gomes R, Soler-Soler J, Weber S. Coronary disease Trial Investigating Outcome with Nifedipine gastrointestinal therapeutic system investigators. Effect of long-acting nifedipine on mortality and cardiovascular morbidity in patients with stable angina requiring treatment (ACTION trial): randomised controlled trial. *Lancet* 2004;**364**:849–857.
233. Nissen SE, Tuzcu EM, Libby P, Thompson PD, Ghali M, Garza D, Berman L, Shi H, Buebendorf E, Topol EJ; CAMELOT Investigators. Effect of antihypertensive agents on cardiovascular events in patients with coronary disease and normal blood pressure: the CAMELOT study: a randomized controlled trial. *JAMA* 2004;**292**:2217–2225.
234. Frishman WH, Glasser S, Stone P, Deedwania PC, Johnson M, Fakouhi TD. Comparison of controlled-onset, extended-release verapamil with amlodipine and amlodipine plus atenolol on exercise performance and ambulatory ischemia in patients with chronic stable angina pectoris. *Am J Cardiol* 1999;**83**:507–514.
235. Tardif JC, Ford I, Tendera M, Bourassa MG, Fox K; INITIATIVE Investigators. Efficacy of ivabradine, a new selective I(f) inhibitor, compared with atenolol in patients with chronic stable angina. *Eur Heart J* 2005;**26**:2529–2536.
236. Ruzyllo W, Tendera M, Ford I, Fox KM. Antianginal efficacy and safety of ivabradine compared with amlodipine in patients with stable effort angina pectoris: a 3-month randomised, double-blind, multicentre, noninferiority trial. *Drugs* 2007;**67**:393–405.
237. Tardif JC, Ponikowski P, Kahan T; ASSOCIATE Study Investigators. Efficacy of the I(f) current inhibitor ivabradine in patients with chronic stable angina receiving beta-blocker therapy: a 4-month, randomized, placebo-controlled trial. *Eur Heart J* 2009;**30**:540–548.
238. Fox K, Ford I, Steg PG, Tendera M, Ferrari R; BEAUTIFUL Investigators. Ivabradine for patients with stable coronary artery disease and left-ventricular systolic dysfunction (BEAUTIFUL): a randomised, double-blind, placebo-controlled trial. *Lancet* 2008;**372**:807–816.
239. Fox K, Ford I, Steg PG, Tardif JC, Tendera M, Ferrari R; SIGNIFY Investigators. Ivabradine in stable coronary artery disease without clinical heart failure. *N Engl J Med* 2014;**371**:1091–1099.
240. European Medicines Agency. European Medicines Agency recommends measures to reduce risk of heart problems with Corlentor/Procoralan (ivabradine). <https://www.ema.europa.eu/en/news/european-medicines-agency-recommends-measures-reduce-risk-heart-problems-corlentorprocoralan> (28 March 2019).
241. Doring G. Antianginal and anti-ischemic efficacy of nicorandil in comparison with isosorbide-5-mononitrate and isosorbide dinitrate: results from two multicenter, double-blind, randomized studies with stable coronary heart disease patients. *J Cardiovasc Pharmacol* 1992;**20**:574–581.
242. Di Somma S, Liguori V, Petitto M, Carotenuto A, Bokor D, de Divitiis O, de Divitiis M. A double-blind comparison of nicorandil and metoprolol in stable effort angina pectoris. *Cardiovasc Drugs Ther* 1993;**7**:119–123.
243. Zhu WL, Shan YD, Guo JX, Wei JP, Yang XC, Li TD, Jia SQ, He Q, Chen JZ, Wu ZG, Li ZQ, You K. Double-blind, multicenter, active-controlled, randomized clinical trial to assess the safety and efficacy of orally administered nicorandil in patients with stable angina pectoris in China. *Circ J* 2007;**71**:826–833.
244. Jiang J, Li Y, Zhou Y, Li X, Li H, Tang B, Dai X, Ma T, Li L, Huo Y. Oral nicorandil reduces ischemic attacks in patients with stable angina: a prospective, multicenter, open-label, randomized, controlled study. *Int J Cardiol* 2016;**224**:183–187.
245. Medicines & Healthcare products Regulatory Agency (MHRA). Public Assessment Report UKPAR. Nicorandil 10 mg Tablets. Nicorandil 20 mg Tablets. <http://www.mhra.gov.uk/home/groups/par/documents/websitesources/con786861.pdf> (28 March 2019).
246. IONA Study Group. Effect of nicorandil on coronary events in patients with stable angina: the Impact Of Nicorandil in Angina (IONA) randomised trial. *Lancet* 2002;**359**:1269–1275.
247. Morrow DA, Scirica BM, Karwatowska-Prokopczuk E, Murphy SA, Budaj A, Varshavsky S, Wolff AA, Skene A, McCabe CH, Braunwald E; MERLIN-TIMI 36 Trial Investigators. Effects of ranolazine on recurrent cardiovascular events in patients with non-ST-elevation acute coronary syndromes: the MERLIN-TIMI 36 randomized trial. *JAMA* 2007;**297**:1775–1783.
248. Wilson SR, Scirica BM, Braunwald E, Murphy SA, Karwatowska-Prokopczuk E, Buros JL, Chaitman BR, Morrow DA. Efficacy of ranolazine in patients with chronic angina observations from the randomized, double-blind, placebo-controlled MERLIN-TIMI (Metabolic Efficiency With Ranolazine for Less Ischemia in Non-ST-Segment Elevation Acute Coronary Syndromes) 36 Trial. *J Am Coll Cardiol* 2009;**53**:1510–1516.
249. Kosiborod M, Arnold SV, Spertus JA, McGuire DK, Li Y, Yue P, Ben-Yehuda O, Katz A, Jones PG, Olmsted A, Belardinelli L, Chaitman BR. Evaluation of ranolazine in patients with type 2 diabetes mellitus and chronic stable angina: results from the TERISA randomized clinical trial (Type 2 Diabetes Evaluation of Ranolazine in Subjects With Chronic Stable Angina). *J Am Coll Cardiol* 2013;**61**:2038–2045.
250. Alexander KP, Weisz G, Prather K, James S, Mark DB, Anstrom KJ, Davidson-Ray L, Witkowski A, Mulkay AJ, Osmukhina A, Farzaneh-Far R, Ben-Yehuda O, Stone GW, Ohman EM. Effects of ranolazine on angina and quality of life after percutaneous coronary intervention with incomplete revascularization: results from the Ranolazine for Incomplete Vessel Revascularization (RIVER-PCI) Trial. *Circulation* 2016;**133**:39–47.
251. Weisz G, Genereux P, Iniguez A, Zurawski A, Shechter M, Alexander KP, Dressler O, Osmukhina A, James S, Ohman EM, Ben-Yehuda O, Farzaneh-Far R, Stone GW; RIVER-PCI investigators. Ranolazine in patients with incomplete revascularisation after percutaneous coronary intervention (RIVER-PCI): a multicentre, randomised, double-blind, placebo-controlled trial. *Lancet* 2016;**387**:136–145.
252. McCarthy CP, Mullins KV, Kerins DM. The role of trimetazidine in cardiovascular disease: beyond an anti-anginal agent. *Eur Heart J Cardiovasc Pharmacother* 2016;**2**:266–272.
253. European Medicines Agency. Questions and answers on the review of medicines containing trimetazidine (20 mg tablets, 35 mg modified release tablet and 20 mg/ml oral solution). https://www.ema.europa.eu/en/documents/referral/questions-answers-review-medicines-containing-trimetazidine-20-mg-tablets-35-mg-modified-release/ml-oral-solution_en.pdf (28 March 2019).
254. European Medicines Agency. Assessment Report for trimetazidine containing medicinal products. https://www.ema.europa.eu/en/documents/referral/trimetazidine-article-31-referral-assessment-report_en.pdf (28 March 2019).
255. Peng S, Zhao M, Wan J, Fang Q, Fang D, Li K. The efficacy of trimetazidine on stable angina pectoris: a meta-analysis of randomized clinical trials. *Int J Cardiol* 2014;**177**:780–785.
256. Noman A, Ang DS, Ogston S, Lang CC, Struthers AD. Effect of high-dose allopurinol on exercise in patients with chronic stable angina: a randomised, placebo controlled crossover trial. *Lancet* 2010;**375**:2161–2167.
257. Singh JA, Yu S. Allopurinol reduces the risk of myocardial infarction (MI) in the elderly: a study of Medicare claims. *Arthritis Res Ther* 2016;**18**:209.
258. Okafor ON, Farrington K, Gorog DA. Allopurinol as a therapeutic option in cardiovascular disease. *Pharmacol Ther* 2017;**172**:139–150.
259. Kolloch R, Legler UF, Champion A, Cooper-Dehoff RM, Handberg E, Zhou Q, Pepine CJ. Impact of resting heart rate on outcomes in hypertensive patients with coronary artery disease: findings from the International Verapamil-SR/trandolapril Study (INVEST). *Eur Heart J* 2008;**29**:1327–1334.
260. Tuunanen H, Engblom E, Naum A, Nagren K, Scheinin M, Hesse B, Juhani Airaksinen KE, Nuutila P, Iozzo P, Ukkonen H, Opie LH, Knutti J. Trimetazidine, a metabolic modulator, has cardiac and extracardiac benefits in idiopathic dilated cardiomyopathy. *Circulation* 2008;**118**:1250–1258.
261. Ho JE, Bittner V, Demicco DA, Breazna A, Deedwania PC, Waters DD. Usefulness of heart rate at rest as a predictor of mortality, hospitalization for heart failure, myocardial infarction, and stroke in patients with stable coronary

- heart disease (Data from the Treating to New Targets [TNT] trial). *Am J Cardiol* 2010;**105**:905–911.
262. Al-Lamee R, Thompson D, Dehbi HM, Sen S, Tang K, Davies J, Keeble T, Mielewicz M, Kaprielian R, Malik IS, Nijjer SS, Petraco R, Cook C, Ahmad Y, Howard J, Baker C, Sharp A, Gerber R, Talwar S, Assomull R, Mayet J, Wensel R, Collier D, Shun-Shin M, Thom SA, Davies JE, Francis DP; ORBITA investigators. Percutaneous coronary intervention in stable angina (ORBITA): a double-blind, randomised controlled trial. *Lancet* 2018;**391**:31–40.
 263. Nossaman VE, Nossaman BD, Kadowitz PJ. Nitrates and nitrites in the treatment of ischemic cardiac disease. *Cardiol Rev* 2010;**18**:190–197.
 264. Davies RF, Habibi H, Klinke WP, Dessain P, Nadeau C, Phaneuf DC, Lepage S, Raman S, Herbert M, Foris K, Linden W, Buttars JA; Canadian Amlodipine/atenolol In Silent Ischemia Study (CASIS). Effect of amlodipine, atenolol and their combination on myocardial ischemia during treadmill exercise and ambulatory monitoring. Canadian Amlodipine/Atenolol in Silent Ischemia Study (CASIS) Investigators. *J Am Coll Cardiol* 1995;**25**:619–625.
 265. Salazar CA, Basilio Flores JE, Veramendi Espinoza LE, Mejia Dolores JW, Rey Rodriguez DE, Loza Munarriz C. Ranolazine for stable angina pectoris. *Cochrane Database Syst Rev* 2017;**2**:CD011747.
 266. Badran HM, Ibrahim WA, Faheem N, Yassin R, Alashkar T, Yacoub M. Provocation of left ventricular outflow tract obstruction using nitrate inhalation in hypertrophic cardiomyopathy: relation to electromechanical delay. *Glob Cardiol Sci Pract* 2015;**2015**:15.
 267. Webb DJ, Muirhead GJ, Wulff M, Sutton JA, Levi R, Dinsmore WW. Sildenafil citrate potentiates the hypotensive effects of nitric oxide donor drugs in male patients with stable angina. *J Am Coll Cardiol* 2000;**36**:25–31.
 268. CURRENT-OASIS 7 Investigators, Mehta SR, Bassand JP, Chrolavicius S, Diaz R, Eikelboom JW, Fox KA, Granger CB, Jolly S, Joyner CD, Rupprecht HJ, Widimsky P, Afzal R, Pogue J, Yusuf S. Dose comparisons of clopidogrel and aspirin in acute coronary syndromes. *N Engl J Med* 2010;**363**:930–942.
 269. Antithrombotic Trialists' Collaboration. Collaborative meta-analysis of randomised trials of antiplatelet therapy for prevention of death, myocardial infarction, and stroke in high risk patients. *BMJ* 2002;**324**:71–86.
 270. Antithrombotic Trialists' (ATT) Collaboration, Baigent C, Blackwell L, Collins R, Emberson J, Godwin J, Peto R, Buring J, Hennekens C, Kearney P, Meade T, Patrono C, Roncaglioni MC, Zanchetti A. Aspirin in the primary and secondary prevention of vascular disease: collaborative meta-analysis of individual participant data from randomised trials. *Lancet* 2009;**373**:1849–1860.
 271. Aradi D, Storey RF, Komócsi A, Trenk D, Gulba D, Kiss RG, Husted S, Bonello L, Sibbing D, Collet JP, Huber K; Working Group on Thrombosis of the European Society of Cardiology. Expert position paper on the role of platelet function testing in patients undergoing percutaneous coronary intervention. *Eur Heart J* 2014;**35**:209–215.
 272. Coxib and traditional NSAID Trialists' (CNT) Collaboration, Bhala N, Emberson J, Merhi A, Abramson S, Arber N, Baron JA, Bombardier C, Cannon C, Farkouh ME, FitzGerald GA, Goss P, Halls H, Hawk E, Hawkey C, Hennekens C, Hochberg M, Holland LE, Kearney PM, Laine L, Lanis A, Lance P, Laupacis A, Oates J, Patrono C, Schnitzer TJ, Solomon S, Tugwell P, Wilson K, Wittes J, Baigent C. Vascular and upper gastrointestinal effects of non-steroidal anti-inflammatory drugs: meta-analyses of individual participant data from randomised trials. *Lancet* 2013;**382**:769–779.
 273. CAPRIE Steering Committee. A randomised, blinded, trial of clopidogrel versus aspirin in patients at risk of ischaemic events (CAPRIE). *Lancet* 1996;**348**:1329–1339.
 274. Hiatt WR, Fowkes FG, Heizer G, Berger JS, Baumgartner I, Held P, Katona BG, Mahaffey KW, Norgren L, Jones WS, Blomster J, Millegard M, Reist C, Patel MR; EUCLID Trial Steering Committee and Investigators. Ticagrelor versus clopidogrel in symptomatic peripheral artery disease. *N Engl J Med* 2017;**376**:32–40.
 275. Agewall S, Cattaneo M, Collet JP, Andreotti F, Lip GY, Verheugt FW, Huber K, Grove EL, Morais J, Husted S, Wassmann S, Rosano G, Atar D, Pathak A, Kjeldsen K, Storey RF; ESC Working Group on Cardiovascular Pharmacology and Drug Therapy and ESC Working Group on Thrombosis. Expert position paper on the use of proton pump inhibitors in patients with cardiovascular disease and antithrombotic therapy. *Eur Heart J* 2013;**34**:1708–1713, 1713a–1713b.
 276. Wiviott SD, Braunwald E, McCabe CH, Montalescot G, Ruzyllo W, Gottlieb S, Neumann FJ, Ardissino D, De Servi S, Murphy SA, Riesmeyer J, Weerakkody G, Gibson CM, Antman EM; TRITON-TIMI 38 Investigators. Prasugrel versus clopidogrel in patients with acute coronary syndromes. *N Engl J Med* 2007;**357**:2001–2015.
 277. Roe MT, Armstrong PW, Fox KA, White HD, Prabhakaran D, Goodman SG, Cornel JH, Bhatt DL, Clemmensen P, Martinez F, Ardissino D, Nicolau JC, Boden VE, Gurbel PA, Ruzyllo W, Dalby AJ, McGuire DK, Leiva-Pons JL, Parkhomenko A, Gottlieb S, Topacio GO, Hamm C, Pavlides G, Goudev AR, Oto A, Tseng CD, Merkely B, Gasparovic V, Corbalan R, Cinteza M, McLendon RC, Winters KJ, Brown EB, Lokhnygina Y, Aylward PE, Huber K, Hochman JS, Ohman EM; TRILOGY ACS Investigators. Prasugrel versus clopidogrel for acute coronary syndromes without revascularization. *N Engl J Med* 2012;**367**:1297–1309.
 278. Gurbel PA, Bliden KP, Butler K, Tantry US, Gesheff T, Wei C, Teng R, Antonino MJ, Patil SB, Karunakaran A, Kereiakes DJ, Parris C, Purdy D, Wilson V, Ledley GS, Storey RF. Randomized double-blind assessment of the ONSET and OFFSET of the antiplatelet effects of ticagrelor versus clopidogrel in patients with stable coronary artery disease: the ONSET/OFFSET study. *Circulation* 2009;**120**:2577–2585.
 279. Storey RF, Angiolillo DJ, Patil SB, Desai B, Ecob R, Husted S, Emanuelsson H, Cannon CP, Becker RC, Wallentin L. Inhibitory effects of ticagrelor compared with clopidogrel on platelet function in patients with acute coronary syndromes: the PLATO (PLATElet inhibition and patient Outcomes) PLATELET substudy. *J Am Coll Cardiol* 2010;**56**:1456–1462.
 280. Storey RF, Bliden KP, Ecob R, Karunakaran A, Butler K, Wei C, Tantry U, Gurbel PA. Earlier recovery of platelet function after discontinuation of treatment with ticagrelor compared with clopidogrel in patients with high antiplatelet responses. *J Thromb Haemost* 2011;**9**:1730–1737.
 281. Vranckx P, Valgimigli M, Windecker S, Steg PG, Hamm C, Juni P, Garcia-Garcia HM, van Es GA, Serruys PW. Long-term ticagrelor monotherapy versus standard dual antiplatelet therapy followed by aspirin monotherapy in patients undergoing biolimus-eluting stent implantation: rationale and design of the GLOBAL LEADERS trial. *EuroIntervention* 2016;**12**:1239–1245.
 282. Wallentin L, Becker RC, Budaj A, Cannon CP, Emanuelsson H, Held C, Horrow J, Husted S, James S, Katus H, Mahaffey KW, Scirica BM, Skene A, Steg PG, Storey RF, Harrington RA; PLATO Investigators, Freij A, Thorsén M. Ticagrelor versus clopidogrel in patients with acute coronary syndromes. *N Engl J Med* 2009;**361**:1045–1057.
 283. Wallentin L, Lindholm D, Siegbahn A, Wernroth L, Becker RC, Cannon CP, Cornel JH, Himmelmann A, Giannitsis E, Harrington RA, Held C, Husted S, Katus HA, Mahaffey KW, Steg PG, Storey RF, James SK; PLATO study group. Biomarkers in relation to the effects of ticagrelor in comparison with clopidogrel in non-ST-elevation acute coronary syndrome patients managed with or without in-hospital revascularization: a substudy from the Prospective Randomized Platelet Inhibition and Patient Outcomes (PLATO) trial. *Circulation* 2014;**129**:293–303.
 284. Valgimigli M, Bueno H, Byrne RA, Collet JP, Costa F, Jeppsson A, Juni P, Kastrati A, Kolh P, Mauri L, Montalescot G, Neumann FJ, Petricevic M, Roffi M, Steg PG, Windecker S, Zamorano JL, Levine GN. 2017 ESC focused update on dual antiplatelet therapy in coronary artery disease developed in collaboration with EACTS: The Task Force for dual antiplatelet therapy in coronary artery disease of the European Society of Cardiology (ESC) and of the European Association for Cardio-Thoracic Surgery (EACTS). *Eur Heart J* 2018;**39**:213–260.
 285. Storey RF, Angiolillo DJ, Bonaca MP, Thomas MR, Judge HM, Rollini F, Franchi F, Ahsan AJ, Bhatt DL, Kuder JF, Steg PG, Cohen M, Muthusamy R, Braunwald E, Sabatine MS. Platelet inhibition with ticagrelor 60 mg versus 90 mg twice daily in the PEGASUS-TIMI 54 trial. *J Am Coll Cardiol* 2016;**67**:1145–1154.
 286. Storey RF, Bliden KP, Patil SB, Karunakaran A, Ecob R, Butler K, Teng R, Wei C, Tantry US, Gurbel PA; ONSET/OFFSET Investigators. Incidence of dyspnea and assessment of cardiac and pulmonary function in patients with stable coronary artery disease receiving ticagrelor, clopidogrel, or placebo in the ONSET/OFFSET study. *J Am Coll Cardiol* 2010;**56**:185–193.
 287. Storey RF, Becker RC, Harrington RA, Husted S, James SK, Cools F, Steg PG, Khurmi NS, Emanuelsson H, Cooper A, Cairns R, Cannon CP, Wallentin L. Characterization of dyspnoea in PLATO study patients treated with ticagrelor or clopidogrel and its association with clinical outcomes. *Eur Heart J* 2011;**32**:2945–2953.
 288. Orme RC, Parker WAE, Thomas MR, Judge HM, Baster K, Sumaya W, Morgan KP, McMellon HC, Richardson JD, Grech ED, Wheeldon NM, Hall IR, Iqbal J, Barmby D, Gunn JP, Storey RF. Study of two dose regimens of ticagrelor compared with clopidogrel in patients undergoing percutaneous coronary intervention for stable coronary artery disease (STEEL-PCI). *Circulation* 2018;**138**:1290–1300.
 289. Mauri L, Kereiakes DJ, Yeh RW, Driscoll-Shempp P, Cutlip DE, Steg PG, Normand SL, Braunwald E, Wiviott SD, Cohen DJ, Holmes DR Jr, Krucoff MW, Hermiller J, Dauerman HL, Simon DI, Kandzari DE, Garratt KN, Lee DP, Pow TK, Ver Lee P, Rinaldi MJ, Massaro JM; DAPT Study Investigators. Twelve or 30 months of dual antiplatelet therapy after drug-eluting stents. *N Engl J Med* 2014;**371**:2155–2166.
 290. Yeh RW, Kereiakes DJ, Steg PG, Windecker S, Rinaldi MJ, Gershlick AH, Cutlip DE, Cohen DJ, Tanguay JF, Jacobs A, Wiviott SD, Massaro JM, Iancu AC, Mauri L; DAPT Study Investigators. Benefits and risks of extended duration dual antiplatelet therapy after PCI in patients with and without acute myocardial infarction. *J Am Coll Cardiol* 2015;**65**:2211–2221.

291. Bhatt DL, Bonaca MP, Bansilal S, Angiolillo DJ, Cohen M, Storey RF, Im K, Murphy SA, Held P, Braunwald E, Sabatine MS, Steg PG. Reduction in ischemic events with ticagrelor in diabetic patients with prior myocardial infarction in PEGASUS-TIMI 54. *J Am Coll Cardiol* 2016;**67**:2732–2740.
292. Bansilal S, Bonaca MP, Cornel JH, Storey RF, Bhatt DL, Steg PG, Im K, Murphy SA, Angiolillo DJ, Kiss RG, Parkhomenko AN, Lopez-Sendon J, Isaza D, Goudev A, Kontny F, Held P, Jensen EC, Braunwald E, Sabatine MS, Oude Ophuis AJ. Ticagrelor for secondary prevention of atherothrombotic events in patients with multivessel coronary disease. *J Am Coll Cardiol* 2018;**71**:489–496.
293. Bonaca MP, Bhatt DL, Storey RF, Steg PG, Cohen M, Kuder J, Goodrich E, Nicolau JC, Parkhomenko A, Lopez-Sendon J, Dellborg M, Dalby A, Spinar J, Aylward P, Corbalan R, Abola MTB, Jensen EC, Held P, Braunwald E, Sabatine MS. Ticagrelor for prevention of ischemic events after myocardial infarction in patients with peripheral artery disease. *J Am Coll Cardiol* 2016;**67**:2719–2728.
294. Alexander JH, Lopes RD, James S, Kilaru R, He Y, Mohan P, Bhatt DL, Goodman S, Verheugt FW, Flather M, Huber K, Liaw D, Husted SE, Lopez-Sendon J, De Caterina R, Jansky P, Darius H, Vinereanu D, Cornel JH, Cools F, Atar D, Leiva-Pons JL, Keltai M, Ogawa H, Pais P, Parkhomenko A, Ruzyllo W, Diaz R, White H, Ruda M, Geraldes M, Lawrence J, Harrington RA, Wallentin L; APPRAISE-2 Investigators. Apixaban with antiplatelet therapy after acute coronary syndrome. *N Engl J Med* 2011;**365**:699–708.
295. Hurlen M, Abdelnoor M, Smith P, Erikssen J, Arnesen H. Warfarin, aspirin, or both after myocardial infarction. *N Engl J Med* 2002;**347**:969–974.
296. Mega JL, Braunwald E, Wiwiot SD, Bassand JP, Bhatt DL, Bode C, Burton P, Cohen M, Cook-Brun N, Fox KA, Goto S, Murphy SA, Plotnikov AN, Schneider D, Sun X, Verheugt FW, Gibson CM; ATLAS ACS 2–TIMI 51 Investigators. Rivaroxaban in patients with a recent acute coronary syndrome. *N Engl J Med* 2012;**366**:9–19.
297. Eikelboom JW, Connolly SJ, Bosch J, Dagenais GR, Hart RG, Shestakova O, Diaz R, Alings M, Lonn EM, Anand SS, Widimsky P, Hori M, Avezum A, Piegas LS, Branch KRH, Probstfeld J, Bhatt DL, Zhu J, Liang Y, Maggioni AP, Lopez-Jaramillo P, O'Donnell M, Kakkar AK, Fox KAA, Parkhomenko AN, Ertl G, Stork S, Keltai M, Ryden L, Pogosova N, Dans AL, Lanas F, Commerford PJ, Torp-Pedersen C, Guzik TJ, Verhamme PB, Vinereanu D, Kim JH, Tonkin AM, Lewis BS, Felix C, Yusuf S, Steg PG, Metsarinne KP, Cook-Brun N, Misselwitz F, Chen E, Leong D, Yusuf S; COMPASS Investigators. Rivaroxaban with or without aspirin in stable cardiovascular disease. *N Engl J Med* 2017;**377**:1319–1330.
298. Ohman EM, Roe MT, Steg PG, James SK, Povsic TJ, White J, Rockhold F, Plotnikov A, Mundt H, Strony J, Sun X, Husted S, Tendera M, Montalescot G, Bahit MC, Ardissino D, Bueno H, Claeys MJ, Nicolau JC, Cornel JH, Goto S, Kiss RG, Guray U, Park DW, Bode C, Welsh RC, Gibson CM. Clinically significant bleeding with low-dose rivaroxaban versus aspirin, in addition to P2Y12 inhibition, in acute coronary syndromes (GEMINI-ACS-1): a double-blind, multicentre, randomised trial. *Lancet* 2017;**389**:1799–1808.
299. Kirchhof P, Benussi S, Kotecha D, Ahlsson A, Atar D, Casadei B, Castella M, Diener HC, Heidbuchel H, Hendriks J, Hindricks G, Manolis AS, Oldgren J, Popescu BA, Schotten U, Van Putte B, Vardas P. 2016 ESC Guidelines for the management of atrial fibrillation developed in collaboration with EACTS. *Eur Heart J* 2016;**37**:2893–2962.
300. Lip GYH, Collet JP, Haude M, Byrne R, Chung EH, Fauchier L, Halvorsen S, Lau D, Lopez-Cabanillas N, Lettino M, Marin F, Obel I, Rubboli A, Storey RF, Valgimigli M, Huber K. 2018 Joint European consensus document on the management of antithrombotic therapy in atrial fibrillation patients presenting with acute coronary syndrome and/or undergoing percutaneous cardiovascular interventions: a joint consensus document of the European Heart Rhythm Association (EHRA), European Society of Cardiology Working Group on Thrombosis, European Association of Percutaneous Cardiovascular Interventions (EAPCI), and European Association of Acute Cardiac Care (ACCA) endorsed by the Heart Rhythm Society (HRS), Asia-Pacific Heart Rhythm Society (APHRS), Latin America Heart Rhythm Society (LAHRS), and Cardiac Arrhythmia Society of Southern Africa (CASSA). *Europace* 2019;**21**:192–193.
301. Lopes RD, Heizer G, Aronson R, Vora AN, Massaro T, Mehran R, Goodman SG, Windecker S, Darius H, Li J, Averkov O, Bahit MC, Berwanger O, Budaj A, Hijazi Z, Parkhomenko A, Sinnaeve P, Storey RF, Thiele H, Vinereanu D, Granger CB, Alexander JH; AUGUSTUS Investigators. Antithrombotic therapy after acute coronary syndrome or PCI in atrial fibrillation. *N Engl J Med* 2019;**380**:1509–1524.
302. Sousa-Uva M, Storey R, Huber K, Falk V, Leite-Moreira AF, Amour J, Al-Attar N, Ascione R, Taggart D, Collet JP; ESC Working Group on Cardiovascular Surgery and ESC Working Group on Thrombosis. Expert position paper on the management of antiplatelet therapy in patients undergoing coronary artery bypass graft surgery. *Eur Heart J* 2014;**35**:1510–1514.
303. Saw J, Wong GC, Mayo J, Bernstein V, Mancini GB, Ye J, Skarsgard P, Starovoytov A, Cairns J. Ticagrelor and aspirin for the prevention of cardiovascular events after coronary artery bypass graft surgery. *Heart* 2016;**102**:763–769.
304. Zhao Q, Zhu Y, Xu Z, Cheng Z, Mei J, Chen X, Wang X. Effect of ticagrelor plus aspirin, ticagrelor alone, or aspirin alone on saphenous vein graft patency 1 year after coronary artery bypass grafting: a randomized clinical trial. *JAMA* 2018;**319**:1677–1686.
305. Connolly SJ, Eikelboom JW, Bosch J, Dagenais G, Dyal L, Lanas F, Metsarinne K, O'Donnell M, Dans AL, Ha JW, Parkhomenko AN, Avezum AA, Lonn E, Lisheng L, Torp-Pedersen C, Widimsky P, Maggioni AP, Felix C, Keltai K, Hori M, Yusuf K, Guzik TJ, Bhatt DL, Branch KRH, Cook-Brun N, Berkowitz SD, Anand SS, Varigos JD, Fox KAA, Yusuf S; COMPASS investigators. Rivaroxaban with or without aspirin in patients with stable coronary artery disease: an international, randomised, double-blind, placebo-controlled trial. *Lancet* 2018;**391**:205–218.
306. Anand SS, Caron F, Eikelboom JW, Bosch J, Dyal L, Abovays V, Abola MT, Branch KRH, Keltai K, Bhatt DL, Verhamme P, Fox KAA, Cook-Brun N, Lanius V, Connolly SJ, Yusuf S. Major adverse limb events and mortality in patients with peripheral artery disease: the COMPASS trial. *J Am Coll Cardiol* 2018;**71**:2306–2315.
307. Bonaca MP, Bhatt DL, Cohen M, Steg PG, Storey RF, Jensen EC, Magnani G, Bansilal S, Fish MP, Im K, Bengtsson O, Oude Ophuis T, Budaj A, Theroux P, Ruda M, Hamm C, Goto S, Spinar J, Nicolau JC, Kiss RG, Murphy SA, Wiwiot SD, Held P, Braunwald E, Sabatine MS; PEGASUS-TIMI 54 Steering Committee and Investigators. Long-term use of ticagrelor in patients with prior myocardial infarction. *N Engl J Med* 2015;**372**:1791–1800.
308. Cannon CP, Bhatt DL, Oldgren J, Lip GYH, Ellis SG, Kimura T, Maeng M, Merkely B, Zeymer U, Gropper S, Nordaby M, Kleine E, Harper R, Manasse J, Januzzi JL, Ten Berg JM, Steg PG, Hohnloser SH; RE-DUAL PCI Steering Committee and Investigators. Dual antithrombotic therapy with dabigatran after PCI in atrial fibrillation. *N Engl J Med* 2017;**377**:1513–1524.
309. Dewilde WJ, Oirbans T, Verheugt FW, Kelder JC, De Smet BJ, Herrman JP, Adriaenssens T, Vrolix M, Heestermans AA, Vis MM, Tijssen JG, van 't Hof AW, ten Berg JM; WOEST study investigators. Use of clopidogrel with or without aspirin in patients taking oral anticoagulant therapy and undergoing percutaneous coronary intervention: an open-label, randomised, controlled trial. *Lancet* 2013;**381**:1107–1115.
310. Gibson CM, Mehran R, Bode C, Halperin J, Verheugt FW, Wildgoose P, Birmingham M, Ianus J, Burton P, van Eickels M, Korjian S, Daaboul Y, Lip GY, Cohen M, Husted S, Peterson ED, Fox KA. Prevention of bleeding in patients with atrial fibrillation undergoing PCI. *N Engl J Med* 2016;**375**:2423–2434.
311. Giugliano RP, Ruff CT, Braunwald E, Murphy SA, Wiwiot SD, Halperin JL, Waldo AL, Ezekowitz MD, Weitz J, Spinar J, Ruzyllo W, Ruda M, Koretsune Y, Betcher J, Shi M, Grip LT, Patel SP, Patel I, Hanyok JJ, Mercuri M, Antman EM; ENGAGE AF-TIMI 48 Investigators. Edoxaban versus warfarin in patients with atrial fibrillation. *N Engl J Med* 2013;**369**:2093–2104.
312. Steensig K, Olesen KKW, Thim T, Nielsen JC, Jensen SE, Jensen LO, Kristensen SD, Botker HE, Lip GYH, Maeng M. Should the presence or extent of coronary artery disease be quantified in the CHA2DS2-VASc score in atrial fibrillation? A report from the Western Denmark Heart Registry. *Thromb Haemost* 2018;**118**:2162–2170.
313. Garratt KN, Weaver WD, Jenkins RG, Pow TK, Mauri L, Kereiakes DJ, Winters KJ, Christen T, Alocco DJ, Lee DP. Prasugrel plus aspirin beyond 12 months is associated with improved outcomes after TAXUS Liberté paclitaxel-eluting coronary stent placement. *Circulation* 2015;**131**:62–73.
314. Bonaca MP, Bhatt DL, Steg PG, Storey RF, Cohen M, Im K, Oude Ophuis T, Budaj A, Goto S, Lopez-Sendon J, Diaz R, Dalby A, Van de Werf F, Ardissino D, Montalescot G, Aylward P, Magnani G, Jensen EC, Held P, Braunwald E, Sabatine MS. Ischaemic risk and efficacy of ticagrelor in relation to time from P2Y12 inhibitor withdrawal in patients with prior myocardial infarction: insights from PEGASUS-TIMI 54. *Eur Heart J* 2016;**37**:1133–1142.
315. Mach F, Baigent C, Catapano AL, Koskinas KC, Casula M, Badimon L, Chapman MJ, De Backer GG, Delgado V, Ference BA, Graham IM, Halliday A, Landmesser U, Mihaylova B, Pedersen TR, Riccardi G, Richter DJ, Sabatine MS, Taskinen M-R, Tokgozlu L, Wiklund O. 2019 ESC/EAS Guidelines for the management of dyslipidaemias: lipid modification to reduce cardiovascular risk. *Eur Heart J* 2020;**41**:111–188.
316. Giugliano RP, Cannon CP, Blazing MA, Nicolau JC, Corbalan R, Spinar J, Park JG, White JA, Bohula EA, Braunwald E; IMPROVE-IT (Improved Reduction of Outcomes: Vytorin Efficacy International Trial) Investigators. Benefit of adding ezetimibe to statin therapy on cardiovascular outcomes and safety in patients with versus without diabetes mellitus: results from IMPROVE-IT (Improved Reduction of Outcomes: Vytorin Efficacy International Trial). *Circulation* 2018;**137**:1571–1582.
317. Cannon CP, Blazing MA, Giugliano RP, McCagg A, White JA, Theroux P, Darius H, Lewis BS, Ophuis TO, Jukema JW, De Ferrari GM, Ruzyllo W, De Lucca P, Im K, Bohula EA, Reist C, Wiwiot SD, Tershakovec AM, Musliner TA, Braunwald E,

- Califf RM; IMPROVE-IT Investigators. Ezetimibe added to statin therapy after acute coronary syndromes. *N Engl J Med* 2015;**372**:2387–2397.
318. Lloyd-Jones DM, Morris PB, Ballantyne CM, Birtcher KK, Daly DD Jr, DePalma SM, Minissian MB, Orringer CE, Smith SC Jr. 2017 focused update of the 2016 ACC expert consensus decision pathway on the role of non-statin therapies for LDL-cholesterol lowering in the management of atherosclerotic cardiovascular disease risk: a report of the American College of Cardiology Task Force on Expert Consensus Decision Pathways. *J Am Coll Cardiol* 2017;**70**:1785–1822.
 319. Rosenson RS, Baker S, Banach M, Borow KM, Braun LT, Bruckert E, Brunham LR, Catapano AL, Elam MB, Mancini GB, Moriarty PM, Morris PB, Muntner P, Ray KK, Stroes ES, Taylor BA, Taylor VH, Watts GF, Thompson PD. Optimizing cholesterol treatment in patients with muscle complaints. *J Am Coll Cardiol* 2017;**70**:1290–1301.
 320. Sabatine MS, Giugliano RP, Keech AC, Honarpour N, Wiviott SD, Murphy SA, Kuder JF, Wang H, Liu T, Wasserman SM, Sever PS, Pedersen TR; FOURIER Steering Committee and Investigators. Evolocumab and clinical outcomes in patients with cardiovascular disease. *N Engl J Med* 2017;**376**:1713–1722.
 321. Ray KK, Ginsberg HN, Davidson MH, Pordy R, Bessac L, Minini P, Eckel RH, Cannon CP. Reductions in atherogenic lipids and major cardiovascular events: a pooled analysis of 10 ODYSSEY trials comparing alirocumab with control. *Circulation* 2016;**134**:1931–1943.
 322. Robinson JG, Farnier M, Krempf M, Bergeron J, Luc G, Averna M, Stroes ES, Langslet G, Raal FJ, El Shahawy M, Koren MJ, Lepor NE, Lorenzato C, Pordy R, Chaudhari U, Kastelein JJ; ODYSSEY LONG TERM Investigators. Efficacy and safety of alirocumab in reducing lipids and cardiovascular events. *N Engl J Med* 2015;**372**:1489–1499.
 323. Schwartz GG, Steg PG, Szarek M, Bhatt DL, Bittner VA, Diaz R, Edelberg JM, Goodman SG, Hanotin C, Harrington RA, Jukema JW, Lecroq G, Mahaffey KW, Moryusef A, Pordy R, Quintero K, Roe MT, Sasiela WJ, Tamby JF, Tricoci P, White HD, Zeiher AM; ODYSSEY OUTCOMES Committees and Investigators. Alirocumab and cardiovascular outcomes after acute coronary syndrome. *N Engl J Med* 2018;**379**:2097–2107.
 324. Schmidt AF, Pearce LS, Wilkins JT, Overington JP, Hingorani AD, Casas JP. PCSK9 monoclonal antibodies for the primary and secondary prevention of cardiovascular disease. *Cochrane Database Syst Rev* 2017;**4**:CD011748.
 325. Robinson JG, Rosenson RS, Farnier M, Chaudhari U, Sasiela WJ, Merlet L, Miller K, Kastelein JJ. Safety of very low low-density lipoprotein cholesterol levels with alirocumab: pooled data from randomized trials. *J Am Coll Cardiol* 2017;**69**:471–482.
 326. Arbel R, Hammerman A, Triki N, Greenberg D. PCSK9 inhibitors may improve cardiovascular outcomes—Can we afford them? *Int J Cardiol* 2016;**220**:242–245.
 327. Zhai C, Cong H, Liu Y, Zhang Y, Liu X, Zhang H, Ren Z. Effect of high-dose statin pretreatment on the incidence of periprocedural myocardial infarction in patients undergoing percutaneous coronary intervention: grading the evidence through a cumulative meta-analysis. *Clin Cardiol* 2015;**38**:668–678.
 328. SOLVD Investigators, Yusuf S, Pitt B, Davis CE, Hood WB, Cohn JN. Effect of enalapril on survival in patients with reduced left ventricular ejection fractions and congestive heart failure. *N Engl J Med* 1991;**325**:293–302.
 329. Pfeffer MA, Braunwald E, Moye LA, Basta L, Brown EJ Jr, Cuddy TE, Davis BR, Geltman EM, Goldman S, Flaker GC, Klein M, Lamas GA, Packer M, Rouleau J, Rouleau JL, Rutherford J, Wertheimer JH, Hawkins M; SAVE Investigators. Effect of captopril on mortality and morbidity in patients with left ventricular dysfunction after myocardial infarction. Results of the survival and ventricular enlargement trial. The SAVE Investigators. *N Engl J Med* 1992;**327**:669–677.
 330. Flather MD, Yusuf S, Kober L, Pfeffer M, Hall A, Murray G, Torp-Pedersen C, Ball S, Pogue J, Moye L, Braunwald E. Long-term ACE-inhibitor therapy in patients with heart failure or left-ventricular dysfunction: a systematic overview of data from individual patients. ACE-Inhibitor Myocardial Infarction Collaborative Group. *Lancet* 2000;**355**:1575–1581.
 331. Heart Outcomes Prevention Evaluation Study Investigators, Yusuf S, Sleight P, Pogue J, Bosch J, Davies R, Dagenais G. Effects of an angiotensin-converting-enzyme inhibitor, ramipril, on cardiovascular events in high-risk patients. *N Engl J Med* 2000;**342**:145–153.
 332. Fox KM; EUROpean trial On reduction of cardiac events with Perindopril in stable coronary Artery disease Investigators. Efficacy of perindopril in reduction of cardiovascular events among patients with stable coronary artery disease: randomised, double-blind, placebo-controlled, multicentre trial (the EUROPA study). *Lancet* 2003;**362**:782–788.
 333. Dagenais GR, Pogue J, Fox K, Simoons ML, Yusuf S. Angiotensin-converting-enzyme inhibitors in stable vascular disease without left ventricular systolic dysfunction or heart failure: a combined analysis of three trials. *Lancet* 2006;**368**:581–588.
 334. Patel A, ADVANCE Collaborative Group, MacMahon S, Chalmers J, Neal B, Woodward M, Billot L, Harrap S, Poulter N, Marre M, Cooper M, Glasziou P, Grobbee DE, Hamet P, Heller S, Liu LS, Mancia G, Mogensen CE, Pan CY, Rodgers A, Williams B. Effects of a fixed combination of perindopril and indapamide on macrovascular and microvascular outcomes in patients with type 2 diabetes mellitus (the ADVANCE trial): a randomised controlled trial. *Lancet* 2007;**370**:829–840.
 335. Braunwald E, Domanski MJ, Fowler SE, Geller NL, Gersh BJ, Hsia J, Pfeffer MA, Rice MM, Rosenberg YD, Rouleau JL; PEACE Trial Investigators. Angiotensin-converting-enzyme inhibition in stable coronary artery disease. *N Engl J Med* 2004;**351**:2058–2068.
 336. Bangalore S, Fakhri R, Wandel S, Toklu B, Wandel J, Messerli FH. Renin-angiotensin system inhibitors for patients with stable coronary artery disease without heart failure: systematic review and meta-analysis of randomized trials. *BMJ* 2017;**356**:j4.
 337. McMurray JJ, Packer M, Desai AS, Gong J, Lefkowitz MP, Rizkala AR, Rouleau JL, Shi VC, Solomon SD, Swedberg K, Zile MR; PARADIGM-HF Investigators and Committees. Angiotensin-neprilysin inhibition versus enalapril in heart failure. *N Engl J Med* 2014;**371**:993–1004.
 338. Pitt B, Zannad F, Remme WJ, Cody R, Castaigne A, Perez A, Palensky J, Wittes J. The effect of spironolactone on morbidity and mortality in patients with severe heart failure. Randomized Aldactone Evaluation Study Investigators. *N Engl J Med* 1999;**341**:709–717.
 339. Rossignol P, Girerd N, Bakris G, Vardeny O, Claggett B, McMurray JJV, Swedberg K, Krum H, van Veldhuisen DJ, Shi H, Sparyns S, Vincent J, Fay R, Lamalaz Z, Solomon SD, Zannad F, Pitt B. Impact of eplerenone on cardiovascular outcomes in heart failure patients with hypokalaemia. *Eur J Heart Fail* 2017;**19**:792–799.
 340. Ponikowski P, Voors AA, Anker SD, Bueno H, Cleland JGF, Coats AJS, Falk V, Gonzalez-Juanatey JR, Harjola VP, Jankowska EA, Jessup M, Linde C, Nihoyannopoulos P, Parissis JT, Pieske B, Riley JP, Rosano GMC, Ruilope LM, Ruschitzka F, Rutten FH, van der Meer P. 2016 ESC Guidelines for the diagnosis and treatment of acute and chronic heart failure: The Task Force for the diagnosis and treatment of acute and chronic heart failure of the European Society of Cardiology (ESC) Developed with the special contribution of the Heart Failure Association (HFA) of the ESC. *Eur Heart J* 2016;**37**:2129–2200.
 341. Baigent C, Keech A, Kearney PM, Blackwell L, Buck G, Pollicino C, Kirby A, Sourijina T, Peto R, Collins R, Simes R. Cholesterol Treatment Trialists' (CCT) Collaborators. Efficacy and safety of cholesterol-lowering treatment: prospective meta-analysis of data from 90,056 participants in 14 randomised trials of statins. *Lancet* 2005;**366**:1267–1278.
 342. Cholesterol Treatment Trialists' (CCT) Collaboration, Baigent C, Blackwell L, Emberson J, Holland LE, Reith C, Bhalra N, Peto R, Barnes EH, Keech A, Simes J, Collins R. Efficacy and safety of more intensive lowering of LDL cholesterol: a meta-analysis of data from 170,000 participants in 26 randomised trials. *Lancet* 2010;**376**:1670–1681.
 343. Kernis SJ, Harjai KJ, Stone GW, Grines LL, Boura JA, O'Neill WW, Grines CL. Does beta-blocker therapy improve clinical outcomes of acute myocardial infarction after successful primary angioplasty? *J Am Coll Cardiol* 2004;**43**:1773–1779.
 344. Manson JE, Hsia J, Johnson KC, Rossouw JE, Assaf AR, Lasser NL, Trevisan M, Black HR, Heckbert SR, Detrano R, Strickland OL, Wong ND, Crouse JR, Stein E, Cushman M; Women's Health Initiative Investigators. Estrogen plus progestin and the risk of coronary heart disease. *N Engl J Med* 2003;**349**:523–534.
 345. Spertus JA, Salisbury AC, Jones PG, Conaway DG, Thompson RC. Predictors of quality-of-life benefit after percutaneous coronary intervention. *Circulation* 2004;**110**:3789–3794.
 346. Steg PG, Greenlaw N, Tendera M, Tardif JC, Ferrari R, Al-Zaibag M, Dorian P, Hu D, Shalnova S, Sokn FJ, Ford I, Fox KM; Prospective Observational Longitudinal Registry of Patients With Stable Coronary Artery Disease (CLARIFY) Investigators. Prevalence of anginal symptoms and myocardial ischemia and their effect on clinical outcomes in outpatients with stable coronary artery disease: data from the International Observational CLARIFY Registry. *JAMA Intern Med* 2014;**174**:1651–1659.
 347. Xaplanteris P, Fournier S, Pijls NHJ, Fearon WF, Barbato E, Tonino PAL, Engstrom T, Kaab S, Dambrikk JH, Rioufol G, Toth GG, Piroth Z, Witt N, Frobert O, Kala P, Linke A, Jagic N, Mates M, Mavromatis K, Samady H, Irimpen A, Oldroyd K, Campo G, Rothenbuehler M, Juni P, De Bruyne B; FAME 2 Investigators. Five-year outcomes with PCI guided by fractional flow reserve. *N Engl J Med* 2018;**379**:250–259.
 348. Trikalinos TA, Alsheikh-Ali AA, Tatsioni A, Nallamothu BK, Kent DM. Percutaneous coronary interventions for non-acute coronary artery disease: a quantitative 20-year synopsis and a network meta-analysis. *Lancet* 2009;**373**:911–918.
 349. Stergiopoulos K, Brown DL. Initial coronary stent implantation with medical therapy vs medical therapy alone for stable coronary artery disease: meta-analysis of randomized controlled trials. *Arch Intern Med* 2012;**172**:312–319.
 350. Bangalore S, Purnani S, Kumar S, Bagos PG. Percutaneous coronary intervention versus optimal medical therapy for prevention of spontaneous myocardial infarction in subjects with stable ischemic heart disease. *Circulation* 2013;**127**:769–781.

351. Windecker S, Stortecy S, Stefanini GG, da Costa BR, Rutjes AW, Di Nisio M, Silletta MG, Maione A, Alfonso F, Clemmensen PM, Collet JP, Cremer J, Falk V, Filippatos G, Hamm C, Head S, Kappetein AP, Kastrati A, Knuuti J, Landmesser U, Laufer G, Neumann FJ, Richter D, Schauerte P, Sousa Uva M, Taggart DP, Torracca L, Valgimigli M, Wijns W, Witkowski A, Kolh P, Juni P. Revascularisation versus medical treatment in patients with stable coronary artery disease: network meta-analysis. *BMJ* 2014;**348**:g3859.
352. Zimmermann FM, Omerovic E, Fournier S, Kelbaek H, Johnson NP, Rothenbuehler M, Xaplanteris P, Abdel-Wahab M, Barbato E, Hofsten DE, Tonino PAL, Boxma-de Klerk BM, Fearon WF, Kober L, Smits PC, De Bruyne B, Pijls NHJ, Juni P, Engstrom T. Fractional flow reserve-guided percutaneous coronary intervention vs. medical therapy for patients with stable coronary lesions: meta-analysis of individual patient data. *Eur Heart J* 2019;**40**:180–186.
353. Gage RM, Burns KV, Bank AJ. Echocardiographic and clinical response to cardiac resynchronization therapy in heart failure patients with and without previous right ventricular pacing. *Eur J Heart Fail* 2014;**16**:1199–1205.
354. Moss AJ, Zareba W, Hall WJ, Klein H, Wilber DJ, Cannom DS, Daubert JP, Higgins SL, Brown MW, Andrews ML; Multicenter Automatic Defibrillator Implantation Trial II Investigators. Prophylactic implantation of a defibrillator in patients with myocardial infarction and reduced ejection fraction. *N Engl J Med* 2002;**346**:877–883.
355. Cleland JG, Daubert JC, Erdmann E, Freemantle N, Gras D, Kappenberger L, Tavazzi L; Cardiac Resynchronization-Heart Failure (CARE-HF) Study Investigators. The effect of cardiac resynchronization on morbidity and mortality in heart failure. *N Engl J Med* 2005;**352**:1539–1549.
356. Daubert C, Gold MR, Abraham WT, Ghio S, Hassager C, Goode G, Szili-Torok T, Linde C; REVERSE Study Group. Prevention of disease progression by cardiac resynchronization therapy in patients with asymptomatic or mildly symptomatic left ventricular dysfunction: insights from the European cohort of the REVERSE (Resynchronization Reverses Remodeling in Systolic Left Ventricular Dysfunction) trial. *J Am Coll Cardiol* 2009;**54**:1837–1846.
357. Velazquez EJ, Lee KL, Deja MA, Jain A, Sopko G, Marchenko A, Ali IS, Pohost G, Gradinar S, Abraham WT, Yip M, Prabhakaran D, Szwed H, Ferrazzi P, Petrie MC, O'Connor CM, Panchavinnin P, She L, Bonow RO, Rankin GR, Jones RH, Rouleau JL; STICH Investigators. Coronary-artery bypass surgery in patients with left ventricular dysfunction. *N Engl J Med* 2011;**364**:1607–1616.
358. Petrie MC, Jhund PS, She L, Adlbrecht C, Doenst T, Panza JA, Hill JA, Lee KL, Rouleau JL, Prior DL, Ali IS, Maddury J, Golba KS, White HD, Carson P, Chrzanowski L, Romanov A, Miller AB, Velazquez EJ; STICH Trial Investigators. Ten-year outcomes after coronary artery bypass grafting according to age in patients with heart failure and left ventricular systolic dysfunction: an analysis of the extended follow-up of the STICH trial (Surgical Treatment for Ischemic Heart Failure). *Circulation* 2016;**134**:1314–1324.
359. Faris RF, Flather M, Purcell H, Poole-Wilson PA, Coats AJ. Diuretics for heart failure. *Cochrane Database Syst Rev* 2012;**1**:CD003838.
360. Faris R, Flather M, Purcell H, Henein M, Poole-Wilson P, Coats A. Current evidence supporting the role of diuretics in heart failure: a meta analysis of randomized controlled trials. *Int J Cardiol* 2002;**82**:149–158.
361. Hjalmarson A, Goldstein S, Fagerberg B, Wedel H, Waagstein F, Kjekshus J, Wikstrand J, El Allaf D, Vitovec J, Aldershvile J, Halinen M, Dietz R, Neuhaus KL, Janosi A, Thorgeirsson G, Dunselman PH, Gullestad L, Kuch J, Herlitz J, Rickenbacher P, Ball S, Gottlieb S, Deedwania P. Effects of controlled-release metoprolol on total mortality, hospitalizations, and well-being in patients with heart failure: the Metoprolol CR/XL Randomized Intervention Trial in congestive heart failure (MERIT-HF). MERIT-HF Study Group. *JAMA* 2000;**283**:1295–1302.
362. Packer M, Coats AJ, Fowler MB, Katus HA, Krum H, Mohacs P, Rouleau JL, Tendera M, Castaigne A, Roecker EB, Schultz MK, DeMets DL; Carvedilol Prospective Randomized Cumulative Survival Study Group. Effect of carvedilol on survival in severe chronic heart failure. *N Engl J Med* 2001;**344**:1651–1658.
363. MERIT-HF Study Group. Effect of metoprolol CR/XL in chronic heart failure: Metoprolol CR/XL Randomised Intervention Trial in Congestive Heart Failure (MERIT-HF). *Lancet* 1999;**353**:2001–2007.
364. Packer M, Fowler MB, Roecker EB, Coats AJ, Katus HA, Krum H, Mohacs P, Rouleau JL, Tendera M, Staiger C, Holcslaw TL, Amann-Zalan I, DeMets DL; Carvedilol Prospective Randomized Cumulative Survival (COPERNICUS) Study Group. Effect of carvedilol on the morbidity of patients with severe chronic heart failure: results of the carvedilol prospective randomized cumulative survival (COPERNICUS) study. *Circulation* 2002;**106**:2194–2199.
365. CIBIS-II Investigators and Committees. The Cardiac Insufficiency Bisoprolol Study II (CIBIS-II): a randomised trial. *Lancet* 1999;**353**:9–13.
366. Flather MD, Shibata MC, Coats AJ, Van Veldhuisen DJ, Parkhomenko A, Borbola J, Cohen-Solal A, Dumitrascu D, Ferrari R, Lechat P, Soler-Soler J, Tavazzi L, Spinarova L, Toman J, Bohm M, Anker SD, Thompson SG, Poole-Wilson PA; SENIORS Investigators. Randomized trial to determine the effect of nebivolol on mortality and cardiovascular hospital admission in elderly patients with heart failure (SENIORS). *Eur Heart J* 2005;**26**:215–225.
367. Dargie HJ. Effect of carvedilol on outcome after myocardial infarction in patients with left-ventricular dysfunction: the CAPRICORN randomised trial. *Lancet* 2001;**357**:1385–1390.
368. SOLVD Investigators, Yusuf S, Pitt B, Davis CE, Hood WB Jr, Cohn JN. Effect of enalapril on mortality and the development of heart failure in asymptomatic patients with reduced left ventricular ejection fractions. *N Engl J Med* 1992;**327**:685–691.
369. Granger CB, McMurray JJ, Yusuf S, Held P, Michelson EL, Olofsson B, Ostergren J, Pfeffer MA, Swedberg K; CHARM Investigators and Committees. Effects of candesartan in patients with chronic heart failure and reduced left-ventricular systolic function intolerant to angiotensin-converting-enzyme inhibitors: the CHARM-Alternative trial. *Lancet* 2003;**362**:772–776.
370. Zannad F, McMurray JJ, Krum H, van Veldhuisen DJ, Swedberg K, Shi H, Vincent J, Pocock SJ, Pitt B; EMPHASIS-HF Study Group. Eplerenone in patients with systolic heart failure and mild symptoms. *N Engl J Med* 2011;**364**:11–21.
371. Taylor AL, Ziesche S, Yancy C, Carson P, D'Agostino R Jr, Ferdinand K, Taylor M, Adams K, Sabolinski M, Worcel M, Cohn JN; African-American Heart Failure Trial Investigators. Combination of isosorbide dinitrate and hydralazine in blacks with heart failure. *N Engl J Med* 2004;**351**:2049–2057.
372. Swedberg K, Komajda M, Bohm M, Borer JS, Ford I, Dubost-Brama A, Lerebours G, Tavazzi L; SHIFT Investigators. Ivabradine and outcomes in chronic heart failure (SHIFT): a randomised placebo-controlled study. *Lancet* 2010;**376**:875–885.
373. Fox K, Ford I, Steg PG, Tendera M, Robertson M, Ferrari R; BEAUTIFUL Investigators. Relationship between ivabradine treatment and cardiovascular outcomes in patients with stable coronary artery disease and left ventricular systolic dysfunction with limiting angina: a subgroup analysis of the randomized, controlled BEAUTIFUL trial. *Eur Heart J* 2009;**30**:2337–2345.
374. Packer M, O'Connor CM, Ghali JK, Pressler ML, Carson PE, Belkin RN, Miller AB, Neuberger GW, Frid D, Wertheimer JH, Cropp AB, DeMets DL. Effect of amlodipine on morbidity and mortality in severe chronic heart failure. Prospective Randomized Amlodipine Survival Evaluation Study Group. *N Engl J Med* 1996;**335**:1107–1114.
375. Wijesundera HC, Hansen MS, Stanton E, Cropp AS, Hall C, Dhalla NS, Ghali J, Rouleau JL; PRAISE II Investigators. Neurohormones and oxidative stress in nonischemic cardiomyopathy: relationship to survival and the effect of treatment with amlodipine. *Am Heart J* 2003;**146**:291–297.
376. Desai AS, Fang JC, Maisel WH, Baughman KL. Implantable defibrillators for the prevention of mortality in patients with nonischemic cardiomyopathy: a meta-analysis of randomized controlled trials. *JAMA* 2004;**292**:2874–2879.
377. Kadish A, Dyer A, Daubert JP, Quigg R, Estes NA, Anderson KP, Calkins H, Hoch D, Goldberger J, Shalaby A, Sanders WE, Schaechter A, Levine JH; Defibrillators in Non-Ischemic Cardiomyopathy Treatment Evaluation (DEFINITE) Investigators. Prophylactic defibrillator implantation in patients with nonischemic dilated cardiomyopathy. *N Engl J Med* 2004;**350**:2151–2158.
378. Hohnloser SH, Kuck KH, Dorian P, Roberts RS, Hampton JR, Hatala R, Fain E, Gent M, Connolly SJ; DINAMIT Investigators. Prophylactic use of an implantable cardioverter-defibrillator after acute myocardial infarction. *N Engl J Med* 2004;**351**:2481–2488.
379. Antiarrhythmics versus Implantable Defibrillators (AVID) Investigators. A comparison of antiarrhythmic-drug therapy with implantable defibrillators in patients resuscitated from near-fatal ventricular arrhythmias. *N Engl J Med* 1997;**337**:1576–1583.
380. Connolly SJ, Hallstrom AP, Cappato R, Schron EB, Kuck KH, Zipes DP, Greene HL, Boczar S, Domanski M, Follmann D, Gent M, Roberts RS. Meta-analysis of the implantable cardioverter defibrillator secondary prevention trials. AVID, CASH and CIDS studies. Antiarrhythmics vs Implantable Defibrillator study. Cardiac Arrest Study Hamburg. Canadian Implantable Defibrillator Study. *Eur Heart J* 2000;**21**:2071–2078.
381. Connolly SJ, Gent M, Roberts RS, Dorian P, Roy D, Sheldon RS, Mitchell LB, Green MS, Klein GJ, O'Brien B. Canadian implantable defibrillator study (CIDS): a randomized trial of the implantable cardioverter defibrillator against amiodarone. *Circulation* 2000;**101**:1297–1302.
382. Kuck KH, Cappato R, Siebels J, Ruppel R. Randomized comparison of antiarrhythmic drug therapy with implantable defibrillators in patients resuscitated from cardiac arrest: the Cardiac Arrest Study Hamburg (CASH). *Circulation* 2000;**102**:748–754.
383. Linde C, Abraham WT, Gold MR, St John Sutton M, Ghio S, Daubert C; REVERSE (REsynchronization reVERses Remodeling in Systolic left vEntricular dysfunction) Study Group. Randomized trial of cardiac resynchronization in mildly symptomatic heart failure patients and in asymptomatic patients with left ventricular dysfunction and previous heart failure symptoms. *J Am Coll Cardiol* 2008;**52**:1834–1843.

384. Linde C, Gold MR, Abraham WT, St John Sutton M, Ghio S, Cerkenvenik J, Daubert C; RESynchronization reVERses Remodeling in Systolic left vEntricular dysfunction Study Group. Long-term impact of cardiac resynchronization therapy in mild heart failure: 5-year results from the RESynchronization reVERses Remodeling in Systolic left vEntricular dysfunction (REVERSE) study. *Eur Heart J* 2013;**34**:2592–2599.
385. Cazeau S, Leclercq C, Lavergne T, Walker S, Varma C, Linde C, Garrigue S, Kappenberger L, Haywood GA, Santini M, Bailleul C, Daubert JC; Multisite Stimulation in Cardiomyopathies (MUSTIC) Study Investigators. Effects of multi-site biventricular pacing in patients with heart failure and intraventricular conduction delay. *N Engl J Med* 2001;**344**:873–880.
386. Cleland JG, Daubert JC, Erdmann E, Freemantle N, Gras D, Kappenberger L, Tavazzi L. Longer-term effects of cardiac resynchronization therapy on mortality in heart failure [the Cardiac Resynchronization-Heart Failure (CARE-HF) trial extension phase]. *Eur Heart J* 2006;**27**:1928–1932.
387. Cleland JG, Freemantle N, Erdmann E, Gras D, Kappenberger L, Tavazzi L, Daubert JC. Long-term mortality with cardiac resynchronization therapy in the Cardiac Resynchronization-Heart Failure (CARE-HF) trial. *Eur J Heart Fail* 2012;**14**:628–634.
388. Bristow MR, Saxon LA, Boehmer J, Krueger S, Kass DA, De Marco T, Carson P, DiCarlo L, DeMets D, White BG, DeVries DW, Feldman AM; Comparison of Medical Therapy, Pacing, and Defibrillation in Heart Failure (COMPANION) Investigators. Cardiac-resynchronization therapy with or without an implantable defibrillator in advanced chronic heart failure. *N Engl J Med* 2004;**350**:2140–2150.
389. Cleland JG, Abraham WT, Linde C, Gold MR, Young JB, Claude Daubert J, Sherfese L, Wells GA, Tang AS. An individual patient meta-analysis of five randomized trials assessing the effects of cardiac resynchronization therapy on morbidity and mortality in patients with symptomatic heart failure. *Eur Heart J* 2013;**34**:3547–3556.
390. Tang AS, Wells GA, Talajic M, Arnold MO, Sheldon R, Connolly S, Hohnloser SH, Nichol G, Birnie DH, Sapp JL, Yee R, Healey JS, Rouleau JL; Resynchronization-Defibrillation for Ambulatory Heart Failure Trial Investigators. Cardiac-resynchronization therapy for mild-to-moderate heart failure. *N Engl J Med* 2010;**363**:2385–2395.
391. Moss AJ, Hall WJ, Cannom DS, Klein H, Brown MW, Daubert JP, Estes NA III, Foster E, Greenberg H, Higgins SL, Pfeffer MA, Solomon SD, Wilber D, Zareba W; MADIT-CRT Trial Investigators. Cardiac-resynchronization therapy for the prevention of heart-failure events. *N Engl J Med* 2009;**361**:1329–1338.
392. Goldenberg I, Kutyifa V, Klein HU, Cannom DS, Brown MW, Dan A, Daubert JP, Estes NA III, Foster E, Greenberg H, Kautzner J, Klempfner R, Kuniss M, Merkely B, Pfeffer MA, Quesada A, Viskin S, McNitt S, Polonsky B, Ghanem A, Solomon SD, Wilber D, Zareba W, Moss AJ. Survival with cardiac-resynchronization therapy in mild heart failure. *N Engl J Med* 2014;**370**:1694–1701.
393. Phillips CO, Wright SM, Kern DE, Singa RM, Shepperd S, Rubin HR. Comprehensive discharge planning with postdischarge support for older patients with congestive heart failure: a meta-analysis. *JAMA* 2004;**291**:1358–1367.
394. Stewart S, Vandenberg AJ, Pearson S, Horowitz JD. Prolonged beneficial effects of a home-based intervention on unplanned readmissions and mortality among patients with congestive heart failure. *Arch Intern Med* 1999;**159**:257–261.
395. McAlister FA, Stewart S, Ferrua S, McMurray JJ. Multidisciplinary strategies for the management of heart failure patients at high risk for admission: a systematic review of randomized trials. *J Am Coll Cardiol* 2004;**44**:810–819.
396. Feltner C, Jones CD, Cene CW, Zheng ZJ, Sueta CA, Coker-Schwimmer EJ, Arvanitis M, Lohr KN, Middleton JC, Jonas DE. Transitional care interventions to prevent readmissions for persons with heart failure: a systematic review and meta-analysis. *Ann Intern Med* 2014;**160**:774–784.
397. Pursnani S, Korley F, Gopaul R, Kanade P, Chandra N, Shaw RE, Bangalore S. Percutaneous coronary intervention versus optimal medical therapy in stable coronary artery disease: a systematic review and meta-analysis of randomized clinical trials. *Circ Cardiovasc Interv* 2012;**5**:476–490.
398. Lindholm D, Lindback J, Armstrong PW, Budaj A, Cannon CP, Granger CB, Hagstrom E, Held C, Koenig W, Ostlund O, Stewart RAH, Soffer J, White HD, de Winter RJ, Steg PG, Siegbahn A, Kleber ME, Dressel A, Grammer TB, Marz W, Wallentin L. Biomarker-based risk model to predict cardiovascular mortality in patients with stable coronary disease. *J Am Coll Cardiol* 2017;**70**:813–826.
399. Hemingway H, Philipson P, Chen R, Fitzpatrick NK, Damant J, Shipley M, Abrams KR, Moreno S, McAlister KS, Palmer S, Kaski JC, Timmis AD, Hingorani AD. Evaluating the quality of research into a single prognostic biomarker: a systematic review and meta-analysis of 83 studies of C-reactive protein in stable coronary artery disease. *PLoS Med* 2010;**7**:e1000286.
400. Rapsomaniki E, Shah A, Perel P, Denaxas S, George J, Nicholas O, Udmuyan R, Feder GS, Hingorani AD, Timmis A, Smeeth L, Hemingway H. Prognostic models for stable coronary artery disease based on electronic health record cohort of 102 023 patients. *Eur Heart J* 2014;**35**:844–852.
401. Eapen DJ, Manocha P, Patel RS, Hammadah M, Veledar E, Wassel C, Nanjundappa RA, Sikora S, Malayter D, Wilson PW, Sperling L, Quyyumi AA, Epstein SE. Aggregate risk score based on markers of inflammation, cell stress, and coagulation is an independent predictor of adverse cardiovascular outcomes. *J Am Coll Cardiol* 2013;**62**:329–337.
402. Inouye M, Abraham G, Nelson CP, Wood AM, Sweeting MJ, Dudbridge F, Lai FY, Kaptoge S, Brozynska M, Wang T, Ye S, Webb TR, Rutter MK, Tzoulaki I, Patel RS, Loos RJF, Keavney B, Hemingway H, Thompson J, Watkins H, Deloukas P, Di Angelantonio E, Butterworth AS, Danesh J, Samani NJ; UK Biobank CardioMetabolic Consortium CHD Working Group. Genomic risk prediction of coronary artery disease in 480,000 adults: implications for primary prevention. *J Am Coll Cardiol* 2018;**72**:1883–1893.
403. Tada H, Melander O, Louie JZ, Catanese JJ, Rowland CM, Devlin JJ, Kathiresan S, Shiffman D. Risk prediction by genetic risk scores for coronary heart disease is independent of self-reported family history. *Eur Heart J* 2016;**37**:561–567.
404. Pereira A, Mendonca MI, Sousa AC, Borges S, Freitas S, Henriques E, Rodrigues M, Freitas AI, Guerra G, Ornelas I, Pereira D, Brehm A, Palma Dos Reis R. Genetic risk score and cardiovascular mortality in a southern European population with coronary artery disease. *Int J Clin Pract* 2017;**71**:e12956.
405. Christiansen MK, Nyegaard M, Larsen SB, Grove EL, Wurtz M, Neergaard-Petersen S, Hvas AM, Jensen HK, Kristensen SD. A genetic risk score predicts cardiovascular events in patients with stable coronary artery disease. *Int J Cardiol* 2017;**241**:411–416.
406. Vaara S, Tikkanen E, Parkkonen O, Lokki ML, Ripatti S, Perola M, Nieminen MS, Sinisalo J. Genetic risk scores predict recurrence of acute coronary syndrome. *Circ Cardiovasc Genet* 2016;**9**:172–178.
407. Mega JL, Stitzel NO, Smith JG, Chasman DI, Caulfield M, Devlin JJ, Nordio F, Hyde C, Cannon CP, Sacks F, Poulter N, Sever P, Ridker PM, Braunwald E, Melander O, Kathiresan S, Sabatine MS. Genetic risk, coronary heart disease events, and the clinical benefit of statin therapy: an analysis of primary and secondary prevention trials. *Lancet* 2015;**385**:2264–2271.
408. Harb SC, Marwick TH. Prognostic value of stress imaging after revascularization: a systematic review of stress echocardiography and stress nuclear imaging. *Am Heart J* 2014;**167**:77–85.
409. Bugiardini R, Bairey Merz CN. Angina with "normal" coronary arteries: a changing philosophy. *JAMA* 2005;**293**:477–484.
410. Vermeltfoort IA, Rajmakers PG, Odekerken DA, Kuijper AF, Zwijnenburg A, Teule GJ. Association between anxiety disorder and the extent of ischemia observed in cardiac syndrome X. *J Nucl Cardiol* 2009;**16**:405–410.
411. Asbury EA, Creed F, Collins P. Distinct psychosocial differences between women with coronary heart disease and cardiac syndrome X. *Eur Heart J* 2004;**25**:1695–1701.
412. Sara JD, Widmer RJ, Matsuzawa Y, Lennon RJ, Lerman LO, Lerman A. Prevalence of coronary microvascular dysfunction among patients with chest pain and nonobstructive coronary artery disease. *JACC Cardiovasc Interv* 2015;**8**:1445–1453.
413. Lee BK, Lim HS, Fearon WF, Yong AS, Yamada R, Tanaka S, Lee DP, Yeung AC, Tremmel JA. Invasive evaluation of patients with angina in the absence of obstructive coronary artery disease. *Circulation* 2015;**131**:1054–1060.
414. Ford TJ, Stanley B, Good R, Rocchiccioli P, McEntegart M, Watkins S, Eteiba H, Shaukat A, Lindsay M, Robertson K, Hood S, McGeoch R, McDade R, Yip E, Sidik N, McCartney P, Corcoran D, Collison D, Rush C, McConnachie A, Touyz RM, Oldroyd KG, Berry C. Stratified medical therapy using invasive coronary function testing in angina: the CorMicA trial. *J Am Coll Cardiol* 2018;**72**:2841–2855.
415. Ong P, Camici PG, Beltrame JF, Crea F, Shimokawa H, Sechtem U, Kaski JC, Bairey Merz CN; Coronary Vasomotion Disorders International Study Group (COVADIS). International standardization of diagnostic criteria for microvascular angina. *Int J Cardiol* 2018;**250**:16–20.
416. Mygind ND, Michelsen MM, Pena A, Frestad D, Dose N, Aziz A, Faber R, Host N, Gustafsson I, Hansen PR, Hansen HS, Bairey Merz CN, Kastrup J, Prescott E. Coronary microvascular function and cardiovascular risk factors in women with angina pectoris and no obstructive coronary artery disease: the iPOWER study. *J Am Heart Assoc* 2016;**5**:e003064.
417. Crea F, Camici PG, Bairey Merz CN. Coronary microvascular dysfunction: an update. *Eur Heart J* 2014;**35**:1101–1111.
418. van de Hoef TP, van Lavieren MA, Damman P, Delewi R, Piek MA, Chamuleau SA, Voskuil M, Henriques JP, Koch KT, de Winter RJ, Spaan JA, Siebes M, Tijssen JG, Meuwissen M, Piek JJ. Physiological basis and long-term clinical outcome of discordance between fractional flow reserve and coronary flow velocity reserve in coronary stenoses of intermediate severity. *Circ Cardiovasc Interv* 2014;**7**:301–311.
419. Pepine CJ, Anderson RD, Sharaf BL, Reis SE, Smith KM, Handberg EM, Johnson BD, Sopko G, Bairey Merz CN. Coronary microvascular reactivity to adenosine

- predicts adverse outcome in women evaluated for suspected ischemia results from the National Heart, Lung and Blood Institute WISE (Women's Ischemia Syndrome Evaluation) study. *J Am Coll Cardiol* 2010;**55**:2825–2832.
420. Taqueti VR, Everett BM, Murthy VL, Gaber M, Foster CR, Hainer J, Blankstein R, Dorbala S, Di Carli MF. Interaction of impaired coronary flow reserve and cardiomyocyte injury on adverse cardiovascular outcomes in patients without overt coronary artery disease. *Circulation* 2015;**131**:528–535.
421. Murthy VL, Naya M, Foster CR, Gaber M, Hainer J, Klein J, Dorbala S, Blankstein R, Di Carli MF. Association between coronary vascular dysfunction and cardiac mortality in patients with and without diabetes mellitus. *Circulation* 2012;**126**:1858–1868.
422. Lee JM, Jung JH, Hwang D, Park J, Fan Y, Na SH, Doh JH, Nam CW, Shin ES, Koo BK. Coronary flow reserve and microcirculatory resistance in patients with intermediate coronary stenosis. *J Am Coll Cardiol* 2016;**67**:1158–1169.
423. Lee JM, Choi KH, Hwang D, Park J, Jung JH, Kim HY, Jung HW, Cho YK, Yoon HJ, Song YB, Hahn JY, Doh JH, Nam CW, Shin ES, Hur SH, Koo BK. Prognostic implication of thermodilution coronary flow reserve in patients undergoing fractional flow reserve measurement. *JACC Cardiovasc Interv* 2018;**11**:1423–1433.
424. Radico F, Cicchitti V, Zimarino M, De Caterina R. Angina pectoris and myocardial ischemia in the absence of obstructive coronary artery disease: practical considerations for diagnostic tests. *JACC Cardiovasc Interv* 2014;**7**:453–463.
425. Mejia-Renteria H, van der Hoeven N, van de Hoef TP, Heemelaar J, Ryan N, Lerman A, van Royen N, Escaned J. Targeting the dominant mechanism of coronary microvascular dysfunction with intracoronary physiology tests. *Int J Cardiovasc Imaging* 2017;**33**:1041–1059.
426. Leung M, Juergens CP, Lo ST, Leung DY. Evaluation of coronary microvascular function by left ventricular contractile reserve with low-dose dobutamine echocardiography. *EuroIntervention* 2014;**9**:1202–1209.
427. Sicari R, Rigo F, Cortigiani L, Gherardi S, Galderisi M, Picano E. Additive prognostic value of coronary flow reserve in patients with chest pain syndrome and normal or near-normal coronary arteries. *Am J Cardiol* 2009;**103**:626–631.
428. Liu A, Wijesurendra RS, Liu JM, Forfar JC, Channon KM, Jerosch-Herold M, Piechnik SK, Neubauer S, Kharbada RK, Ferreira VM. Diagnosis of microvascular angina using cardiac magnetic resonance. *J Am Coll Cardiol* 2018;**71**:969–979.
429. Vermeltfoort IA, Bondarenko O, Rajmakers PG, Odekerken DA, Kuijper AF, Zwijnenburg A, van der Vis-Melsen MJ, Twisk JW, Beek AM, Teule GJ, van Rossum AC. Is subendocardial ischaemia present in patients with chest pain and normal coronary angiograms? A cardiovascular MR study. *Eur Heart J* 2007;**28**:1554–1558.
430. Shufelt CL, Thomson LE, Goykhman P, Agarwal M, Mehta PK, Sedlak T, Li N, Gill E, Samuels B, Azabal B, Kar S, Kothawade K, Minissian M, Slomka P, Berman DS, Bairey Merz CN. Cardiac magnetic resonance imaging myocardial perfusion reserve index assessment in women with microvascular coronary dysfunction and reference controls. *Cardiovasc Diagn Ther* 2013;**3**:153–160.
431. Taqueti VR, Hachamovitch R, Murthy VL, Naya M, Foster CR, Hainer J, Dorbala S, Blankstein R, Carli MF Di. Global coronary flow reserve is associated with adverse cardiovascular events independently of luminal angiographic severity and modifies the effect of early revascularization. *Circulation* 2015;**131**:19–27.
432. Echavarría-Pinto M, Escaned J, Macías E, Medina M, Gonzalo N, Petraco R, Sen S, Jimenez-Quevedo P, Hernandez R, Mila R, Ibanez B, Nunez-Gil JJ, Fernandez C, Alfonso F, Banuelos C, Garcia E, Davies J, Fernandez-Ortiz A, Macaya C. Disturbed coronary hemodynamics in vessels with intermediate stenoses evaluated with fractional flow reserve: a combined analysis of epicardial and microcirculatory involvement in ischemic heart disease. *Circulation* 2013;**128**:2557–2566.
433. Nolte F, van de Hoef TP, Meuwissen M, Voskuil M, Chamuleau SA, Henriques JP, Verberne HJ, van Eck-Smit BL, Koch KT, de Winter RJ, Spaan JA, Tijssen JG, Siebes M, Piek JJ. Increased hyperaemic coronary microvascular resistance adds to the presence of myocardial ischaemia. *EuroIntervention* 2014;**9**:1423–1431.
434. Gutierrez E, Flammer AJ, Lerman LO, Elizaga J, Lerman A, Fernandez-Aviles F. Endothelial dysfunction over the course of coronary artery disease. *Eur Heart J* 2013;**34**:3175–3181.
435. Matsuzawa Y, Sugiyama S, Sugamura K, Nozaki T, Ohba K, Konishi M, Matsubara J, Sumida H, Kaikita K, Kojima S, Nagayoshi Y, Yamamuro M, Izumiya Y, Iwashita S, Matsui K, Jinnouchi H, Kimura K, Umemura S, Ogawa H. Digital assessment of endothelial function and ischemic heart disease in women. *J Am Coll Cardiol* 2010;**55**:1688–1696.
436. Pauly DF, Johnson BD, Anderson RD, Handberg EM, Smith KM, Cooper-DeHoff RM, Sopko G, Sharaf BM, Kelsey SF, Merz CN, Pepine CJ. In women with symptoms of cardiac ischemia, nonobstructive coronary arteries, and microvascular dysfunction, angiotensin-converting enzyme inhibition is associated with improved microvascular function: a double-blind randomized study from the National Heart, Lung and Blood Institute Women's Ischemia Syndrome Evaluation (WISE). *Am Heart J* 2011;**162**:678–684.
437. Ong P, Athanasiadis A, Sechtem U. Pharmacotherapy for coronary microvascular dysfunction. *Eur Heart J Cardiovasc Pharmacother* 2015;**1**:65–71.
438. Ong P, Athanasiadis A, Borgulya G, Volksh I, Bastiaenen R, Kubik S, Hill S, Schaufele T, Mahrholdt H, Kaski JC, Sechtem U. Clinical usefulness, angiographic characteristics, and safety evaluation of intracoronary acetylcholine provocation testing among 921 consecutive white patients with unobstructed coronary arteries. *Circulation* 2014;**129**:1723–1730.
439. Schoenenberger AW, Adler E, Gujer S, Jamshidi P, Kobza R, Stuck AE, Resink TJ, Erne P. Prognostic value of an abnormal response to acetylcholine in patients with angina and non-obstructive coronary artery disease: long-term follow-up of the Heart Quest cohort. *Int J Cardiol* 2016;**221**:539–545.
440. Aziz A, Hansen HS, Sechtem U, Prescott E, Ong P. Sex-related differences in vasomotor function in patients with angina and unobstructed coronary arteries. *J Am Coll Cardiol* 2017;**70**:2349–2358.
441. Brainin P, Frestad D, Prescott E. The prognostic value of coronary endothelial and microvascular dysfunction in subjects with normal or non-obstructive coronary artery disease: a systematic review and meta-analysis. *Int J Cardiol* 2018;**254**:1–9.
442. Beltrame JF, Crea F, Kaski JC, Ogawa H, Ong P, Sechtem U, Shimokawa H, Bairey Merz CN; Coronary Vasomotion Disorders International Study Group (COVADIS). International standardization of diagnostic criteria for vasospastic angina. *Eur Heart J* 2017;**38**:2565–2568.
443. Ong P, Athanasiadis A, Perne A, Mahrholdt H, Schaufele T, Hill S, Sechtem U. Coronary vasomotor abnormalities in patients with stable angina after successful stent implantation but without in-stent restenosis. *Clin Res Cardiol* 2014;**103**:11–19.
444. Tsuburaya R, Takahashi J, Nakamura A, Nozaki E, Sugi M, Yamamoto Y, Hiramoto T, Horiguchi S, Inoue K, Goto T, Kato A, Shinozaki T, Ishida E, Miyata S, Yasuda S, Shimokawa H; NOVEL Investigators. Beneficial effects of long-acting nifedipine on coronary vasomotion abnormalities after drug-eluting stent implantation: the NOVEL study. *Eur Heart J* 2016;**37**:2713–2721.
445. JCS Joint Working Group. Guidelines for diagnosis and treatment of patients with vasospastic angina (Coronary Spastic Angina) (JCS 2013). *Circ J* 2014;**78**:2779–2801.
446. Takagi Y, Yasuda S, Takahashi J, Tsunoda R, Ogata Y, Seki A, Sumiyoshi T, Matsui M, Goto T, Tanabe Y, Sueda S, Sato T, Ogawa S, Kubo N, Momomura S, Ogawa H, Shimokawa H; Japanese Coronary Spasm Association. Clinical implications of provocation tests for coronary artery spasm: safety, arrhythmic complications, and prognostic impact: multicentre registry study of the Japanese Coronary Spasm Association. *Eur Heart J* 2013;**34**:258–267.
447. Buxton A, Goldberg S, Hirshfeld JW, Wilson J, Mann T, Williams DO, Overlie P, Oliva P. Refractory ergonovine-induced coronary vasospasm: importance of intracoronary nitroglycerin. *Am J Cardiol* 1980;**46**:329–334.
448. Laaksone R, Ekroos K, Sysi-Aho M, Hilvo M, Vihervaara T, Kauhanen D, Suoniemi M, Hurme R, Marz W, Schrnagl H, Stojakovic T, Vlachopoulou E, Lokki ML, Nieminen MS, Klingenberg R, Matter CM, Hornemann T, Juni P, Rodondi N, Raber L, Windecker S, Gencer B, Pedersen ER, Tell GS, Nygard O, Mach F, Sinisalo J, Luscher TF. Plasma ceramides predict cardiovascular death in patients with stable coronary artery disease and acute coronary syndromes beyond LDL-cholesterol. *Eur Heart J* 2016;**37**:1967–1976.
449. Yeboah J, McClelland RL, Polonsky TS, Burke GL, Sibley CT, O'Leary D, Carr JJ, Goff DC, Greenland P, Herrington DM. Comparison of novel risk markers for improvement in cardiovascular risk assessment in intermediate-risk individuals. *JAMA* 2012;**308**:788–795.
450. Zellweger MJ, Hachamovitch R, Kang X, Hayes SW, Friedman JD, Germano G, Berman DS. Threshold, incidence, and predictors of prognostically high-risk silent ischemia in asymptomatic patients without prior diagnosis of coronary artery disease. *J Nucl Cardiol* 2009;**16**:193–200.
451. Dahlén T, Edgren G, Lambe M, Höglund M, Björkholm M, Sandin F, Sjölander A, Richter J, Olsson-Strömberg U, Ohm L, Bäck M, Stenke L; Swedish CML Group and the Swedish CML Register Group. Cardiovascular events associated with use of tyrosine kinase inhibitors in chronic myeloid leukemia: a population-based cohort study. *Ann Intern Med* 2016;**165**:161–166.
452. Darby S, McGale P, Peto R, Granath F, Hall P, Ekbom A. Mortality from cardiovascular disease more than 10 years after radiotherapy for breast cancer: nationwide cohort study of 90 000 Swedish women. *BMJ* 2003;**326**:256–257.
453. Hoening MJ, Botma A, Aleman BM, Baaijens MH, Bartelink H, Klijn JG, Taylor CW, van Leeuwen FE. Long-term risk of cardiovascular disease in 10-year survivors of breast cancer. *J Natl Cancer Inst* 2007;**99**:365–375.
454. Peters MJ, Symmons DP, McCarey D, Dijkmans BA, Nicola P, Kvien TK, McInnes IB, Haentzschel H, Gonzalez-Gay MA, Provan S, Semb A, Sidiroopoulos P, Kitag G, Smulders YM, Soubrier M, Szekanez Z, Sattar N, Nurmohamed MT. EULAR evidence-based recommendations for cardiovascular risk management in patients with rheumatoid arthritis and other forms of inflammatory arthritis. *Ann Rheum Dis* 2010;**69**:325–331.

455. Scientific Steering Committee on behalf of the Simon Broome Register Group. Risk of fatal coronary heart disease in familial hypercholesterolaemia. *BMJ* 1991;**303**:893–896.
456. Nordestgaard BG, Chapman MJ, Humphries SE, Ginsberg HN, Masana L, Descamps OS, Wiklund O, Hegele RA, Raal FJ, Defesche JC, Wiegman A, Santos RD, Watts GF, Parhofer KG, Hovingh GK, Kovanen PT, Boileau C, Aversa M, Boren J, Bruckert E, Catapano AL, Kuivenhoven JA, Pajukanta P, Ray K, Stalenhoef AF, Stroes E, Taskinen MR, Tybjaerg-Hansen A; European Atherosclerosis Society Consensus Panel. Familial hypercholesterolaemia is underdiagnosed and undertreated in the general population: guidance for clinicians to prevent coronary heart disease: consensus statement of the European Atherosclerosis Society. *Eur Heart J* 2013;**34**:3478–3490a.
457. Zeb I, Budoff M. Coronary artery calcium screening: does it perform better than other cardiovascular risk stratification tools? *Int J Mol Sci* 2015;**16**:6606–6620.
458. Gupta A, Kesavabhotla K, Baradaran H, Kamel H, Pandya A, Giambone AE, Wright D, Pain KJ, Mtui EE, Suri JS, Sanelli PC, Mushlin AI. Plaque echolucency and stroke risk in asymptomatic carotid stenosis: a systematic review and meta-analysis. *Stroke* 2015;**46**:91–97.
459. Ankle Brachial Index Collaboration, Fowkes FG, Murray GD, Butcher I, Heald CL, Lee RJ, Chambless LE, Folsom AR, Hirsch AT, Dramaix M, deBacker G, Wautrecht JC, Kornitzer M, Newman AB, Cushman M, Sutton-Tyrrell K, Fowkes FG, Lee AJ, Price JF, d'Agostino RB, Murabito JM, Norman PE, Jamrozik K, Curb JD, Masaki KH, Rodriguez BL, Dekker JM, Bouter LM, Heine RJ, Nijpels G, Stehouwer CD, Ferrucci L, McDermott MM, Stoffers HE, Hooi JD, Knottnerus JA, Ogren M, Hedblad B, Witteman JC, Breteler MM, Hunin MG, Hofman A, Criqui MH, Langer RD, Fronck A, Hiatt WR, Hamman R, Resnick HE, Guralnik J, McDermott MM. Ankle brachial index combined with Framingham Risk Score to predict cardiovascular events and mortality: a meta-analysis. *JAMA* 2008;**300**:197–208.
460. Den Ruijter HM, Peters SA, Anderson TJ, Britton AR, Dekker JM, Eijkemans MJ, Engstrom G, Evans GW, de Graaf J, Grobbee DE, Hedblad B, Hofman A, Holewijn S, Ikeda A, Kavousi M, Kitagawa K, Kitamura A, Koffijberg H, Lonn EM, Lorenz MW, Mathiesen EB, Nijpels G, Okazaki S, O'Leary DH, Polak JF, Price JF, Robertson C, Rembold CM, Rosvall M, Rundek T, Salonen JT, Sitzer M, Stehouwer CD, Witteman JC, Moons KG, Bots ML. Common carotid intima-media thickness measurements in cardiovascular risk prediction: a meta-analysis. *JAMA* 2012;**308**:796–803.
461. Ioannidis JP, Tzoulaki I. Minimal and null predictive effects for the most popular blood biomarkers of cardiovascular disease. *Circ Res* 2012;**110**:658–662.
462. Wurtz P, Havulinna AS, Soininen P, Tynkynen T, Prieto-Merino D, Tillin T, Ghorbani A, Artati A, Wang Q, Tiainen M, Kangas AJ, Kettunen J, Kaikkonen J, Mikkila V, Jula A, Kahonen M, Lehtimäki T, Lawlor DA, Gaunt TR, Hughes AD, Sattar N, Illig T, Adamski J, Wang TJ, Perola M, Ripatti S, Vasani RS, Raitakari OT, Gerszten RE, Casas JP, Chaturvedi N, Ala-Korpela M, Salonen V. Metabolite profiling and cardiovascular event risk: a prospective study of 3 population-based cohorts. *Circulation* 2015;**131**:774–785.
463. Ettehad D, Emdin CA, Kiran A, Anderson SG, Callender T, Emberson J, Chalmers J, Rodgers A, Rahimi K. Blood pressure lowering for prevention of cardiovascular disease and death: a systematic review and meta-analysis. *Lancet* 2016;**387**:957–967.
464. Williams B, Mancia G, Spiering W, Agabiti Rosei E, Azizi M, Burnier M, Clement DL, Coca A, de Simone G, Dominiczak A, Kahan T, Mahfoud F, Redon J, Rulope L, Zanchetti A, Kerins M, Kjeldsen SE, Kreutz R, Laurent S, Lip GYH, McManus R, Narkiewicz K, Ruschitzka F, Schmieder RE, Shlyakhto E, Tsioufis C, Aboyans V, Desormais I. 2018 ESC/ESH Guidelines for the management of arterial hypertension. *Eur Heart J* 2018;**39**:3021–3104.
465. Vidal-Petiot E, Ford I, Greenlaw N, Ferrari R, Fox KM, Tardif JC, Tendera M, Tavazzi L, Bhatt DL, Steg PG; CLARIFY Investigators. Cardiovascular event rates and mortality according to achieved systolic and diastolic blood pressure in patients with stable coronary artery disease: an international cohort study. *Lancet* 2016;**388**:2142–2152.
466. Bohm M, Schumacher H, Teo KK, Lonn EM, Mahfoud F, Mann JFE, Mancia G, Redon J, Schmieder RE, Sliwa K, Weber MA, Williams B, Yusuf S. Achieved blood pressure and cardiovascular outcomes in high-risk patients: results from ONTARGET and TRANSCEND trials. *Lancet* 2017;**389**:2226–2237.
467. Law MR, Morris JK, Wald NJ. Use of blood pressure lowering drugs in the prevention of cardiovascular disease: meta-analysis of 147 randomised trials in the context of expectations from prospective epidemiological studies. *BMJ* 2009;**338**:b1665.
468. Fried LF, Emanuele N, Zhang JH, Brophy M, Conner TA, Duckworth W, Leehey DJ, McCullough PA, O'Connor T, Palevsky PM, Reilly RF, Seliger SL, Warren SR, Watnick S, Peduzzi P, Guarino P, VA NEPHRON-D Investigators. Combined angiotensin inhibition for the treatment of diabetic nephropathy. *N Engl J Med* 2013;**369**:1892–1903.
469. ONTARGET Investigators, Yusuf S, Teo KK, Pogue J, Dyal L, Copland I, Schumacher H, Dagenais G, Sleight P, Anderson C. Telmisartan, ramipril, or both in patients at high risk for vascular events. *N Engl J Med* 2008;**358**:1547–1559.
470. Thomopoulos C, Parati G, Zanchetti A. Effects of blood pressure lowering on outcome incidence in hypertension. 1. Overview, meta-analyses, and meta-regression analyses of randomized trials. *J Hypertens* 2014;**32**:2285–2295.
471. Williamson JD, Supiano MA, Applegate WB, Berlowitz DR, Campbell RC, Chertow GM, Fine LJ, Haley WE, Hawfield AT, Ix JH, Kitzman DW, Kostis JB, Krousel-Wood MA, Launer LJ, Oparil S, Rodriguez CJ, Roumie CL, Shorr RI, Sink KM, Wadley VG, Whelton PK, Whittle J, Woolard NF, Wright JT Jr, Pajewski NM; SPRINT Research Group. Intensive vs standard blood pressure control and cardiovascular disease outcomes in adults aged ≥ 75 years: a randomized clinical trial. *JAMA* 2016;**315**:2673–2682.
472. Odden MC, McClure LA, Sawaya BP, White CL, Peralta CA, Field TS, Hart RG, Benavente OR, Pergola PE. Achieved blood pressure and outcomes in the secondary prevention of small subcortical strokes trial. *Hypertension* 2016;**67**:63–69.
473. Witberg G, Regev E, Chen S, Assali A, Barbash IM, Planer D, Vaknin-Assa H, Guetta V, Vukasinovic V, Orvin K, Danenberg HD, Segev A, Kornowski R. The prognostic effects of coronary disease severity and completeness of revascularization on mortality in patients undergoing transcatheter aortic valve replacement. *JACC Cardiovasc Interv* 2017;**10**:1428–1435.
474. Chakravarty T, Sharma R, Abramowitz Y, Kapadia S, Latif A, Jililahi H, Poddar KL, Giustino G, Ribeiro HB, Tchetche D, Monteil B, Testa L, Tarantini G, Facchin M, Lefevre T, Lindman BR, Hariri B, Patel J, Takahashi N, Matar G, Mirocha J, Cheng W, Tuzcu ME, Sievert H, Rodes-Cabau J, Colombo A, Finkelstein A, Fajadet J, Makkar RR. Outcomes in patients with transcatheter aortic valve replacement and left main stenting: the TAVR-LM registry. *J Am Coll Cardiol* 2016;**67**:951–960.
475. Rafique AM, Biner S, Ray I, Forrester JS, Tolstrup K, Siegel RJ. Meta-analysis of prognostic value of stress testing in patients with asymptomatic severe aortic stenosis. *Am J Cardiol* 2009;**104**:972–977.
476. Baumgartner H, Falk V, Bax JJ, De Bonis M, Hamm C, Holm PJ, Jung B, Lancellotti P, Lansac E, Rodriguez Munoz D, Rosenhek R, Sjogren J, Tornos Mas P, Vahanian A, Walther T, Wendler O, Windecker S, Zamorano JL. 2017 ESC/EACTS Guidelines for the management of valvular heart disease. *Eur Heart J* 2017;**38**:2739–2791.
477. Zimmer RJ, Lee MS. Transplant coronary artery disease. *JACC Cardiovasc Interv* 2010;**3**:367–377.
478. Okada K, Fearon WF, Luikart H, Kitahara H, Otogiri K, Tanaka S, Kimura T, Yock PG, Fitzgerald PJ, Yeung AC, Valentine HA, Khush KK, Honda Y. Attenuated-signal plaque progression predicts long-term mortality after heart transplantation: IVUS assessment of cardiac allograft vasculopathy. *J Am Coll Cardiol* 2016;**68**:382–392.
479. Luc JGY, Choi JH, Rizvi SA, Phan K, Moncho Escriva E, Patel S, Reeves GR, Boyle AJ, Entwistle JW, Morris RJ, Massey HT, Tchanchaleishvili V. Percutaneous coronary intervention versus coronary artery bypass grafting in heart transplant recipients with coronary allograft vasculopathy: a systematic review and meta-analysis of 1,520 patients. *Ann Cardiothorac Surg* 2018;**7**:19–30.
480. Zamorano JL, Lancellotti P, Rodriguez Munoz D, Aboyans V, Asteggiano R, Galderisi M, Habib G, Lenihan DJ, Lip GYH, Lyon AR, Lopez Fernandez T, Mohty D, Piepoli MF, Tamargo J, Torbicki A, Suter TM. 2016 ESC Position Paper on cancer treatments and cardiovascular toxicity developed under the auspices of the ESC Committee for Practice Guidelines: The Task Force for cancer treatments and cardiovascular toxicity of the European Society of Cardiology (ESC). *Eur Heart J* 2016;**37**:2768–2801.
481. Emerging Risk Factors Collaboration, Sarwar N, Gao P, Seshasai SR, Gobin R, Kaptoge S, Di Angelantonio E, Ingelsson E, Lawlor DA, Selvin E, Stampfer M, Stehouwer CD, Lewington S, Pennells L, Thompson A, Sattar N, White IR, Ray KK, Danesh J. Diabetes mellitus, fasting blood glucose concentration, and risk of vascular disease: a collaborative meta-analysis of 102 prospective studies. *Lancet* 2010;**375**:2215–2222.
482. Thomopoulos C, Parati G, Zanchetti A. Effects of blood-pressure-lowering treatment on outcome incidence in hypertension: 10 - Should blood pressure management differ in hypertensive patients with and without diabetes mellitus? Overview and meta-analyses of randomized trials. *J Hypertens* 2017;**35**:922–944.
483. Shepherd J, Barter P, Carmena R, Deedwania P, Fruchart JC, Haffner S, Hsia J, Breazna A, LaRosa J, Grundy S, Waters D. Effect of lowering LDL cholesterol substantially below currently recommended levels in patients with coronary heart disease and diabetes: the Treating to New Targets (TNT) study. *Diabetes Care* 2006;**29**:1220–1226.
484. ADVANCE Collaborative Group, Patel A, MacMahon S, Chalmers J, Neal B, Billot L, Woodward M, Marre M, Cooper M, Glasziou P, Grobbee D, Hamet P, Harrap S, Heller S, Liu L, Mancia G, Mogensen CE, Pan C, Poulter N, Rodgers A, Williams B, Bompoint S, de Galan BE, Joshi R, Travert F. Intensive blood

- glucose control and vascular outcomes in patients with type 2 diabetes. *N Engl J Med* 2008;**358**:2560–2572.
485. Zinman B, Wanner C, Lachin JM, Fitchett D, Bluhmki E, Hantel S, Matthews M, Devins T, Johansen OE, Woerle HJ, Broedl UC, Inzucchi SE; EMPA-REG OUTCOME Investigators. Empagliflozin, cardiovascular outcomes, and mortality in type 2 diabetes. *N Engl J Med* 2015;**373**:2117–2128.
 486. Neal B, Perkovic V, Matthews DR, Mahaffey KW, Fulcher G, Meininger G, Erondou N, Desai M, Shaw W, Vercrucyze F, Yee J, Deng H, de Zeeuw D; CANVAS-R Trial Collaborative Group. Rationale, design and baseline characteristics of the CANagliflozin cardioVascular Assessment Study-Renal (CANVAS-R): a randomized, placebo-controlled trial. *Diabetes Obes Metab* 2017;**19**:387–393.
 487. Neal B, Perkovic V, Mahaffey KW, de Zeeuw D, Fulcher G, Erondou N, Shaw W, Law G, Desai M, Matthews DR; CANVAS Program Collaborative Group. Canagliflozin and cardiovascular and renal events in type 2 diabetes. *N Engl J Med* 2017;**377**:644–657.
 488. Marso SP, Daniels GH, Brown-Frandsen K, Kristensen P, Mann JF, Nauck MA, Nissen SE, Pocock S, Poulter NR, Ravn LS, Steinberg WM, Stockner M, Zinman B, Bergenstal RM, Buse JB; LEADER Steering Committee; LEADER Trial Investigators. Liraglutide and cardiovascular outcomes in type 2 diabetes. *N Engl J Med* 2016;**375**:311–322.
 489. Marso SP, Bain SC, Consoi A, Eliaschewitz FG, Jodar E, Leiter LA, Lingvay I, Rosenstock J, Seufert J, Warren ML, Woo V, Hansen O, Holst AG, Pettersson J, Vilsboll T; SUSTAIN-6 Investigators. Semaglutide and cardiovascular outcomes in patients with type 2 diabetes. *N Engl J Med* 2016;**375**:1834–1844.
 490. Hernandez AF, Green JB, Janmohamed S, D'Agostino RB, Sr., Granger CB, Jones NP, Leiter LA, Rosenberg AE, Sigmon KN, Somerville MC, Thorpe KM, McMurray JJV, Del Prato S; Harmony Outcomes committees and investigators. Albiglutide and cardiovascular outcomes in patients with type 2 diabetes and cardiovascular disease (Harmony Outcomes): a double-blind, randomised placebo-controlled trial. *Lancet* 2018;**392**:1519–1529.
 491. Kang SH, Park GM, Lee SW, Yun SC, Kim YH, Cho YR, Park HW, Suh J, Yang DH, Kang JW, Lim TH, Jung CH, Koh EH, Lee WJ, Kim MS, Lee KU, Park JY. Long-term prognostic value of coronary CT angiography in asymptomatic type 2 diabetes mellitus. *JACC Cardiovasc Imaging* 2016;**9**:1292–1300.
 492. Clerc OF, Fuchs TA, Stehli J, Benz DC, Grani C, Messerli M, Giannopoulos AA, Buechel RR, Luscher TF, Pazhenkottil AP, Kaufmann PA, Gaemperli O. Non-invasive screening for coronary artery disease in asymptomatic diabetic patients: a systematic review and meta-analysis of randomised controlled trials. *Eur Heart J Cardiovasc Imaging* 2018;**19**:838–846.
 493. Lee JM, Kang J, Lee E, Hwang D, Rhee TM, Park J, Kim HL, Lee SE, Han JK, Yang HM, Park KW, Na SH, Kang HJ, Koo BK, Kim HS. Chronic kidney disease in the second-generation drug-eluting stent era: pooled analysis of the Korean Multicenter Drug-Eluting Stent Registry. *JACC Cardiovasc Interv* 2016;**9**:2097–2109.
 494. Fox CS, Matsushita K, Woodward M, Bilo HJ, Chalmers J, Heerspink HJ, Lee BJ, Perkins RM, Rossing P, Sairenchi T, Tonelli M, Vassalotti JA, Yamagishi K, Coresh J, de Jong PE, Wen CP, Nelson RG; Chronic Kidney Disease Prognosis Consortium. Associations of kidney disease measures with mortality and end-stage renal disease in individuals with and without diabetes: a meta-analysis. *Lancet* 2012;**380**:1662–1673.
 495. Schmidt A, Stefanelli T, Schuster E, Mayer G. Informational contribution of non-invasive screening tests for coronary artery disease in patients on chronic renal replacement therapy. *Am J Kidney Dis* 2001;**37**:56–63.
 496. Bangalore S. Stress testing in patients with chronic kidney disease: the need for ancillary markers for effective risk stratification and prognosis. *J Nucl Cardiol* 2016;**23**:570–574.
 497. Smilowitz NR, Gupta N, Guo Y, Mauricio R, Bangalore S. Management and outcomes of acute myocardial infarction in patients with chronic kidney disease. *Int J Cardiol* 2017;**227**:1–7.
 498. Bangalore S, Guo Y, Samadashvili Z, Blecker S, Xu J, Hannan EL. Revascularization in patients with multivessel coronary artery disease and chronic kidney disease: everolimus-eluting stents versus coronary artery bypass graft surgery. *J Am Coll Cardiol* 2015;**66**:1209–1220.
 499. Wang Y, Zhu S, Gao P, Zhang Q. Comparison of coronary artery bypass grafting and drug-eluting stents in patients with chronic kidney disease and multivessel disease: a meta-analysis. *Eur J Intern Med* 2017;**43**:28–35.
 500. Palmer SC, Navaneethan SD, Craig JC, Johnson DW, Perkovic V, Hegbrant J, Strippoli GF. HMG CoA reductase inhibitors (statins) for people with chronic kidney disease not requiring dialysis. *Cochrane Database Syst Rev* 2014;**5**:CD007784.
 501. Lv J, Ehteshami P, Sarnak MJ, Tighiouart H, Jun M, Ninomiya T, Foote C, Rodgers A, Zhang H, Wang H, Strippoli GF, Perkovic V. Effects of intensive blood pressure lowering on the progression of chronic kidney disease: a systematic review and meta-analysis. *CMAJ* 2013;**185**:949–957.
 502. Klag MJ, Whelton PK, Randall BL, Neaton JD, Brancati FL, Ford CE, Shulman NB, Stamler J. Blood pressure and end-stage renal disease in men. *N Engl J Med* 1996;**334**:13–18.
 503. Marenzi G, Assanelli E, Campodonico J, Lauri G, Marana I, De Metrio M, Moltrasio M, Grazi M, Rubino M, Veglia F, Fabbicchi F, Bartorelli AL. Contrast volume during primary percutaneous coronary intervention and subsequent contrast-induced nephropathy and mortality. *Ann Intern Med* 2009;**150**:170–177.
 504. Laskey WK, Jenkins C, Selzer F, Marroquin OC, Wilensky RL, Glaser R, Cohen HA, Holmes DR Jr; NHLBI Dynamic Registry Investigators. Volume-to-creatinine clearance ratio: a pharmacokinetically based risk factor for prediction of early creatinine increase after percutaneous coronary intervention. *J Am Coll Cardiol* 2007;**50**:584–590.
 505. Malkin CJ, Prakash R, Chew DP. The impact of increased age on outcome from a strategy of early invasive management and revascularisation in patients with acute coronary syndromes: retrospective analysis study from the ACACIA registry. *BMJ Open* 2012;**2**:e000540.
 506. Vranckx P, Frigoli E, Rothenbuhler M, Tomassini F, Garducci S, Ando G, Picchi A, Sganzerla P, Paggi A, Ugo F, Ausiello A, Sardella G, Franco N, Nazzaro M, de Cesare N, Tosi P, Falcone C, Vigna C, Mazzarotto P, Di Lorenzo E, Moretti C, Campo G, Penzo C, Pasquetto G, Heg D, Juni P, Windecker S, Valgimigli M; MATRIX Investigators. Radial versus femoral access in patients with acute coronary syndromes with or without ST-segment elevation. *Eur Heart J* 2017;**38**:1069–1080.
 507. Cantor WJ, Mehta SR, Yuan F, Dzavik V, Worthley M, Niemela K, Valentin V, Fung A, Cheema AN, Widimsky P, Natarajan M, Jedrzejewski B, Jolly SS. Radial versus femoral access for elderly patients with acute coronary syndrome undergoing coronary angiography and intervention: insights from the RIVAL trial. *Am Heart J* 2015;**170**:880–886.
 508. Varenne O, Cook S, Sideris G, Kedev S, Cuisset T, Carrie D, Hovasse T, Garot P, El Mahmoud R, Spaulding C, Helft G, Diaz Fernandez JF, Brugaletta S, Pinar-Bermudez E, Mauri Ferre J, Commeau P, Teiger E, Bogaerts K, Sabate M, Morice MC, Sinnaeve PR; SENIOR investigators. Drug-eluting stents in elderly patients with coronary artery disease (SENIOR): a randomised single-blind trial. *Lancet* 2018;**391**:41–50.
 509. Urban P, Meredith IT, Abizaid A, Pocock SJ, Carrie D, Naber C, Lipiecki J, Richard G, Iniguez A, Brunel P, Valdes-Chavarri M, Garot P, Talwar S, Berland J, Abdellaoui M, Eberli F, Oldroyd K, Zambahari R, Gregson J, Greene S, Stoll HP, Morice MC; LEADERS FREE Investigators. Polymer-free drug-coated coronary stents in patients at high bleeding risk. *N Engl J Med* 2015;**373**:2038–2047.
 510. Kim ES, Carrigan TP, Menon V. Enrollment of women in National Heart, Lung, and Blood Institute-funded cardiovascular randomized controlled trials fails to meet current federal mandates for inclusion. *J Am Coll Cardiol* 2008;**52**:672–673.
 511. Ricci B, Cenko E, Vasiljevic Z, Stankovic G, Kedev S, Kalpak O, Vavlukis M, Zdravkovic M, Hinic S, Milicic D, Manfrini O, Badimon L, Bugiardini R. Acute coronary syndrome: the risk to young women. *J Am Heart Assoc* 2017;**6**:e007519.
 512. Cenko E, Yoon J, Kedev S, Stankovic G, Vasiljevic Z, Krljanac G, Kalpak O, Ricci B, Milicic D, Manfrini O, van der Schaar M, Badimon L, Bugiardini R. Sex differences in outcomes after STEMI: effect modification by treatment strategy and age. *JAMA Intern Med* 2018;**178**:632–639.
 513. Khan NA, Daskalopoulou SS, Karp I, Eisenberg MJ, Pelletier R, Tsadok MA, Dasgupta K, Norris CM, Pilote L; GENESIS PRAXY Team. Sex differences in acute coronary syndrome symptom presentation in young patients. *JAMA Intern Med* 2013;**173**:1863–1871.
 514. Oertelt-Prigione S, Seeland U, Kendel F, Rucke M, Floel A, Gaissmaier W, Heim C, Schnabel R, Stangl V, Regitz-Zagrosek V. Cardiovascular risk factor distribution and subjective risk estimation in urban women—the BEFRI study: a randomized cross-sectional study. *BMC Med* 2015;**13**:52.
 515. Davis M, Diamond J, Montgomery D, Krishnan S, Eagle K, Jackson E. Acute coronary syndrome in young women under 55 years of age: clinical characteristics, treatment, and outcomes. *Clin Res Cardiol* 2015;**104**:648–655.
 516. Aggeli C, Polyarchou K, Felekos I, Zisimos K, Venieri E, Verveniotes A, Varvarousis D, Toutouzias K, Tsiamis E, Tousoulis D. Effect of gender on the prognostic value of dobutamine stress myocardial contrast echocardiography. *Hellenic J Cardiol* 2017;**58**:419–424.
 517. Morice MC, Mikhail GW, Mauri I, Ferre F, Modena MG, Strasser RH, Grinfeld L, Sudhir K, Stuteville M, Papeleu P, Li D, Rutledge D, Windecker S. SPIRIT Women, evaluation of the safety and efficacy of the XIENCE V everolimus-eluting stent system in female patients: referral time for coronary intervention and 2-year clinical outcomes. *EuroIntervention* 2012;**8**:325–335.
 518. Duvernoy CS, Smith DE, Manohar P, Schaefer A, Kline-Rogers E, Share D, McNamara R, Gurm HS, Moscucci M. Gender differences in adverse outcomes after contemporary percutaneous coronary intervention: an analysis from the

- Blue Cross Blue Shield of Michigan Cardiovascular Consortium (BMC2) percutaneous coronary intervention registry. *Am Heart J* 2010;**159**:677–683 e671.
519. Giustino G, Baber U, Salianski O, Sartori S, Stone GW, Leon MB, Aquino M, Stefanini GG, Steg PG, Windecker S, M OD, Wijns W, Serruys PW, Valgimigli M, Morice MC, Camenzind E, Weisz G, Smits PC, Kandzari D, Von Birgelen C, Dangas GD, Cha JY, Galatius S, Jeger RV, Kimura T, Mikhail GW, Itchhaporia D, Mehta L, Ortega R, Kim HS, Kastrati A, Genereux P, Chieffo A, Mehran R. Safety and efficacy of new-generation drug-eluting stents in women at high risk for atherothrombosis: from the Women in Innovation and Drug-Eluting Stents collaborative patient-level pooled analysis. *Circ Cardiovasc Interv* 2016;**9**:e002995.
520. Filardo G, Hamman BL, Pollock BD, da Graca B, Sass DM, Phan TK, Edgerton J, Prince SL, Ring WS. Excess short-term mortality in women after isolated coronary artery bypass graft surgery. *Open Heart* 2016;**3**:e000386.
521. Arif R, Farag M, Gertner V, Szabo G, Weymann A, Veres G, Ruhparwar A, Bekeredjian R, Bruckner T, Karck M, Kallenbach K, Beller CJ. Female gender and differences in outcome after isolated coronary artery bypass graft surgery: does age play a role? *PLoS One* 2016;**11**:e0145371.
522. Banks E, Canfell K. Invited commentary: hormone therapy risks and benefits—the Women’s Health Initiative findings and the postmenopausal estrogen timing hypothesis. *Am J Epidemiol* 2009;**170**:24–28.
523. Clarkson TB, Melendez GC, Appt SE. Timing hypothesis for postmenopausal hormone therapy: its origin, current status, and future. *Menopause* 2013;**20**:342–353.
524. Arora RR, Chou TM, Jain D, Fleishman B, Crawford L, McKiernan T, Nesto R, Ferrans CE, Keller S. Effects of enhanced external counterpulsation on Health-Related Quality of Life continue 12 months after treatment: a substudy of the Multicenter Study of Enhanced External Counterpulsation. *J Investig Med* 2002;**50**:25–32.
525. Verheye S, Jolicoeur EM, Behan MW, Pettersson T, Sainsbury P, Hill J, Vrolix M, Agostoni P, Engstrom T, Labinaz M, de Silva R, Schwartz M, Meyten N, Uren NG, Doucet S, Tanguay JF, Lindsay S, Henry TD, White CJ, Edelman ER, Banai S. Efficacy of a device to narrow the coronary sinus in refractory angina. *N Engl J Med* 2015;**372**:519–527.
526. Zipes DP, Svorkdal N, Berman D, Boertz-Marx R, Henry T, Lerman A, Ross E, Turner M, Irwin C. Spinal cord stimulation therapy for patients with refractory angina who are not candidates for revascularization. *Neuromodulation* 2012;**15**:550–558; discussion 558–559.
527. Denby C, Groves DG, Eleuteri A, Tsang HK, Leach A, Hammond C, Bridson JD, Fisher M, Elt M, Laflin R, Fisher AC. Temporary sympathectomy in chronic refractory angina: a randomised, double-blind, placebo-controlled trial. *Br J Pain* 2015;**9**:142–148.
528. Henry TD, Losordo DW, Traverse JH, Schatz RA, Jolicoeur EM, Schaer GL, Clare R, Chiswell K, White CJ, Fortuin FD, Kereiakes DJ, Zeiher AM, Sherman W, Hunt AS, Povsic TJ. Autologous CD34+ cell therapy improves exercise capacity, angina frequency and reduces mortality in no-option refractory angina: a patient-level pooled analysis of randomized double-blinded trials. *Eur Heart J* 2018;**39**:2208–2216.
529. Briones E, Lacalle JR, Marin-Leon I, Rueda JR. Transmyocardial laser revascularization versus medical therapy for refractory angina. *Cochrane Database Syst Rev* 2015;**2**:CD003712.